

PROFESSIONAL TOOLS

**FORCE**

**GENERAL CATALOGUE 06/07**





Trolleys,  
Tool Boxes,  
Suitcases,  
Workbenches,  
Cabinets

Page  
**1-01~1-12**



1/2"  
Socket sets,  
Bits,  
Sockets,  
Ratchet handles  
Accessories

Page  
**6-01~6-76**



Automotive tools,  
Chisels,  
Pliers,  
Clamps,  
Pullers,  
Special tools

Page  
**2-01~2-70**



3/4"  
Socket sets,  
Sockets,  
Ratchet handles  
Accessories

Page  
**7-01~7-06**



Spanners,  
Screwdrivers,  
Allen keys,  
Wrenches

Page  
**3-01~3-64**



1"  
Socket sets,  
Sockets,  
Ratchet handles  
Accessories

Page  
**8-01~8-04**



1/4"  
Socket sets,  
Bits,  
Sockets,  
Ratchet handles  
Accessories

Page  
**4-01~4-38**



Air impact tools  
Cordless impact tools

Page  
**9-01~9-52**



3/8"  
Socket sets,  
Bits,  
Sockets,  
Ratchet handles  
Accessories

Page  
**5-01~5-30**



*Anything you need for tools...*



Part No.	Page	Part No.	Page	Part No.	Page	Part No.	Page
121	4-23	2086YC	3-03	2141T	3-08	2502-7	4-18
121S	4-26	2087	3-04	2142	1-11	2502-9	4-18
122	4-23	2088	3-04	2142	3-08	2571	4-18
122S	4-26	2088T	3-04	2142YC	1-11	2611A	4-19
123	4-23	2095	1-10	2142YC	3-08	2611B	4-19
123S	4-26	2095	3-04	2143	3-08	2641	4-20
124	4-23	2096	1-10	2144Q	4-06	26490	9-30
124R	4-26	2096	3-05	2161	3-09	2741	4-20
124S	4-26	2097	1-10	2203	4-06	2742	4-21
125	4-24	2097	3-05	2203-5	4-06	2742-18	4-21
126	4-25	2097B	1-10	2203-72	4-07	2751	3-10
127	4-25	2097B	3-05	2203-72-5	4-07	2752	3-10
128	4-25	2097S	1-11	2204	3-09	2753	3-10
12F	4-26	2097S	3-05	2253	4-07	2753T	3-10
151	5-17	2101	4-03	2253-72	4-08	3051	5-01
152	5-17	21010	4-04	2261	3-09	3062	5-01
153	5-17	21011	4-04	2281	4-08	3063	9-05
154	5-17	21012	4-04	2281-5	4-08	3064	5-01
156	5-18	21012T	4-04	2281-72	4-09	3065	5-01
157	5-18	21013	4-04	2281-72-5	4-09	3065S	5-01
174	6-58	2101L	4-03	2292	4-09	3071	5-01
176	6-58	21021	4-22	2292-7	4-09	30710S	5-03
177	6-59	21022	4-22	2292-9	4-09	30711	5-03
178	6-59	2106	3-05	2303	4-10	30712	5-03
179	6-60	2108	1-11	2304	4-10	3072	5-02
196	6-58	2108	3-05	2312	4-11	3073	5-02
2044	3-01	2109	1-11	2312-5	4-11	3074	5-02
2044S	3-01	2109	3-06	2312-72	4-11	3075	5-02
2044ST	3-01	21110	4-05	2312-72-5	4-11	3075S	5-02
2045	4-01	21111	4-05	2313	4-12	3075SK	5-02
2046	4-01	21112	4-05	2314A	4-12	3077S	5-02
2061	3-01	21113	4-05	2314B	4-12	3078	5-03
2061T	3-01	21113T	4-05	2315	4-13	3081	5-04
2062	4-01	2111I	4-04	2331	4-13	3082	5-04
2064	3-01	2112I	4-04	23452	9-06	3082S	5-04
2065	3-01	2119	3-06	23652	9-06	3083	9-05
2066	3-02	2119T	3-06	2402	4-14	3083S	9-05
2071	4-01	2125	1-11	2405Q	4-14	3084	9-05
20712	3-02	2125	3-06	241	9-18	3084S	9-05
2073	4-02	2125P1	2-42	2411	4-15	3091	5-04
2073S	4-02	2126	1-11	2411-5	4-15	3092	5-04
2081	4-02	2126	3-06	242	9-18	3093	5-04
20810	3-04	2133	4-06	2421	4-15	3093S	5-04
20810B	3-04	2134	1-11	2421BF	4-16	3094	5-05
2081A	4-02	2134	3-07	2421F	4-16	3095	5-05
2081B	4-02	2137	1-11	244	9-19	3101	5-05
2081C	4-03	2137	3-07	244060	9-19	3103	5-05
2081D	4-03	2137T	1-11	246	9-19,-20	3105	5-06
2083	4-03	2137T	3-07	246060	9-20	3108Q	5-06
2084B	3-02	2137TYC	3-07	2461	4-17	3111	5-06
2084YC	3-02	2137YC	1-11	2461-5	4-17	3112	5-06
2085B	3-03	2137YC	3-07	2462	4-17	3114	5-06
2085YC	3-03	2138Q	4-06	2462-7	4-17	3121	5-07
2086B	3-03	2141	1-11	2462-9	4-17	3122Q	5-07
2086TB	3-03	2141	3-07	248	9-20	3142	5-07
2086TYC	3-03	2141T	1-11	2502	4-18	3151	5-07

Part No.	Page	Part No.	Page	Part No.	Page	Part No.	Page
3171	5-08	346	6-62,-63	41021-9	6-45	4172	6-12
3171T	5-08	347	6-64	4106	6-08	4173	6-13
3193	5-08	348	6-64	4106S	6-08	4173-5	6-13
321	4-27	348..T	2-52	4107	9-14	4173-9	6-13
3212	5-08	348..T	6-65	41071	6-45	4173S	6-13
3213	5-09	349	6-65	41071-9	6-46	4173S-5	6-13
322	4-27	3521	5-14	4107S	9-14	4173S-9	6-13
3222	5-09	3551	5-15	4108	9-14	4181	6-13
3224	5-09	3551-5	5-15	41081	6-46	4181-7	6-13
323	4-27	3551-9	5-15	41081-5	6-47	4181-9	6-14
3232	5-09	3571	5-15	41081-9	6-47	4192	6-14
3232-7	5-10	3571-5	5-15	41082	6-47	4193	9-18
3232-9	5-10	3571-72	5-16	41082-9	6-48	4194	6-14
324	4-27	3611	5-16	4109	9-14	4194-7	6-14
3251	5-10	3611-5	5-16	4109S	9-14	4194-9	6-14
3251-5	5-10	4031	2-01	4111	6-08	4205	9-47
3251-5-18	5-10	4041	6-01	4111S	6-08	4205D	9-47
3251-72	5-10	4042	6-01	4112	6-09	4211	6-15
3251-72-5	5-10	4051	6-01	4113	6-09	4212	6-15
3251-9	5-10	4056	6-01	4116	6-09	4212-7	6-15
3251Q	5-11	4057	6-02	4117	9-15	4212-9	6-15
326	4-27	4059	6-02	4118	9-15	4213	6-16
3261	5-11	4061	6-02	4118-2	9-15	4214	6-16
3261-7	5-11	40612	6-03	4119	9-16	4214-7	6-16
3261-9	5-11	40613	6-03	4122	6-09	4214-9	6-16
327	4-28	40613-23	6-03	4124Q	6-10	4222	6-17
32F	4-28	4062	6-02	4125	9-45	4223	6-17
331	5-19	4066	6-03	4125D	9-46	4223-7	6-17
332	5-19	4071	6-04	4141	6-10	4223-9	6-17
3322	5-11	4072	6-04	4142	9-16	4225	6-18
3322-15	5-12	4073	9-12	41421	6-48	4234A	6-50
3322-23	5-12	4074	6-04	41421-9	6-49	4234A+2421	6-51
3322-24	5-12	4075	6-04	4142-3	9-17	4234A+4102	6-51
333	5-19	4077	9-12	4142-4	9-17	4234B	6-52
334	5-19	4078	9-13	4142B	9-16	4234B+2641	6-52
335	5-20	4081	6-04	4143	6-10	4234B+3251-5	6-53
3351	5-12	4081-3	6-04	4143-9	6-10	4234B+3361	6-53
3351-5	5-12	4082	6-05	41451D	9-18	4234B+4411	6-54
336	5-20	4082S	6-05	41451S	9-18	4234B+5161	6-54
336..U	2-52	4083	6-05	4155	6-10	4243	6-18
3361	5-13	4084	6-05	4156	6-11	4243-5	6-18
3361-7	5-13	4084S	6-05	4157	6-11	4243-9	6-18
3361-9	5-13	4085	6-05	4158	6-11	4243B	6-55
337	5-21	4085S	6-06	4161	6-11	4243B+2203-72-5	6-55
338	5-21	4091	6-06	4161-7	6-11	4243B+2253-72	6-56
339	5-21	4091S	6-06	4161-9	6-11	4243B+2281-72-5	6-56
3391	5-13	4092	6-07	4162	6-12	4243B+2571	6-57
3391-5	5-13	4093	6-07	4162-5	6-12	4243S	6-19
33F	5-21	4095	6-07	4162-7	6-12	4243S-5	6-19
341	6-60	4101	6-07	41631D	6-50	4243S-9	6-19
342	6-60	41012	9-14	41631D-7	6-50	4245	6-19
343	6-60,-61	41013	9-15	41631D-9	6-50	4245-7	6-19
344	6-61	41014Q	6-08	41631S	6-49	4245-9	6-19
3441	5-14	4101S	6-07	41631S-7	6-49	4245B	6-20
34410508B	2-52	4102	6-08	41631S-9	6-49	4245B-7	6-20
345	6-62	41021	6-44	4171	6-12	4245B-9	6-20
3451	5-14						



Part No.	Page	Part No.	Page	Part No.	Page	Part No.	Page
4245BS	6-21	448	9-23	5021	2-01	50610	3-14
4245BS-7	6-21	44885	9-23	50217BC	1-02	50610S	3-14
4245S	6-20	4511	6-31	50217BC-286	1-05	50612	2-06
4245S-7	6-20	4511-5	6-31	50217C	1-02	50613	2-06
4245S-9	6-20	4511-7	6-31	50217C-286	1-05	50614	2-06
4246	6-21	4512	6-32	50217RC	1-02	50616S	3-14
4246-5	6-21	4512-5	6-32	50217RC-286	1-05	50617	3-14
4246-9	6-21	4512-9	6-32	50218BC	1-02	50619	1-12
4246S	6-21	4541	6-32	50218C	1-02	5062	3-11
4246S-5	6-21	4541-5	6-32	50218R	1-02	50622	3-12
425	9-04	4541-7	6-33	50223	1-01	50623	3-12
4252	6-22	455	9-44	50223R	1-01	50624	3-12
426	9-04	4601	6-33	50225	1-01	5063	3-12
4262	6-22	4601-5	6-33	50225R	1-01	5063T	3-12
4262-7	6-22	4601-9	6-33	5023	2-01	5064	2-05
4262-9	6-22	461	9-30	50234	1-03	5064L	2-06
4281	6-23	4611	6-34	50234-107	1-04	5065	3-13
4283	6-23	4611-5	6-34	50234-30	9-49	5066	3-13
4285	9-48	4611-7	6-34	50235	1-01	5066S	3-13
4291	6-24	4611-72	6-35	50235-101	1-04	5067	3-13
4291-5	6-24	46190	9-30	50253	1-03	5067S	3-13
4291-7	6-24	4641	6-35	50254	1-03	5068	3-13
4321	6-24	465	9-30,-31	50254-177	1-04	5068S	3-13
4321-7	6-24	4651	6-36	50318	1-02	5069	3-14
435	9-07	465100	9-31	50318-437	1-05	5069S	3-14
4351	6-25	4652	6-36	50318B	1-02	5071	3-15
4352	6-25	466110	2-52	50318B-437	1-05	50710S	3-18
43563	9-07	466110	9-32	50318R	1-02	50711XL	3-18
436	9-08	468	9-32	50318R-437	1-05	50711XLB	3-18
4401	6-26	4682	6-37	5033	3-11	50711XLS	3-18
4401C	6-26	4682-5	6-37	5034	2-02	50711XLS	3-18
4401CT	6-26	4682-9	6-37	5036	2-02	50713	1-11
4401T	6-26	4683	6-38	5036A	2-02	50714	3-19
4403	6-27	4731	6-38	5038	2-02	5071T	3-15
441	9-20	4761	6-39	5041	3-11	5072	3-15
4411	6-27	4761-5	6-39	5042	2-03	5072BF	3-15
4412	6-28	4761-9	6-39	5042S	2-03	5072F	3-15
4412-5	6-28	4771	6-40	5043A	2-03	5072L	3-15
4421	6-28	481	9-37	5044	3-11	5072LB	3-16
4421C	6-29	48190	9-37	5045	2-03	5072LBS	3-16
4421CT	6-29	482	9-37	5046	2-03	5072LS	3-15
4421T	6-28	4821	6-41	5047	2-04	5072S	3-15
4422Q	6-29	4821-5	6-41	5047P1	2-32	5072XL	3-16
44322	2-52	4821-9	6-41	5047P2	2-32	5072XLB	3-16
4441C	6-30	484	9-38	5047P3	2-32	5072XLBS	3-16
4441CT	6-30	485	9-38	5047P4	2-32	5072XLS	3-16
4442C	6-30	485100	9-39	5048	1-11	5074	3-16
4442CT	6-30	48580	9-39	5051	2-04	5075	3-17
445	9-21	488	9-39	5052	3-11	5076	3-17
445150..C	9-22	4911	6-42	5053	2-04	5076F	3-17
44552	9-21	4911-9	6-42	5054	2-04	5076S	3-17
44552..TH	9-21	4921	6-43	5055	2-05	5077	3-17
44585	9-21	4941	6-43	5055P1	2-26	5077S	3-17
44585..C	9-22	4941-5	6-44	5055P4	2-25	5078	2-06
44585..TH	9-22	4941-9	6-44	5056	2-05	5079S	3-18
446	9-23	50131	1-12	5061	2-05	5081	3-19

Part No.	Page	Part No.	Page	Part No.	Page	Part No.	Page
50810	3-21	5111	3-27	52Q50	4-32	610110	2-32
50811	3-21	5111S	3-27	5341	3-37	610B	2-32
50812	3-21	5112	3-27	535	5-22	610B..B	2-32
50813	3-21	5112S	3-28	53546	5-22	611	2-33
50814	2-07	5115	3-28	53563	5-22	6111	9-29
50816	1-12	5115S	3-28	536	5-23	6111-1	9-29
50816	3-22	5116	3-28	536...	5-23	6111D	9-29
50817	3-22	5116L	3-28	537	5-23	6111D-1	9-29
5081S	3-19	5116LB	3-29	53763	5-24	611B	2-33
5082	3-19	5116XL	3-29	539	5-24	612	2-33
5083F	3-19	5121	3-29	53963	5-24	612140	2-33
5083TF	3-19	51210	3-30	53Q	5-25	612B	2-33
5084	3-20	51211	3-30	53Q63	5-25	613	2-34
5085	3-20	51213P	3-31	54111	1-11	613A	2-34
5085S	3-20	51214	3-31	54111P1	2-39	613B	2-34
5086	3-20	51214P	3-31	545	6-65	614	2-44
5086S	3-20	51215	3-31	54577	6-66	6141	7-01
5087F	3-20	51215R	3-32	546	6-66	6141-5	7-01
5087TF	3-20	5121S	3-29	54677	6-67	6141B	7-01
50910BS	1-11	5122	2-07	547	6-67	6141B-5	7-01
50910BS	3-24	5123	3-29	54777	6-68	6141S	7-01
50911	1-11	5128P	3-30	548W	6-68	6141SB	7-01
50911	3-25	5131	2-08	549	6-68	615	2-44
50912	1-11	5134	3-32	54977	6-69	616..	2-25
50912	3-25	5135S	3-32	54Q	6-70	617	2-31
50913	3-25	5137	3-33	54Q77	6-70	617L	2-30
5093	3-22	5137S	3-33	5501	3-37	618	2-26
5093L	3-22	5137XL	3-33	565	7-04	61802	2-26
5093LB	3-23	5138	1-12	569	7-04	619	2-56
5093LBS	3-23	5139	1-12	589	8-02	620	2-57
5093LS	3-22	5141	3-33	601235	2-09	62001	2-09
5093S	3-22	5141S	3-33	601250	2-09	6201	7-02
5093XL	3-23	5151	3-33	602	2-23	6201-5	7-02
5093XLB	3-23	5151L	3-34	602..Q	2-23	6201B	7-02
5093XLBS	3-23	5151LT	3-34	603	2-23	6201B-5	7-02
5093XLS	3-23	5151T	3-34	603..Q	2-23	6201S	7-02
5094	3-23	5161	3-34	604	2-23	6201SB	7-02
5096	2-07	5164	3-34	604..Q	2-23	62101	2-58
5096P8..	2-26	5164R	3-35	605	2-23	62102	2-58
5098	3-24	5171	2-08	606	2-24	62103	2-58
5098L	3-24	5172	3-35	606..Q	2-24	62104	2-58
5098LT	3-24	5191	3-35	6061	7-03	62105	2-10
5098T	3-24	5191Q	3-35	607	2-24	62106	2-58
5099L	3-24	5192	3-36	607..Q	2-24	6212	7-03
51010T	1-11	5201	2-09	608	2-51	6212-5	7-03
51010T	3-27	525	4-28	6081	9-28	6212S	7-03
5102	3-25	52550	4-29	6081D	9-28	623	2-57
5102L	3-25	526	4-29	6081DS	9-28	62501	2-59
5102LB	3-26	5261	3-36	6081S	9-28	62502	2-59
5102XL	3-26	5261P	3-36	6082D	9-28	62503	2-59
5102XLB	3-26	52650	4-29	6082DS	9-28	62504	2-59
5103	3-26	527	4-30	609..ABC	2-35	62505	2-59
5103S	3-26	52750	4-30	609..ABO	2-35	62506	2-59
5106B	1-12	529	4-31	609..ASC	2-35	62507	2-60
5106B	3-26	52950	4-31	609..ASO	2-35	62508	2-60
5109S	3-27	52Q	4-32	610	2-32	62509	2-60



Part No.	Page	Part No.	Page	Part No.	Page	Part No.	Page
62510	2-60	65402	2-27	666A01	2-17	6934	2-36
62511	2-60	65403	2-27	666A02	2-17	6936	2-37
62512	2-61	65404	2-27	666A03	2-17	6937	2-37
62513	2-61	65405	2-27	66901	2-31	6938	2-37
62514	2-61	6551..	2-49	66902	2-31	6939	2-37
62515	2-61	6551..L	2-49	66903	2-31	6941	2-38
62516	2-61	6552..L	2-49	67001	2-17	6942	2-38
62518	2-62	6553..	2-49	67101	2-18	6943	2-38
62519	2-62	6553..L	2-49	672	2-18	6944	2-38
62520	2-62	656	2-13	673B	2-34	6945	2-38
62521	2-62	65601	2-56	674	2-18	6951	2-35
62601	2-70	65602	2-56	677..	2-50	6961..	2-34
627	2-57	65603	2-56	678	2-18	6962..	2-34
62701	2-57	656M	2-13	67801	2-39	6963..	2-34
62702	2-10	65701	2-70	67802	2-39	6964..	2-34
628	2-64	65714	2-70	67901	2-45	6965..	2-34
62801	2-63	658	2-13	67902	2-45	6971	2-35
62802	2-63	65901	2-65	67903	2-45	6972	2-35
62805	2-63	65902	2-65	67904	2-45	698..	2-26
62806	2-63	65906	2-65	67905	2-45	6982	2-26
6280723	2-63	6590630	2-65	6801	2-40	6991015	2-48
6280728	2-64	65907	2-66	6802	2-40	711..	3-38
62808..	2-64	6590725	2-66	6803	2-40	711..B	3-38
62809	2-64	65908	2-66	6804	2-40	711..M	3-38
628E..	2-64	6590825	2-66	6804B160	2-40	711..N	3-38
62901	2-57	6590850	2-67	6805	2-40	712..	3-38
63001	2-55	65909	2-68	681500	2-50	712..B	3-39
63002	2-55	65911..	2-67	681A300	2-50	712..M	3-39
63003	2-55	65912..	2-67	681B400	2-50	712..N	3-39
63004	2-55	65913..	2-67	6821	2-51	713..	3-39
63005	2-10	659A..	2-68	684..	2-46	713..B	3-39,-40
63006	2-11	659C2..	2-67	684..A	2-46	713..M	3-40
63006B	2-11	659C3..	2-67	68601	2-28	713..N	3-40
63201	2-31	660	2-44	68602	2-28	714..B	3-40
634	2-70	66101	2-44	68603	2-28	715..B	3-40
634..A	2-70	66201	2-44	68604	2-28	716	3-41
639	2-56	66301	2-25	687	2-24	716..B	3-41
64101	2-11	66302	2-25	6901..	2-41	717	3-41
647	2-47	66303	2-25	6902..	2-41	717..B	3-41
647..W	2-48	664	2-14	6903..	2-41	71817004A	2-49
64701L	2-11	66401	2-69	6904..	2-41	724	3-42
64702L	2-11	66402	2-69	6905..	2-41	725	3-42
64703	2-11	66403	2-69	6907..	2-41	726	3-42
64704	2-12	66404	2-69	6908..	2-41	727	3-42
64705	2-12	664A	2-14	6909..	2-41	731	3-43
64707	2-13	664P	2-14	6911..	2-42	732	3-43
648	2-49	665B	2-16	6912..	2-42	733	3-43
649..	2-46	666..	2-15	6913..	2-42	734	3-43
649..A	2-46	66601	2-16	6914..	2-42	735	3-44
649..B	2-46	66602	2-16	6921..	2-39	736	3-44
65001	2-51	66603	2-16	6922..	2-39	737	3-44
651	2-48	666050	2-68	6923..	2-39	739	3-44
65201	2-44	666075	2-68	6924..	2-39	744	3-44
65202	2-44	666105	2-68	6925..	2-39	750500	2-51
653	2-57	666140	2-69	6931	2-36	751	3-45
65401	2-27	666150	2-69	6932	2-36	752	3-46
				6933	2-36	753	3-46

Part No.	Page	Part No.	Page	Part No.	Page	Part No.	Page
753..A	3-47	802220	4-34	8043..MPP	9-11	8083	5-30
754	3-47	802221	4-34	8043..W	5-28	8084	6-75
755	3-48	802222	4-33	8044	6-73	8084..MPB	9-27
755..A	3-48	802223	4-33	8044..MPB	9-26	8086	7-06
755..Q	3-49	80224	4-33	8044..MPP	9-26	809	5-30
755S	3-49	80225	4-33	8044..R	6-73	809	6-75
756	3-50	80226	4-33	8044..W	6-73	809..MPP	9-44
756..A	3-50	80229	4-33	80454300	6-73	8091	9-36
756..F	3-50	8023...F	5-28	80454430	6-73	8091-1	9-36
757	3-50	8023...S	5-27	8046	7-05	80912..MPP	9-46
757..F	3-50	8023...	5-27	8046..MPB	9-33	8091D	9-37
757..R	3-51	802311	5-27	8046..MPP	9-33	8091D-1	9-37
757S	3-51	802315	5-27	8048	8-03	8091MD	9-36
758	3-51	802318	5-27	8048..MPP	9-42	8092	4-35
758S	3-52	802319	5-27	80521	4-35	80920..MPP	9-48
759	3-52	80232	5-26	80531	5-28	8093	5-30
760	3-52	802321	5-27	80531MPB	9-11	8093..MPB	9-11
761	3-53	802322	5-26	80531MPP	9-11	8093..MPP	9-11
761..A	3-53	802323	5-26	80535	5-29	8094	6-75
762	3-53	80233	5-26	8053585	5-29	8094..MPB	9-27
764	3-53	80234	5-26	80536	5-29	8094..MPP	9-27
764..L	3-54	80235	5-26	80541	6-73	8096	7-06
764..T	3-55	80236	5-26	80541MPB	9-26	8096..MPB	9-34
764..XL	3-54	80239	5-27	80541MPP	9-26	8096..MPP	9-34
765..G	3-56	802411	6-72	80545	6-74	8098	8-03
765..L	3-55	802412	6-72	80545108	6-74	8098..MPB	9-43
765..XL	3-55	802415	6-72	80546	6-74	8098..MPP	9-42
766	3-56	802418	6-72	8056	7-06	8102	4-36
766..L	3-57	80242	6-71	80561MPB	9-33	8103	5-30
766..T	3-56	802421	6-72	80561MPP	9-33	8104	6-75
767	3-57	802422	6-71	8058	8-03	8111	4-36
767..G	3-56	802423	6-71	80581MPB	9-42	8112	4-36
767..L	3-57	80243	6-71	80581MPP	9-42	8113	4-36
768..K	3-57	802433	6-76	806	4-35	812	4-36
76F	3-57	80244	6-71	806	5-29	81225	4-36
774	3-58	80245	6-71	806	6-74	8141	8-01
774..A	3-58	80246	6-72	8073	5-29	8141S	8-01
776	3-58	80249	6-72	8073..B	2-53	8142	4-37
784..B	3-59	8026	7-05	8073..BM	2-53	8143	4-37
784..U	3-59	8028	8-02	8073..M	5-29	8144	4-37
791	3-60	8032	4-35	8073..U	2-54,-55	8145	4-37
792	3-60	8033	5-28	8073..UM	2-54	8148	4-37
793	3-61	8033200L	5-28	8073250..M	2-52	8154	6-75
8012	4-33	8034	6-72	8074	6-75	8156	7-06
8013	5-26	8034250L	6-73	8074..M	2-52	8158650	8-03
8014	6-71	8036	7-05	8074..M	6-75	815A4315	6-76
8014600	6-71	8036450L	7-05	8074..U	2-54,-55	8162	4-37
8016	7-05	8038	8-02	8074..UM	2-54	8163	5-30
8018	8-02	803A4300	6-76	8081	9-35	8164	6-75
802202	4-34	804..U	3-62	8081D	9-35	818	2-31
802202F	4-34	80412..MPP	9-46	8081DS	9-35	8192	4-37
802211	4-34	8042	4-35	8081S	9-35	8193...	5-30
802215	4-34	8042..W	4-35	8082	9-35	8193T	5-30
802218	4-34	80420..MPP	9-48	8082D	9-35	8194	6-76
802219	4-34	8043	5-28	8082DS	9-36	8194T	6-76
80222	4-33	8043...R	5-28	8082S	9-35	8211	8-01



Part No.	Page	Part No.	Page	Part No.	Page	Part No.	Page
8211S	8-01	88001	2-29	K51210F	3-30	T4413	1-08
822..	3-62	88002	2-29	K51216	3-32	T5021	1-08
824..	3-62	88003	2-29	K64706	2-12	T5023	1-08
82421	9-03	88004	2-29	T2045	1-06	T5033	1-08
82422	9-03	88011	2-30	T2046	1-06	T5034	1-08
82431	9-08	88012	2-30	T20712	1-06	T5036	1-08
82432	9-08	88013	2-30	T20810	1-06	T5036A	1-08
82433	9-08	881..	2-31	T20810B	1-06	T5038	1-08
82434	9-09	88201	2-62	T2084B	1-06	T50410	1-08
82441	9-23	88401	2-42	T2084YC	1-06	T5043A	1-08
82442	9-23	88402	2-42	T2085B	1-06	T5044	1-08
825..	3-63	88403	2-42	T2085YC	1-06	T5045	1-08
825121	9-46	88404	2-42	T2086B	1-06	T5046	1-08
82531	9-09	88405	2-43	T2086TB	1-06	T5047	1-08
82532	9-09	88406	2-43	T2086YC	1-06	T5052	1-08
82533	9-09	88407	2-43	T2641	1-06	T5053	1-08
82541	9-24	88408	2-43	T2741	1-06	T5055	1-08
82542	9-24	88424	2-43	T2742	1-06	T5056	1-08
82543	9-24	904U2	2-19	T2742-15	1-06	T5057	1-09
82544	9-24	906U1	2-19	T2742-18	1-06	T50616S	1-09
82545	9-25	910U2	2-19	T30711	1-06	T50617	1-09
82546	9-25	910U3	2-20	T30712	1-06	T50618-18	1-09
82547	9-25	911G3	2-20	T3121	1-06	T50618-24	1-09
82548	9-25	911M1	2-20	T3193	1-06	T50710	1-09
82561	9-32	912U1	2-21	T3212	1-06	T5074	1-09
82563	9-32	912U2	2-21	T3224	1-06	T5075	1-09
82564	9-33	913U1	2-22	T3251-5	1-06	T5079S	1-09
82565	9-33	913U2	2-22	T3251-5-18	1-07	T5081	1-09
82581	9-40	915U3	2-22	T3251-72-5	1-07	T50810	1-09
825810	9-41	915U4	2-22	T3311	1-07	T50811	1-09
825811	9-41	9M1601	2-61	T3322	1-07	T50812	1-09
825812	9-41	9M1602	2-62	T3322-15	1-07	T50813	1-09
825813	9-42	9M1603	2-62	T3322-23	1-07	T50814	1-09
82585	9-40	9U0501..	2-46	T3322-24	1-07	T50817	1-09
82587	9-40	C21114	1-12	T3331	1-07	T5082	1-09
82588	9-40	C3661	1-12	T3361	1-07	T5085	1-09
82589	9-41	C4482	1-12	T3381	1-07	T5085S	1-09
825A41	9-50	C5136	1-12	T3521	1-07	T5089	1-09
826..	3-63	C5142	1-12	T4057	1-07	T5096	1-09
82601	9-26	C5153	1-12	T4057-15	1-07	T5111	1-09
82602	9-26	C5203	1-12	T40612	1-07	T5111S	1-09
826A01	9-50	K2139	9-01	T40613	1-07	T5114	1-09
827..	3-63	K2139-2	9-01	T40613-23	1-07	T51210	1-10
82721	9-03	K2231	9-02	T4116	1-07	T51211	1-10
82731	9-10	K2231-2	9-02	T4119	1-07	T51214	1-10
82732	9-10	K3021	2-01	T4122	1-07	T51215	1-10
82733	9-10	K3133	9-05	T4143	1-07	T51215R	1-10
82734	9-10	K3133-3	9-06	T4193	1-07	T5122	1-10
827A31	9-51	K4032	9-12	T4194	1-07	T5131	1-10
827M..	3-63	K4033	9-12	T4203	1-07	T5134	1-10
828	3-63	K4079	9-13	T4212	1-07	T5135S	1-10
828A21	9-51	K4087	6-06	T4214	1-08	T5161	1-10
828A22	9-52	K4088	9-13	T4214	1-08	T5164	1-10
831..	3-63	K4099	9-13	T4248	1-08	T5164R	1-10
832	2-48	K50411	3-11	T4248S	1-08	T5172	1-10
8334300	6-76	K50625	3-12	T4281	1-08	T5172	1-10
				T4322	1-08	T5181	1-10
				T4411	1-08	T51811	1-10
						T5331	1-10

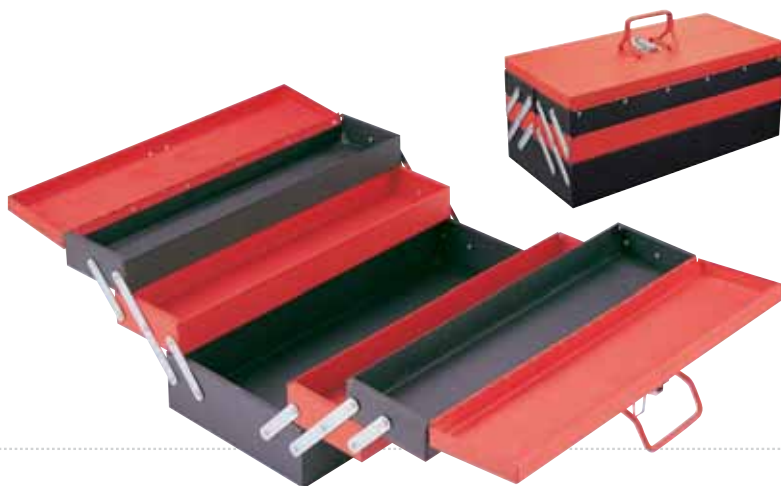

**50235**

L53.5 x W25.8 x H22.5 cm  
1pc / 8.2kg / 9.6kg / 2'

PROFESSIONAL TOOLS

**50223**

**50223R**

L70 x W47 x H34 cm  
1pc / 27.4kg / 29.3kg / 5.9'

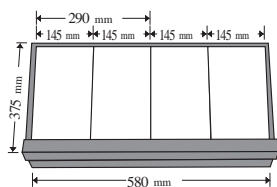

PROFESSIONAL TOOLS



**50225**

**50225R**

L69 x W46 x H49 cm  
1pc / 39.3kg / 42kg / 8.2'

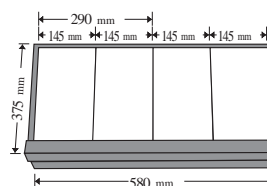

PROFESSIONAL TOOLS



**50217BC**

**50217C**

**50217RC**

L80 x W50 x H103 cm  
1pc / 75kg / 80kg / 16.9'

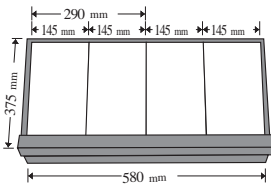

PROFESSIONAL TOOLS



**50218BC**

**50218C**

**50218RC**

L80 x W50 x H103 cm  
1pc / 75kg / 80kg / 16.9'

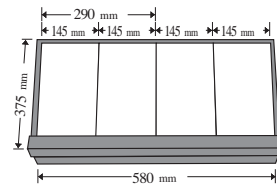

PROFESSIONAL TOOLS

**50318B**

**50318**

**50318R**

L95 x W50 x H103 cm  
1pc / 107kg / 117kg / 20.8'

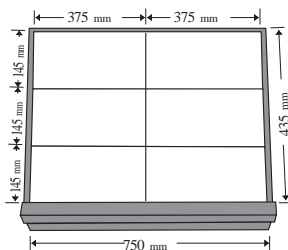

PROFESSIONAL TOOLS





**50253**

Heavy-duty workbench with drawers & fiberboard

1pc / 70.4kg / 77.8kg / 14.8'

With 10 pcs of 82023U 3" U-shaped hooks and 10 pcs of 82023S 3" single hooks.

With 3-drawer tool box 50223.

PROFESSIONAL TOOLS

**50254**

Heavy-duty workbench with drawers & lockable cabinet

1pc / 141kg / 148kg / 20'

With 10 pcs of 82023U 3" U-shaped hooks and 10 pcs of 82023S 3" single hooks.

With 3-drawer tool box 50223.



PROFESSIONAL TOOLS



**50234**

L45 x W33 x H15 cm

1pc / 12.9kg / 13.9kg / 1.5'



PROFESSIONAL TOOLS





**50235-101**

C5153 ; C5142 ; C21114 ; C4482 ; C5136

**50235-124(SAE&MM)**

C5203; C5142; C21114; C3661; C5136



PROFESSIONAL TOOLS



**50234-107**

Black suitcase with 107pcs of tools

PROFESSIONAL TOOLS

**50254-177**

**1st Drawer**

T2084B ; T2641 ; T3251-5 ; T4214

**2nd Drawer**

T5046 ; T5038 ; T5043A ; T5053

**3rd Drawer**

T5055 ; T5161 ; T5131 ; T5096

\* Tools in the cabinet are not included.

PROFESSIONAL TOOLS





**50217BC-286(MM)**

**50217C-286(MM)**

**50217RC-286(MM)**

PROFESSIONAL TOOLS

**1st Drawer**

T2084B ; T2085B ; T2086B ; T4413

**2nd Drawer**

T2641 ; T3251-72-5 ; T4212 ; T4057

**3rd Drawer**

T5161 ; T5052 ; T5111 ; T5082

**4th Drawer**

T5074 ; T5033 ; T5081 ; T5044

**5th Drawer**

T5053 ; T5038 ; T5046 ; T5131

**6th Drawer**

2095 ; 5106B

**50318B-437(MM)**

PROFESSIONAL TOOLS

**50318-437(MM)**

**50318R-437(MM)**

**1st Drawer**

T2742 ; T2046 ; 2137 ; 2142

**2nd Drawer**

PT5000 ; PT5000 ; T3311 ; T3381 ; T30712 ; T3331

**3rd Drawer**

T4203 ; T4116 ; T4248 ; T4119 ; T40612 ; T4322

**4th Drawer**

T5074 ; T5033 ; T5081 ; T5044 ; T5181 ; T5089

**5th Drawer**

5106B ; 2134 ; T5096 ; T5056

**6th Drawer**

T5043A ; T5131 ; T5046 ; T5053 ; T5038 ; T5055



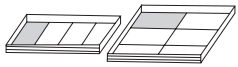

■ **T2045**

• 4pc Ratchet handle set



■ **T2046**

• 4pc Ratchet handle set



■ **T20712**

• 7pc Insulated screwdriver set

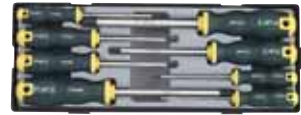

■ **T2084B**

• 8pc Screwdriver set



■ **T2084YC**

• 8pc Screwdriver set

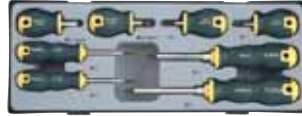

■ **T2085B**

• 8pc Screwdriver set



■ **T2085YC**

• 8pc Screwdriver set

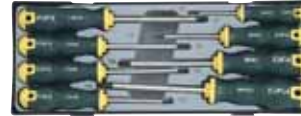

■ **T2086B**

• 8pc Star Screwdriver set



■ **T2086TB**

• 8pc Star tamperproof  
Screwdriver set



■ **T2086YC**

• 8pc Star Screwdriver set

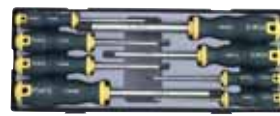

■ **T20810**

• 8pc Hex Screwdriver set



■ **T20810B**

• 8pc Hex ball point  
Screwdriver set



■ **T2641**

• 65pc Socket Combination  
set



■ **T2741**

• 74pc Socket Combination  
set



■ **T2742**

• 74pc Socket Combination  
set



■ **T2742-15**

• 74pc Socket Combination  
set



■ **T2742-18**

• 74pc Socket Combination  
set



■ **T30711**

• 7pc Ratchet handle set



■ **T30712**

• 7pc Ratchet handle set



■ **T3121**

• 12pc 6pt. Flank deep socket  
set



■ **T3193**

• 19pc 6pt. Flank socket  
set (SAE)



■ **T3212**

• 21pc Socket set (SAE)



■ **T3224**

• 22pc Universal Socket  
set



■ **T3251-5**

• 24pc Socket set



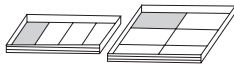

■ **T3251-5-18**

• 24pc Socket set



■ **T3251-72-5**

• 24pc Socket set



■ **T3311**

• 31pc Socket combination set



■ **T3322**

• 32pc Socket set (MM&SAE)



■ **T3322-15**

• 32pc Socket set (MM&SAE)



■ **T3322-23**

• 32pc Socket set (MM&SAE)



■ **T3322-24**

• 32pc Socket set (MM&SAE)



■ **T3331**

• 33pc 6pt. Flank & star socket set



■ **T3361**

• 36pc Socket Combination set



■ **T3381**

• 38pc Star & Spline set



■ **T3521**

• 52pc Star set



■ **T4057**

• 5pc Accessory set



■ **T4057-15**

• 5pc Accessory set



■ **T40612**

• 6pc Accessory set



■ **T40613**

• 5pc Accessory set



■ **T40613-23**

• 5pc Accessory set



■ **T4116**

• 11pc Mixed socket set



■ **T4119**

• 11pc 6pt. Flank impact deep socket set



■ **T4122**

• 12pc Socket bit set



■ **T4143**

• 14pc 6pt. Flank deep socket set



■ **T4193**

• 19pc 6pt. Flank impact socket set



■ **T4194**

• 19pc 6pt. Flank socket set (SAE)



■ **T4203**

• 20pc 6pt. Flank socket set



■ **T4212**

• 21pc 6pt. Flank socket set



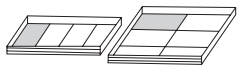

■ **T4214**

• 21pc Flank socket set



■ **T4248**

• 24pc 6pt. Flank socket set



■ **T4248S**

• 24pc 6pt. Flank socket set (SAE)



■ **T4281**

• 27pc Socket bit set



■ **T4322**

• 32pc 1/2" Star & Spline set

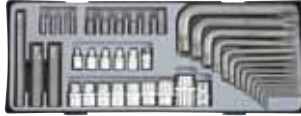

■ **T4411**

• 41pc Star set



■ **T4413**

• 41pc Star set



■ **T5021**

• 2pc Pliers set



■ **T5023**

• 2pc Adjustable wrench set



■ **T5033**

• 3pc Hinged socket wrench set



■ **T5034**

• 3pc Pliers set



■ **T5036**

• 3pc Adjustable wrench set



■ **T5036A**

• 3pc Adjustable wrench set



■ **T5038**

• 3pc Pliers set



■ **T5043A**

• 4pc Snap ring pliers set



■ **T5044**

• 4pc 75 Offset ring wrench set



■ **T5045**

• 4pc Pliers set



■ **T5046**

• 4pc Pliers set



■ **T5047**

• 4pc Pliers set



■ **T50410**

• 4pc Insulated pliers set



■ **T5052**

• 5pc Combination wrench set



■ **T5053**

• 5pc Hammer chisel set



■ **T5055**

• 5pc Cutting tools set



■ **T5056**

• 5pc File set

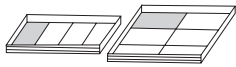

■ **T5057**

• 5pc Multi-grip pliers set



■ **T50616S**

• 6pc Hinged socket wrench set (SAE)



■ **T50617**

• 6pc 15 Offset star ratchet ring wrench set



■ **T50618-18**

• 6pc Spark plug combination set



■ **T50618-24**

• 6pc Spark plug combination set



■ **T50710**

• 7pc Flare nut wrench set (SAE)



■ **T5074**

• 7pc Hinged socket wrench set



■ **T5075**

• 7pc Hinged star socket wrench set



■ **T5079S**

• 4pc 75 Offset ring wrench set (SAE)



■ **T5081**

• 8pc 75 Offset ring wrench set (MM)



■ **T5082**

• 8pc Flare nut wrench set



■ **T5085**

• 8pc 45 Offset ring wrench set (MM)



■ **T5085S**

• 8pc 45 Offset ring wrench set (MM)



■ **T5089**

• 8pc Combination wrench set



■ **T50810**

• 8pc Ratchet ring wrench set



■ **T50811**

• 8pc 15 Offset ratchet ring wrench set (MM)



■ **T50812**

• 8pc Flat gear wrench set (SAE)



■ **T50813**

• 8pc Reversible gear wrench set (SAE)



■ **T50814**

• 8pc Mini pliers set



■ **T50817**

• 8pc Double ended 6pt.-6pt. socket wrench



■ **T5096**

• 9pc Measuring tools set



■ **T5111**

• 11pc Double open end wrench set



■ **T5111S**

• 11pc Double open end wrench set (SAE)



■ **T5114**

• 11pc Angle wrench set

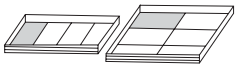

■ **T51210**

- 12pc Flat gear wrench set



■ **T51211**

- 12pc Reversible gear wrench set



■ **T51214**

- 12pc Midget combination wrench



■ **T51215**

- 12pc Flat gear wrench & holder set (SAE)



■ **T51215R**

- 12pc Reversible wrench & holder set (SAE)



■ **T5122**

- 12pc Auto kit set



■ **T5131**

- 13pc Chisel & punch set



■ **T5134**

- 13pc Combination wrench set (SAE)



■ **T5135S**

- 13pc Crowfoot flare nut wrench set (SAE)



■ **T5161**

- 16pc Combination wrench set



■ **T5164**

- 16pc Flat gear wrench & holder set



■ **T5164R**

- 16pc Reversible gear wrench & holder set



■ **T5172**

- 17pc Crowfoot flare nut wrench set (MM)



■ **T5181**

- 18pc Combination wrench set



■ **T51811**

- 181pc River pliers set



■ **T5331**

- 33pc Screw repair tools set

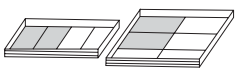

■ **2095**

- 9pc Hex nut driver T handle set



■ **2096**

- 9pc Star nut driver T handle set

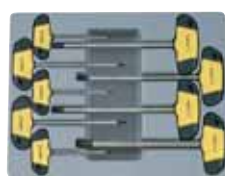

■ **2097**

- 9pc Hex screwdriver T handle set (MM)

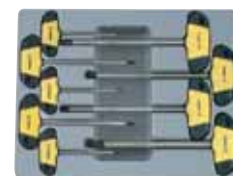

■ **2097B**

- 9pc Hex ball point screwdriver T handle set



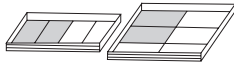

■ **2097S**

- 9pc Hex screwdriver T handle set (SAE)



■ **2108**

- 10pc Hammer screwdriver set



■ **2109**

- 10pc Hammer screwdriver set



■ **2125**

- 12pc Insulated screwdriver set



■ **2126**

- 12pc Insulated screwdriver set



■ **2134**

- 13pc Hex nut driver set



■ **2137**

- 13pc Star screwdriver set



■ **2137T**

- 13pc Star tamperproof screwdriver set



■ **2137YC**

- 13pc Star screwdriver set



■ **2141**

- 14pc Star screwdriver T handle set



■ **2141T**

- 14pc Star tamperproof screwdriver T handle set



■ **2142**

- 14pc screwdriver set



■ **2142YC**

- 14pc screwdriver set



■ **5048**

- 4pc terminal & stripper pliers set



■ **50713**

- 7pc Auto body repair tool set

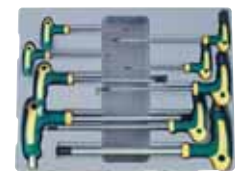

■ **50910BS**

- 9pc Hex ball point grip key set(SAE)



■ **50911**

- 9pc Half-moon ring wrench

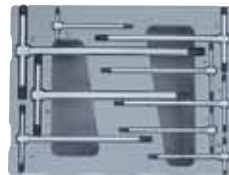

■ **50912**

- 9pc T shaped hex key



■ **54111**

- 411pc Tie tape pliers kits

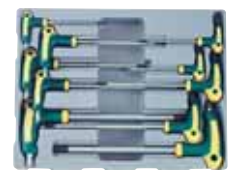

■ **51010T**

- 10pc Star tamperproof grip key set



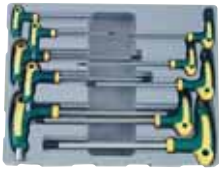
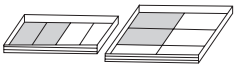

■ **5106B**

- 10pc Hex ball point grip key set



■ **5138**

- 13pc Quakeproof and safe punch set



■ **5139**

- 13pc Quakeproof chisel & punch set

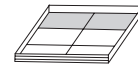

■ **50619**

- 6pc Wheel special tools kits set

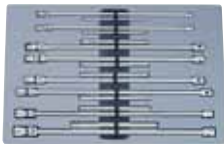
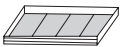

■ **50816**

- 8pc Universal long nut driver



■ **C4482**

- 48pc Socket combination set



■ **C21114**

- 11pc screwdriver set



■ **C3661**

- 66pc Combination set (S&M)



■ **C5136**

- 13pc Combination set



■ **C5142**

- 14pc Pliers and Hex key set



■ **C5153**

- 15pc Combination wrench set



■ **C5203**

- 20pc Combination wrench set(S&M)

■ **50131**

- Tool display stand  
1pc / 40kg / 43kg / 2.8'

- 82011 1-Display stand
- 82023U 12-3" U-shaped hook with screws
- 82026U 12-6" U-shaped hook with screws
- 82028U 12-8" U-shaped hook with screws



*For more information on FORCE trolleys, tool boxes, suitcases, workbenches and cabinets, please refer to the above catalogue.*



**2pc Torque adapter (spark plug special)**

<b>K3021</b>		
Part no.	24/12.0/13.0/0.8'	500g
832 318...324	Content: 3/8"DR. 2-Torque adapter 18Nm; 24Nm	



**3pc Step wrench set**

<b>4031</b>		
Part no.	20/17.0/18.0/1.4	850g
802412 68901	Content: 1/2"DR. 1- 1/2"DR. Square hole ratchet handle 1- Slotted step wrench 1.5x8.9 3/8"(9.35mm); 7/16"(9.75mm); 15/32"(12mm); 1/2"(12.8mm); 35/64"(13.8mm); 3/4"(18.4mm); 27/32"(21.4mm); 7/8"(21.9mm)	
68902	1- Hex step wrench 3/8"; 1/2"; 3/4"; 1"	



**2pc Pliers set**

<b>5021</b>		
Part no.	6/10.5/11.5/0.9'	1750g
613250 614250	Content: 1-Waterpump pliers 10" 1-Locking pliers 10"	





**2pc Adjustable wrench set**

<b>5023</b>		
Part no.	6/10.2/11.2/0.9'	1700g
649200B 649300B	Content: 2- Adjustable gauged wrench 8" (200mmL) 12" (300mmL)	





**3pc Pliers set**

<b>5034</b>		
Part no.	6/10.0/11.0/0.9'	1660g
610200	Content:	
611215	1- Long nose pliers 8"	
612175	1- Combination pliers 8.5"	
	1- Diagonal pliers 7"	





**3pc Adjustable wrench set**

<b>5036A</b>		
Part no.	6/12.2/13.2/0.9'	2040g
649200A	Content:	
649250A	3- Adjustable gauged wrench	
649300A	8" (200mmL)	
	10" (250mmL)	
	12" (300mmL)	





**3pc Adjustable wrench set**

<b>5036</b>		
Part no.	6/13.3/14.3/0.9'	2210g
649200	Content:	
649250	3- Adjustable gauged wrench	
649300	8" (200mmL)	
	10" (250mmL)	
	12" (300mmL)	





**3pc Pliers set**



<b>5038</b>		
Part no.	6/12.8/13.8/0.9'	2130g
649250B	Content:	
613B250	1- Adjustable wrench 10"	
614250	1- Waterpump pliers 10"	
	1- Locking pliers 10"	



**4pc Stud extractor set (MM)**



<b>5042</b>		
Part no.	20/16.5/17.5/0.82'	825g
818 06...12	Content: 4-Stud extractor 6; 8; 10; 12 mm	

**4pc Stud extractor set (SAE)**

<b>5042S</b>		
Part no.	20/16.5/17.5/0.82'	825g
818 1.4...7.16	Content: 4-Stud extractor 1/4"; 5/16"; 3/8"; 7/16"	





**4pc Pliers set**

<b>5045</b>		
Part no.	6/9.9/10.9/0.9'	1650g
610B200 611B175 612B175 673B215	Content: 1-Long nose pliers 8" 1-Combination pliers 7" 1-Diagonal pliers 7" 1-Slip joint pliers 8.5"	





**4pc Snap ring pliers set**

<b>5043A</b>		
Part no.	6/9.5/10.5.8/0.9'	1800g
609ASO 609ASC 609ABO 609ABC	Content: 4-Snap ring pliers External straight tip 1.8mm (open) Internal straight tip 1.8mm (close) External 90" bent tip 1.8mm (open) Internal 90" bent tip 1.8mm (close)	



**4pc Pliers set**

<b>5046</b>		
Part no.	6/9.9/10.9/0.9'	1650g
610B200 610B200B 611B175 612B175	Content: 1-Long nose pliers 8" 1-Bent long nose pliers 8" 1-Combination pliers 7" 1-Diagonal pliers 7"	





**4pc Pliers set**

**5047**



Part no.	6/11.8/12.8/0.9'	1970g
----------	------------------	-------

Content:	
5047P1	1-Long nose straight pliers 11"
5047P2	1-Long nose 45... pliers 11"
5047P3	1-Long nose 90... pliers 11"
5047P4	1-Multi-purpose 4 points gripping pliers 11"



**5pc Hammer chisel set**

**5053**



Part no.	6/14.5/16.5/0.9'	2415g
----------	------------------	-------

Content:	
616300	1- Enginer hammer 300g
616400	1- Rubber hammer 400g (280mmL)
3- Chisel	
60215180	15mm (180mmL)
60219180	19mm (180mmL)
60225220	25mm (220mmL)



**5pc Fill/Drain plug key set**

**5051**



Part no.	25/12.0/13.0/0.64'	480g
----------	--------------------	------

Content:	
5- Fill/Drain plug key	
5051-1	17mmHex - 14mmHex
5051-2	10mmHex - 12mmHex
5051-3	9mmHex - 5/16"Hex
5051-4	8mmSq. - 13mmSq.
5051-5	3/8" Sq. - 11mmSq.



**5pc Chisel punch set**

**5054**





Part no.	40/14.8/15.8/1.3'	370g
----------	-------------------	------

Content:	
60212150	1- Chisel 12mm (150mmL)
603150	1- Cape chisel (150mmL)
6044190	1- Pin punch 4mm (190mmL)
6063185	1- Taper punch 3mm (185mmL)
6074185	1- Center punch 4mm (185mmL)





**5pc Cutting tools set**

<b>5055</b>		
Part no.	6/9.5/10.5/0.9'	1583g
5055P1	Content:	
66302	1- Straight shears	
5055P3	1- Mini hacksaw frame 6"	
5055P4	2- Saw blade	
	1- Utility knife (include 3pc blades)	





**6pc Fill/Drain plug key set**

<b>5061</b>		
Part no.	25/17.5/18.5/0.64'	700g
	Content:	
	6- Fill/Drain plug key	
5061-1	5/16"Hex - 3/8"Hex	
5061-2	8mmSq. - 3/8"mmSq.	
5061-3	11mmSq. - 12mmHex	
5061-4	13mmSq. - 14mmHex	
5061-5	17mmHex - 1/2"Hex	
5061-6	8mmHex - 10mmHex	







**5pc File set**

<b>5056</b>		
Part no.	6/10.2/11.2/0.9'	1690g
	Content:	
5056P1	1- 8" Flat file	
5056P2	1- 8" Half round file	
5056P3	1- 8" Round file	
5056P4	1- 8" Square file	
5056P5	1- 8" Triangular file	





**6pc Impact driver set**



<b>5064</b>		
Part no.	20/19.0/20.0/0.62'	950g
	Content: 1/2" DR.	
8174	1- Impact driver	
	4- 5/16" Bit	
15136 2...3	Phillips PH.2; PH.3 (36mmL)	
15336 09...11	Slotted 9; 11 mm (36mmL)	
81045A	1- Impact bit holder 1/2"DR.x5/16"	

6pc Impact driver set		
<b>5064L</b>		
Part no.	20/19.0/20.0/0.62'	950g
8174	Content: 1/2" DR. 1- Impact driver 4- 5/16" Bit	
15180 2...3	Phillips PH.2; PH.3 (80mmL)	
15380 09...11	Slotted 9; 11 mm (80mmL)	
81045A	1- Impact bit holder 1/2"DR.x5/16"	





6pc Spring pin punch set		
<b>50614</b>		
Part no.	100/23.6/24.6/0.9'	236g
605 19090...79150	Content: 6- Spring pin punch 1.9mm (90mmL); 2.9mm (95mmL); 3.9mm (115mmL); 4.9mm (115mmL); 5.9mm (140mmL); 7.9mm (150mmL)	





6pc Brake spanner set		
<b>50612</b>		
Part no.	30/20.5/21.5/1.3'	680g
6080610	Content: 6- Brake spanner 1/4"Sq. - 10mmSq.	
6080608	1/4"Sq. - 5/16"OE	
6080810	8mmHex - 10mmHex	
6080911	9mmHex - 11mmHex	
6080607	1/4"Hex - 7mmHex	
6081109	7/16"OE - 11/32"Sq.	



7pc Stud extractor set (MM)		
<b>5078</b>		
Part no.	12/18.0/19.0/0.9'	1500g
818 05...14	Content: 7- Stud extractor 5; 6; 7; 8; 10; 12; 14 mm	



6pc Pin punch set		
<b>50613</b>		
Part no.	30/16.7/17.7/1.3'	540g
604 2140...8215	Content: 6- Pin punch 2mm (140mmL); 3mm (150mmL); 4mm (190mmL); 5mm (200mmL); 6mm (210mmL); 8mm (215mmL)	



**8pc Mini pliers set**

**50814**



Part no.	6/8.4/9.4/0.9'	1400g
----------	----------------	-------

	Content:
50814P1	1-Round nose pliers 5"
50814P2	1-Flat nose pliers 5"
50814P3	1-Combination pliers 5"
50814P4	1-Long nose pliers 5"
50814P5	1-Needle nose pliers 6"
50814P6	1-Bent nose pliers 6"
50814P7	1-Cutter pliers 6"
50814P8	1-Diagonal pliers 6"



**12pc Auto kit set**

**5122**



Part no.	6/13.0/14.0/0.9'	2160g
----------	------------------	-------

	Content:
	6-Fill/Drain plug key
5061-1	5/16"Hex - 3/8" Hex
5061-2	8mmSq. - 3/8" Sq.
5061-3	11mmSq. - 12mmHex
5061-4	13mmSq. - 14mmHex
5061-5	17mmHex - 1/2"Hex
5061-6	8mmHex - 10mmHex
8074	2-1/2"DR. Magnetic spark plug socket 16mm; 20.6mm
16M...20.6M	
810421	1-Plug key holder 1/2"(F)x21mm(F)
617	1-Telescope mirror stick/magnetic pick-up
618	1-20pc feeler gauges 0.05mm to 1mm
619	1-Oil filter strap wrench



**9pc Measuring tools set**

**5096**



Part no.	6/10.0/11.0/0.9'	1666g
----------	------------------	-------

	Content:
5096P1	1-Stainless steel vernier caliper
5096P2	1-Auto center punch
5096P3	1-Stainless steel straight rule 30cm
5096P4	1-Stainless steel protractor
5096P5	1-Screw pitch gauges 0.25-6 (MM)
5096P6	1-Screw pitch gauges 4-62 (SAE)
61802	1-26 sizes Feeler gauges (SAE & MM)
5096P7	1-Steel scriber
5096P8	1-5m measuring tape





**13pc Chisel & punch set**

**5131**



Part no.	6/13.0/14.0/0.9'	2167g
----------	------------------	-------

602	Content:
10150...22200	5- Chisel 10 (150mmL); 12 (150mmL); 15 (180mmL); 19 (200mmL); 22 (200mmL)
603150	1- Cape chisel 150mmL
604 2140...4190	3- Pin punch 2 (140mmL); 3 (150mmL); 4 (190mm)
606 2185...4185	3- Taper punch 2 (185mmL); 3 (185mmL); 4 (185mmL)
6074185	1- Center punch 4 (185mmL)



**17pc Impact driver set**

**5171**



Part no.	20/22.0/23.0/0.82'	1100g
----------	--------------------	-------

8174	Content: 1/2" DR. 1- Impact driver 14- 5/16" bit
15136 2...3	Phillips PH.2; PH.3 (36mmL)
15236 2...3	Pozidriv PZ.2; PZ.3 (36mmL)
15336 09...11	Slotted 9; 11 mm (36mmL)
15635 25...50	Star T25; T30; T40; T45; T50 (35mmL)
15436 06...10	Hex 6; 8; 10 mm (36mmL)
81045A	1- Impact bit holder 1/2"DR.x5/16"
8095330	1- Bit adaptor 5/16"Hex-3/8" Sq.



**20pc Star screw measure set**

<b>5201</b>		
Part no.	60/4.0/5.0/2.6'	66g

Help select the correct Torx sizes of bit or socket

Content:

20-Star screw measure

- E1xT5; E2xT6; E4xT7; E5xT8;
- E6xT9; E7xT10; E8xT15;
- E10xT20; E11xT25; E12xT27;
- E14xT30; E16xT35; E18xT40;
- E20xT45; E22xT47; E24xT50;
- E26xT55; E28xT60; E30xT70;
- E32xT80



**1/4\"/>**

<b>601235</b>		
Part no.	250/7.0/8.0/1.3'	28g

1/4" Driver tamperproof mixture adjuster (Double D) for use on Asian and Mikuni carburetors found on Toyota and Mitsubishi cars (35mmL)



**1/4\"/>**

<b>601250</b>		
Part no.	250/7.0/8.0/1.3'	28g

1/4" Driver tamperproof mixture adjuster (Fish Tail) for use on Nikki and Hitachi carburetors found on Nissan and Subaru cars (50mmL)



**Piston ring compressor**

<b>62001</b>		
Part no.	8/12.2/13.2/1.8'	3125g

- \* Install pistons from 2-7/8" to 4-3/8" (73-111mm)
- \* Ratcheting lock allows the bands to compress in small increments.
- \* Can be used parallel vertically perpendicular horizontally.
- \* Set includes pliers and 6 bands.
- \* Contents :
  - 1pc Ratchet pliers
  - 1pc Band size 2-7/8" to 3-1/8"
  - 1pc Band size 3-1/8" to 3-3/8"
  - 1pc Band size 3-3/8" to 3-5/8"
  - 1pc Band size 3-5/8" to 3-7/8"
  - 1pc Band size 3-7/8" to 4-1/8"
  - 1pc Band size 4-1/8" to 4-3/8"

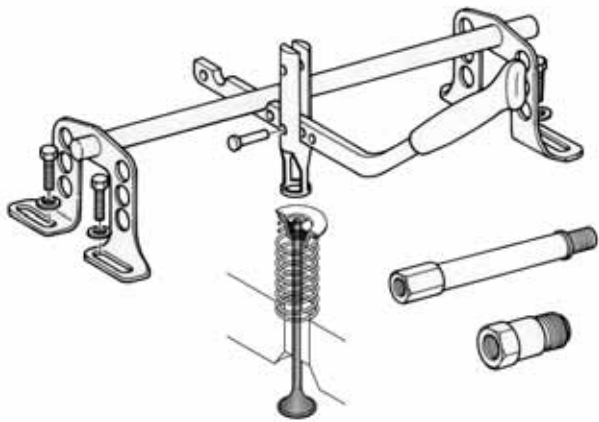

**Valve spring compressor**

<b>62105</b>		
Part no.	5/19.0/20.0/2'	3800g

Universal overhead cam Applying for most popular cars engines, including AUDI, CHRYSLER, INFINITI, HONDA, HYUNDAI, LEXUS, MAZDA, MITSUBISHI, NISSAN, PORSCHE, SATURN, TOYOTA, VOLVO and VOLKSWAGEN.



**Universal strut spring compressor**

<b>62702</b>		
Part no.	2/18.7/19.7/1.5'	9350g

- \* This tool fits a wide range of struts without the inconvenience of special adaptor shoes.
- \* Tool compresses springs of 4" to 8" OD. with wire diameters of 7/16" to 11/16". Works both by hand or impact wrench.
- \* The jaws of the compressor are held in place by safety locking pins.
- \* Use most of spring compressor quickly and easily on the bench or on the vehicle.



**5pc Screw extractor set**



<b>63005</b>		
Part no.	100/13.4/14.4/1.4'	134g

Content:  
7/64"; 9/64"; 5/32"; 1/4"; 19/64"





**8pc Screw extractor set**

<b>63006&amp;63006B</b>		
Part no.	24/19.9/20.9/0.79'	830g
63006	5/64"; 7/64"; 5/32"; 1/4"; 19/64"; 13/32"; 17/32"; 13/16"	
63006B	5/64"; 7/64"; 5/32"; 1/4"; 19/64"; 13/32"; 17/32"; 13/16"(CR-MO)	



**5pc Spark plug rethreader set**

<b>64101</b>		
Part no.	72/12.0/13.0/0.75'	166g



Content:

- 1pc 14mm Spark plug rethreader
- 4pc inserts 3/8"; 7/16"; 1/2"; 3/4" long

- \* Repairing stripped or damaged threads in aluminum cylinder heads.
- \* Solid steel inserts replace damaged threads.





**11pc Torque wrench set**

<b>64701L</b>		
Part no.	12/20.4/21.4/0.85'	1700g
6473380	Content: 3/8" DR.	
535 10...21	1- 3/8"DR. Lock torque wrench	
334050 04...08	6- 3/8"DR. 6pt. Flank socket 10; 12; 14; 17; 19; 21mm	
	4- 3/8"DR. Hex socket bit 4; 5; 6; 8mm (50mmL)	





**11pc Torque wrench set**

<b>64702L</b>		
Part no.	12/20.4/21.4/0.85'	1700g
6474535	Content: 1/2" DR.	
545 17...27	1- 1/2"DR. Lock torque wrench	
344055 06...12	6- 1/2"DR. 6pt. Flank socket 17; 19; 21; 22; 24; 27 mm	
	4- 1/2"DR. Hex socket bit 6; 8; 10; 12 mm (50mmL)	



**2pc Torque driver set**

<b>64703</b>		
Part no.	40/15.2/16.2/0.5'	380g
6472150	Content: 1/4" DR.	
81022	1- 1/4"DR. Torque driver	
	1- Bit holder 1/4"(F)x1/4" inhex	



**8pc Head-interchangeable torque wrench & spanner set**

<b>64704</b>		
Part no.	6/19.5/20.5/1.2'	3250g
647B110	Content:	
647H4	1- 19~110Nm Torque wrench	
685 17...29	1- 1/2"DR. Ratchet head	
	6- Spanner head	
	17; 22; 24; 26; 27; 29 mm	



**11pc Head-interchangeable torque wrench & spanner set**

<b>64705</b>		
Part no.	4/17.9/18.9/0.96'	4470g
647B200	Content:	
647H4	1- 40~200Nm Torque wrench	
685 13...30	1- 1/2"DR. Ratchet head	
	9- Spanner head	
	13; 14; 15; 17; 19; 22; 24; 27; 30 mm	



**47pc Torque driver set**

<b>K64706</b>		
Part no.	24/21.7/22.7/1.5'	905g
6472150	Content: 1/4"DR.	
81022	1-Torque driver	
8042100	1-Bit holder 1/4"(F)x1/4"inhex	
12125 0...3	1-Extension 4"	
12223 0...3	4-Phillips bit (25mmL)	
12325 03...065	PH.0; PH.1; PH.2; PH.3	
12425 015...06	4- Pozidriv bit (25mmL)	
124R25 1...3	PZ.0; PZ.1; PZ.2; PZ.3	
12625 06...40	5-Slotted bit	
12725 06...40	3; 4; 5; 5.5; 6.5 mm	
	6-Hex bit	
	1.5; 2; 3; 4; 5; 6 mm	
	3-Square bit	
	1; 2; 3 mm	
	11-Star bit	
	T6; T7; T8; T9; T10; T15;T20;	
	T25; T27; T30; T40	
	11-Star tamperproof bit	
	T-6H; T-7H; T-8H; T-9H; T-10H;	
	T-15H;T-20H; T-25H; T-27H;	
	T-30H; T-40H	

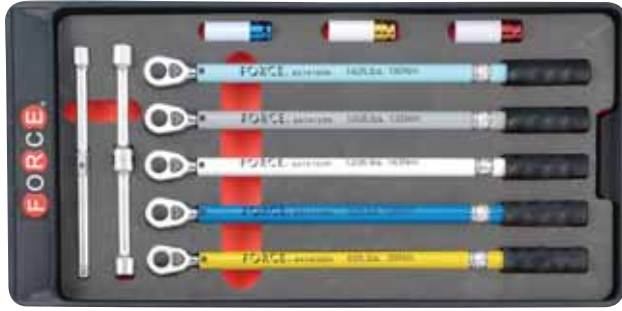

**9pc Wheel specialized torque tool set**

**64707**



Part no.	1/12.4/13.4/0.85'	12.4kg
----------	-------------------	--------

6474 088N...190N	Content: 1/2" DR. 5- Torque wrench 88; 108; 135; 163; 190 Nm	
44585 17C...21C	3- Wheel nut 6pt. flank impact socket (85mmL) 17; 19; 21 mm	
681A300	1- Assembly wheel nut wrench 17; 19; 13/16"; 1/2"DR. (300mmL)	



**Tubing cutter and double flaring tools kit (Metric)**

**656M**



Part no.	10/17.2/18.2/1'	1720g
----------	-----------------	-------

Content:  
1pc Tubing cutter.  
1pc 9/16" Screen bar.  
7pc Adaptor 4; 6; 8; 10; 12; 14; 16 mm



**Tubing cutter and double flaring tools kit**

**656**



Part no.	10/18.0/19.0/1.8'	1800g
----------	-------------------	-------

Content:  
\*Tubing cutter.  
\*9/16" Screen bar.  
\*7pc Adaptor 3/16"; 1/4"; 5/16"; 3/8"; 7/16"; 1/2"; 5/8"



**Brake caliper piston tools**

**658**



Part no.	12/17.0/18.0/1.3'	1416g
----------	-------------------	-------

\* Application: FORD, ROVER, HONDA, MERCEDES, TOYOTA, VW, AUDI, NISSAN, BMW, MAZDA, MITSUBISHI, PEUGEOT, SUBARU  
\* Kit comprises main body, screw assembly, special locating plate and 5 adaptors covering wind-back.





**Slide hammer puller set**

<b>664</b>		
Part no.	2/13.0/14.0/1.6'	6500g

Content:

- 1pc T bar
- 1pc Hammer (5 lbs.)
- 1pc High axle puller
- 1pc Low axle puller
- 1pc Grip wrench adaptor
- 1pc Nut
- 1pc 2 Jaw head
- 1pc 3 Jaw head
- 3pc Screw & nut
- 1pc Attachment
- 3pc Jaw
- 1pc Tapping screw
- 1pc Hook



**Slide hammer puller set**

<b>664A</b>		
Part no.	2/19.0/20.0/2.1'	9488g

Slide hammer puller set has several pulling attachments to give the user various methods for pulling, maintenance and repair applications; the slide hammer exerts force when needed.

<b>664A</b>		
Part no.	2/19.0/20.0/2.1'	9488g

Content:

- 9pc Adjustable reversible jaw
- 1pc Forcing screw
- 1pc Two-way yoke
- 1pc Three-way yoke
- 1pc Reversible adjusting nut
- 3pc Screw & nut
- 1pc Handle rod
- 1pc Hammer (5 lbs.)
- 1pc High axle puller
- 1pc Low axle puller
- 1pc Inside hook jaw
- 1pc Pivot pin
- 1pc Hexagon screw
- 1pc Attachment
- 1pc Tapping screw
- 1pc Nut



**Locking jaw puller set**

<b>664P</b>		
Part no.	6/13.5/14.5/1.33'	2250g

The set has several pulling attachments to give the user various methods for pulling, maintenance and repair applications.

Content:

- 9pc Adjustable reversible jaw
- 1pc Forcing screw
- 1pc Two-way yoke
- 1pc Three-way yoke
- 1pc Reversible adjusting nut
- 3pc Screw & nut

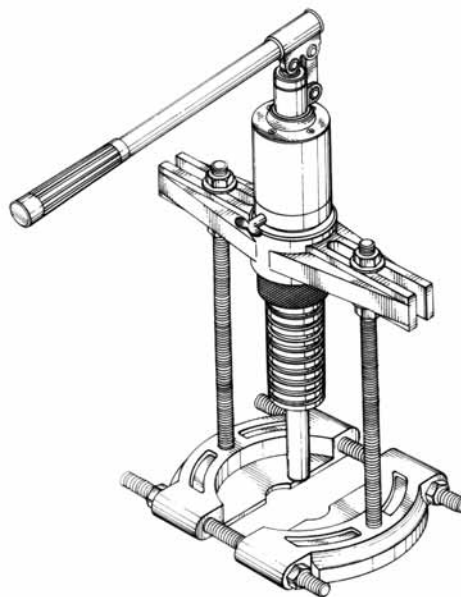

**Hydraulic bearing separator puller set**

666..					
Part no.	Capacity	Reach(mm)	Spread(mm)	Stroke	kg
66605	6 tons	300/190	235/210	82	16
66606	8 tons	300/245	235/220	82	17
66607	10 tons	330/220	235/210	82	16
66608	12 tons	330/275	235/220	82	17



**10LBS 9pc Dent puller set**

**665B**



Part no.

2/16.8/17.8/0.9'

8420g

Content:

- 1pc Pipe (Diameter 22.5mm x 590mmL)
- 1pc Pipe (Diameter 22.5mm x 200mmL)
- 1pc 2 Hole pipe (Diameter 29mm x 40mmL)
- 1pc Hammer (10lbs.)
- 1pc Plate (6mm x 170mm) / 1pc Plate (6mm x 120mm)
- 1pc Plate (6mm x 120mm) / 1pc Plate (6mm x 200mm)
- 1pc Plate (3mm x 100mm)
- 1pc Chain & hook
- 1pc Hex nut (29mm)



**Pressure screw separator puller set**

**66602**



Part no.

2/15.0/16.0/1'

7.5kg

Content:

- 1pc Central bolt
- 1set Bearing separator & bolts, SCM415, capacity 75-105mm
- 2pc Main rod (8"x1.75p)
- 2pc Extension rod (8"x1.75p)
- 1pc Beam
- 1pc Nut



**Hydraulic bearing separator puller set**

**66601**



Part no.

2/17.0/18.0/0.51'

8.5kg

Content:

- 1pc Hydraulic ram (SCM415 Diameter 37.7mm x 160mmL x 16t)
- 1set Bearing separator & bolts, SCM415, capacity 75-105mm
- 2pc Main rod (8"x1.75p)
- 2pc Extension rod (8"x1.75p)
- 1pc Beam



**Bearing race and seal driver set**

**66603**



Part no.

12/20.6/21.6/1.9'

1790g

Makes it easier to insert wheel bearing race and seals without damage to race and axle housing. The set includes 9 disc sizes to fit most standard wheel bearing. Turn discs over to drive seals.





**Differential side bearing puller**

**666A01**



Part no.	10/21.0/22.0/1.46'	2100g
----------	--------------------	-------

- \* Use to remove differential side carrier bearing. Works on a wide variety of cars and light-duty trucks.
- \* Includes four step plate adapters to fit carrier bearings.



**A/C Clutch puller set**

**666A02**



Part no.	10/22.0/23.0/1.46'	2200g
----------	--------------------	-------

- \* Versatile 2-jaw puller designed to remove stubborn A/C clutch pulleys.
- \* Features two sets of jaws, a crossbar with three settings for correct spread, and an adjustable yoke to keep jaws tight.
- \* Spread of jaws: 3" to 5". Reach of jaws: 1" to 2-1/4".



**21pc Go-through ratchet socket set (SAE&MM)**

**666A03**



Part no.	5/21.8/22.4/1.3'	4360g
----------	------------------	-------

- \* For a wide range of pulling jobs, including: bearings, alternators, generators, power steering and crankshaft pulleys, timing gears, and harmonic balancers.
- \* Spread: 2-3/8" to 3-3/8" & 3-1/2" to 5-1/2"
- \* Reach: 1-5/8" & 1-3/4"
- \* Set includes drop-forged components, which can be used in a variety of combinations.



**Axle spindle rethreading set**

**67001**



Part no.	36/21.0/22.0/1.8'	583g
----------	-------------------	------

- 8pcs thread restoring die set is used to clean or repair axle threads on spindles.
- Use with 1-1/4" socket or wrench.
- Size: M24x1.50; M24x2.00; M22x1.00; M22x1.50; M20x1.50; M20x1.25; 3/4"x20UNEF; 13/16"x20UNEF

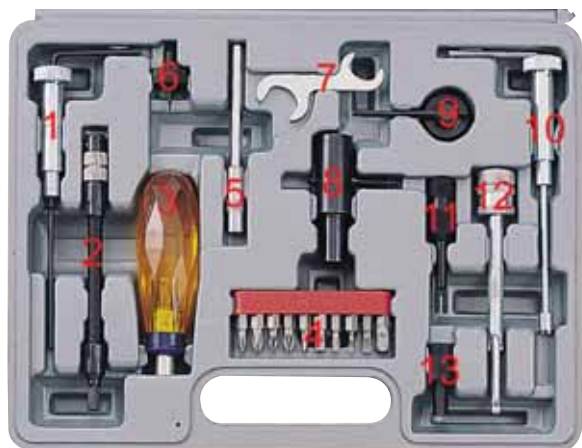

**Fuel system tool set**

**67101**



Part no.	12/13.0/14.0/1.2'	1330g
----------	-------------------	-------

General application

Content:

1. 3mm Hex - ZENITH (STROMBERG) 150 CD3, JAGUAR, LOTUS, MG, LAND ROVER, RANGE ROVER and SAAB.
2. 145mm Flexible extension
3. Handle
4. Bit set - T20 : FORD W CARBS, Fuel pumps etc.
  - 3mm Hex : " K " Jetronic.
  - 5mm Hex : " L " Jetronic.
  - Slotted 3; 5mm
  - Phillips PH.1; PH.2
  - Pozidriv PZ.1; PZ.2
  - Bit adaptor 1/4"Hex-1/4" Sq.
5. 95mm extension
6. FORD - WEBER TLDM, DFTM, 2V, TLM, TLD, DFT etc.FORD FIESTA, ESCORT and ORION 1989.
7. 17mm(0.6") - SU/SU HIF ROVER MINI and METRO.
8. 0.34", 1/2" - SU/SU HIF ROVER MINI and METRO.
9. ZENITH CD, OPEL/VAUXHALL
10. ZENITH (STROMBERG) CD, LAND ROVER, SAAB, VAUXHALL and VOLVO
11. NIKKI, HITACHI, NISSAN and SUBARU.
12. ZENITH
13. AISAN and MIKUNI, TOYOTA and MITSUBISHI.



**4pc Nut splitter set**

**672**



Part no.	12/17.5/18.5/0.95'	1250g
----------	--------------------	-------

6720912	1pc 5/16"to 1/2" (9-12mm)
6721216	1pc 1/2" to 5/8" (12-16mm)
6721622	1pc 5/8" to 7/8" (16-22mm)
6722227	1pc 7/8" to 1-1/8" (22-27mm)



**2pc M10 Alternator tools**

**674**



Part no.	100/21.2/22.2/1.5'	110mm	212g
----------	--------------------	-------	------

- \* 1pc 1/2"DR. Spline (XZN) socket bit M10x110mmL
- \* 1pc Reaction corkscrew cap  
33 teeth-fl19mm-17mm hex
- \* Application : VW-Audi, Škoda, Porsche, BMW, Ford, Mercedes-Benz etc.



**2pc T50 Alternator tools**

**678**



Part no.	100/21.2/22.2/1.5'	110mm	212g
----------	--------------------	-------	------

- \* 1pc 1/2"DR. Torx socket bit T50x110mmL
- \* 1pc Reaction corkscrew cap  
33 teeth-fl19mm-17mm hex
- \* Application: Mercedes A Class.

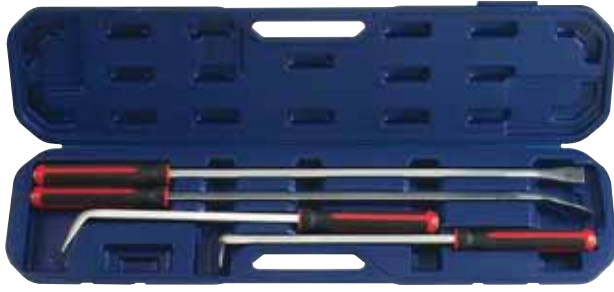

**4pc Jumbo heavy duty pry bar set**

<b>904U2</b>		
Part no.	2/17.5/18.5/1.4'	8730g

- \* Extra large handles allow use of both hands for increased leverage
- \* Textured handle grips for secure hold
- \* Chrome Molybdenum steel shafts
- \* Hardened and tempered for maximum strength
- \* Heavy duty 5/8" bar stock
- \* Go-thru shafts with steel end caps
- \* Sizes : 24" x 45B; 24" x 90B; 36" x 45B; 36" straight



**6pc Chisel & punch set  
(long type, interchangeable)**

<b>906U1</b>		
Part no.	36/25.5/26.5/2.2'	710g

**Contents:**

- 1pc Main handle
- 1pc Flat chisel 13mm
- 1pc Center punch 3mm
- 3pc Pin punch 3; 4; 5mm
- \* Material and shape: Main handle made by carbon steel; Bits made by Chrome-Vanadium. All shank 10mm hex with two grooves.
- \* Comfortable and protective handle
- \* Double locking device holding tight
- \* Save space, time and money
- \* Create high efficiency
- \* **WARNING:** Wear safety goggles when in use; Chisel and punch shanks have to be inserted to hole bottom.



**10pc Impact socket set (3/8" DR.)**

<b>910U2</b>		
Part no.	28/18.9/19.9/1.8'	675g

**Contents:**

- 9pc impact socket : mm(inches)  
10; 11; 12; 13; 14; 15; 16(5/8"); 17; 19(3/4")
- 1pc 8mm Straight rod

**Features:**

1. This impact socket set is a tool and it is specially designed for loosening a nut which can not be done by a socket or wrench.
2. This tool is only useful for a nut with positive threads.
3. This tool can also be used while a nut could not be loosened in a normal way because of rust and deformation.
4. This socket set is made of AISI4340 with HRC52-55 hardness.

**Instruction:**

1. Choose an appropriate socket then hit it by a hammer into a nut to be loosened.
2. Use a manual wrench to loosen the nut in anticlockwise.
3. Use a straight rod to push the end of nut stayed in the socket.

**!! Notes:**

While operation, be sure to wear glasses to protect eyes from nut fragment.



**10pc Universal locking tool set**

**910U3**



Part no.

10/13.1/14.1/1.3'

1310g

- \* The multipurpose 9-1/2" pliers has five attachments.
- \* Parts are interchangeable depending on the desired functions and purpose.



**Piston ring service tool set**

**911G3**



Part no.

6/15.5/16.5/2.8'

2583g

- \* Piston ring compressor w/ratchet key  
H:3"(53-125mm), H:3-1/2"(90-175mm),  
H:4"(90-175mm)
- \* Piston ring tool capacity: 50-100mm
- \* Piston ring groove cleaning  
Fits: 2"-5"(51 to 127mm)  
Blade 1 size: 1/16" to 3/16"  
Blade 2 size: 2.0mm to 4.5mm, 1/4"  
Blade 3 size: 1.2mm to 5.5mm
- \* Offset screwdrivers: ⊕ ⊙



**11pc Auto body repair set  
(Interchangeable)**

**911M1**



Part no.

10/23.0/24.5/1.8'

2300g

**Contents:**

- 1pc Head-interchangeable hammer
- 1pc Multi Dolly
- 1pc Cross curve
- 1pc Ball peen
- 1pc Ball type
- 1pc End small curve
- 1pc Angel groove
- 1pc Round face
- 1pc Square face
- 1pc Multi curve

- \* Material: Main hammer made from drop forged tool steel; All bits made from Chrome-Vanadium
- \* Double locking device holding tight
- \* Save space/weight
- \* Save money/time
- \* Create high efficiency
- \* Warning: Form hitter bits shank has to insert to hole's bottom.





**12pc Internal-external circlip pliers set**

<b>912U1</b>		
Part no.	6/19.8/20.8/2.3'	3300g

- \* Feature replaceable points and spring ratchet locking mechanism to securely hold against circlip tension.
- Internal: 3-1/16" - 6-1/4"
- External: 3-1/2" - 6-1/2"
- \* Tip Diameter: 0.12" (3mm)
- Spread: 3-1/4" (85mm)
- Length: 16" (400mm)



**12pc Chisel & punch set (interchangeable)**

<b>912U2</b>		
Part no.	20/24.0/25.5/2.4'	1200g

- Contents:
- 1pc Main handle
  - 2pc Flat chisel 10; 13mm (width of blade)
  - 1pc Cape chisel 4mm (width of blade)
  - 3pc Taper punch 2; 3; 4 mm
  - 3pc Pin punch 3; 4; 5 mm
  - 2pc Center punch 0; 3 mm
- \* **WARNING:** Wear safety goggles when in use; Chisel and punch shanks have to be inserted to hole bottom.

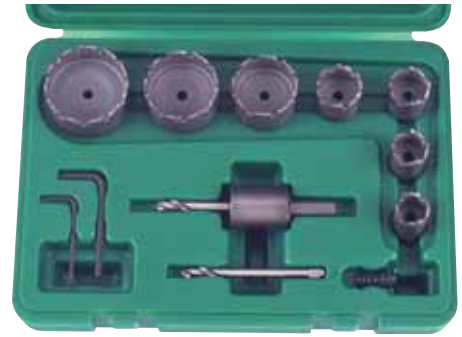

**13pc Tungsten carbide tipped metal borer set**

<b>913U1</b>		
Part no.	10/15.7/16.7/1.4'	1570g

- \* Use the same arbor for saw heads of different sizes.
- \* Change saw heads with a simple push and turn the fixed screw.
- \* H.S.S. center drill is replaceable.
- \* Shank size of the arbor is 3/8".
- \* Spring can help slug removal.

- Content:
- 7pc Saw head  
19; 22; 25; 28; 30; 32; 35 mm
  - 1pc Arbor
  - 1pc Spring
  - 2pc H.S.S center pilot drill 75; 84 mm
  - 2pc Hex key 2.5; 4.0 mm



**13pc Tungsten carbide tipped metal borer set**

<b>913U2</b>		
Part no.	10/15.7/16.7/1.4'	1570g

- \* Use the same arbor for saw heads of different sizes.
- \* Change saw heads with a simple push and turn the fixed screw.
- \* H.S.S. center drill is replaceable.
- \* Shank size of the arbor is 3/8".
- \* Spring can help slug removal.

- Content:
- 7pc Saw head  
30; 32; 35; 38; 40; 45; 51 mm
  - 1pc Arbor
  - 1pc Spring
  - 2pc H.S.S center pilot drill 75; 84 mm
  - 2pc Hex key 2.5; 4.0 mm



**15pc Chisel & punch set  
(interchangeable)**

**915U3**



Part no.

10/22.5/23.5/1.8'

2250g

**CONTENTS:**

- 1pc Main handle
- 5pc Flat chisel 13; 16; 19; 22; 25 mm (width of blade)
- 1pc Cape chisel 6mm (width of blade)
- 2pc Taper punch 3; 6 mm
- 2pc Pin punch 5; 6 mm
- 1pc Center punch 5 mm
- 1pc Point chisel
- 1pc Flat blade 60mm
- 1pc Curve blade 40mm
- \* Material and shape: Main handle made from Chrome-Molybdenum; Bits made by Chrome-Vanadium. All shank 13mm hex with two grooves.
- \* Comfortable and protective handle
- \* Double locking device holding tight
- \* Save weight, space, time and money
- \* Create high efficiency

**WARNING:** Wear safety goggles when in use; Chisel and punch shanks have to be inserted to hole bottom.



**15pc Hammer chisel & punch set  
(interchangeable)**

**915U4**



Part no.

10/24.0/25.5/2.4'

2400g

**CONTENTS:**

- 1pc Head-interchangeable hammer
- 5pc Flat chisel 13; 16; 19; 22; 25 mm
- 1pc Cape chisel 6mm
- 2pc Taper punch 3; 6 mm
- 2pc Pin punch 5; 6 mm
- 1pc Center punch 5 mm
- 1pc Flat blade 60mm
- 1pc Curve blade 40mm
- 1pc Point chisel
- \* Material: Main hammer made from drop forged carbon steel; Bits made by Chrome-Vanadium.
- \* Safe and comfortable handle of hammer.
- \* Double locking device holding tight
- \* Save weight, space, time and money
- \* Create high efficiency

**WARNING:** Wear safety goggles when in use; Chisel and punch shanks have to be inserted to hole bottom.



**Chisel**

<b>602</b>				
Part no.	size	<i>l</i> mm	 g	 pc/box
60210150	10	150	83	10
60212150	12	150	89	10
60215180	15	180	152	10
60219200	19	200	293	10
60222200	22	200	302	5
60225220	25	220	415	5



**Quakeproof and safe chisel**

<b>602...Q</b>				
Part no.	size	<i>l</i> mm	 g	 pc/box
60210150Q	10	150	100	10
60212150Q	12	150	102	10
60215180Q	15	180	168	10
60219200Q	19	200	320	5
60222200Q	22	200	327	5
60225220Q	25	220	440	5



**Cape chisel**

<b>603</b>				
Part no.	size	<i>l</i> mm	 g	 pc/box
603150		150	83	10



**Quakeproof and safe cape chisel**

<b>603...Q</b>				
Part no.	size	<i>l</i> mm	 g	 pc/box
603150Q		150	100	10



**Pin punch**

<b>604</b>				
Part no.	size	<i>l</i> mm	 g	 pc/box
6042140	2	140	42	10
6043150	3	150	45	10
6044190	4	190	86	10
6045200	5	200	91	10
6046210	6	210	133	10
6048215	8	215	150	10
60410230	10	230	218	10
60412280	12	280	349	10
60414290	14	290	464	10
60416310	16	310	544	10



**Quakeproof and safe pin punch**

<b>604...Q</b>				
Part no.	size	<i>l</i> mm	 g	 pc/box
6042140Q	2	140	58	10
6043150Q	3	150	59	10
6044190Q	4	190	105	10
6045200Q	5	200	106	10
6046210Q	6	210	147	10
6048215Q	8	215	166	10
60410230Q	10	230	235	10
60412280Q	12	280	381	5
60414290Q	14	290	495	5
60416310Q	16	310	575	5





**Spring pin punch**

<b>605</b>				
Part no.	size	<i>l</i> mm	 g	 pc/box
60519090	1.9	90	18	10
60529095	2.9	95	18	10
60539115	3.9	115	33	10
60549115	4.9	115	35	10
60559140	5.9	140	56	10
60579150	7.9	150	74	10





**Taper punch**

<b>606</b>		<i>l</i>		
Part no.	size	mm	g	pc/box
6062185	2	185	95	10
6063185	3	185	96	10
6064185	4	185	98	10
6065185	5	185	101	10
6066185	6	185	103	10
6068185	8	185	149	10





**Quakeproof and safe center punch**

<b>607...Q</b>		<i>l</i>		
Part no.	size	mm	g	pc/box
60725185Q	2.5	185	114	10
6074185Q	4	185	116	10
6076185Q	6	185	120	10
6078185Q	8	185	166	10
60710185Q	10	185	219	10



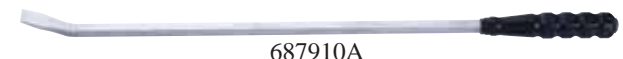

**Quakeproof and safe taper punch**

<b>606...Q</b>		<i>l</i>		
Part no.	size	mm	g	pc/box
6062185Q	2	185	114	10
6063185Q	3	185	115	10
6064185Q	4	185	116	10
6065185Q	5	185	119	10
6066185Q	6	185	120	10
6068185Q	8	185	166	10





**Jumbo pry bar**

<b>687..</b>	<i>l</i>		
Part no.	Length	g	packing
687780	780mm-30.7"	1085	20/21.7/22.7/0.9'
687910	910mm-36"	1830	12/22.0/23.0/1'
687910A	910mm-36"	1830	12/22.0/23.0/1'





**Center punch**

<b>607</b>		<i>l</i>		
Part no.	size	mm	g	pc/box
60725185	2.5	185	95	10
6074185	4	185	97	10
6076185	6	185	103	10
6078185	8	185	147	10
60710185	10	185	203	10







**Rubber hammer**

<b>616</b>		<i>l</i>	
Part no.	packing	mm	g
616260	72/25.0/27.0/1.71'	262	350
616400	48/26.0/28.0/1.62'	280	520
616580	36/25.0/27.0/1.61'	300	690
616810	24/23.0/25.0/1.35'	320	940



**Engineer hammer**

<b>616...</b>		
Part no.	packing	g
616300	48/20.7/22.2/1.11'	431
616500	36/22.0/23.5/1.19'	611
6161000	16/20.0/21.3/0.91'	1250
6161500	12/21.0/22.1/0.84'	1750



**Utility knife**

<b>5055P4</b>		<i>l</i>	
Part no.		165mm	168g

\* Blade available



**Super heavy duty hacksaw**

<b>66301</b>		
Part no.	24/22.0/23.0/1.9'	916g

- \* Grip handle design
- \* Quick-change blade design
- \* Blade available





**Mini hacksaw**

<b>66302</b>		
Part no.	72/15.7/16.7/1'	218g

- \* Ergonomic grip handle design.
- \* For plastic, wood or metal.
- \* Blade length 150mm, overlength 270mm.
- \* Blade available



**Hacksaw**

<b>66303</b>	<i>l</i>		
Part no.	135mm	72/15.7/16.7/1'	100g

\* Blade available



**Technician's scissors**

<b>6982</b>		<i>l</i>	
Part no.	72/7.0/9.0/1.4'	145mm	80g

- \* Designed for stripping and cutting the cable and wire up to 2mm diameter.
- \* Serrated edges can prevent objects from slipping away.
- \* Impact grips designed to fit human body engineering for the comfort of holding
- \* The inner ring of grips are made of TPR soft material. Fingers won't hurt after a long time holding.
- \* With an adjustable joint screw.



**Straight shears**

<b>5055P1</b>		<i>l</i>	
Part no.	Cutting Length	mm	g
5055P108	40mm	203-8"	340
5055P1	51mm	254-10"	480
5055P112	70mm	305-12"	650



**Aviation tin snips**

<b>698...</b>		<i>l</i>	<i>l</i>	
Part no.	Direction	mm	CuttingL	g
6981250	Straight cut	250	38mm	400
698L248	Left cut	248	35mm	400
698R248	Right cut	248	35mm	400



**20pcs Feeler gauge**

<b>618</b>		<i>l</i>	
Part no.	100/10.4/11.4/1.1'	105mm	104g

included 20 blades 0.05mm to 1.00mm

**26pcs Feeler gauge New**

<b>61802</b>		<i>l</i>	
Part no.	100/12.0/13.0/1.1'	95mm	120g

included 26 blades  
 0.04mm(.0015");0.05mm(.002");0.06mm(.0025")  
 0.08mm(.003");0.10mm(.004");0.13mm(.005")  
 0.15mm(.006");0.18mm(.007");0.20mm(.008")  
 0.23mm(.009");0.25mm(.010");0.28mm(.011")  
 0.30mm(.012");0.33mm(.013");0.35mm(.014")  
 0.38mm(.015");0.40mm(.016");0.43mm(.017")  
 0.45mm(.018");0.48mm(.019");0.50mm(.020")  
 0.53mm(.021");0.55mm(.022");0.58mm(.023")  
 0.60mm(.024");0.63mm(.025")



**Measuring tape**

<b>5096P8..</b>			
Part no.	Size	Packing	g
5096P803	3m	100/9.0/10.0/2'	90
5096P8	5m	100/20.0/21.0/2.4'	180
5096P808	8m	60/21.6/22.6/1.8'	270



**Grey cast iron bench vise(without base)**

<b>65401</b>	Jaw	Throat	
Part no.	open	depth	packing
6540104	4"	2-5/8"	1/12.2/13.2/0.43'
6540105	5"	3-1/4"	1/16.0/17.0/0.6'
6540106	6"	3-3/4"	1/21.5/22.5/0.82'
6540108	8"	4"	1/29.2/30.2/0.97'





**All steel swivel base vise**

<b>65402</b>	Jaw	Throat	
Part no.	open	depth	packing
6540204	4"	2-1/4"	1/7.5/8.5/0.4'
6540205	5"	2-5/8"	1/11.0/12.0/0.6'
6540206	6"	3"	1/14.5/15.5/0.8'
6540208	8"	3-1/2"	1/20.5/21.5/1.2'
6540210	10"	4"	1/25.6/26.9/1.5'



**Special vise for shock absorption**

<b>65403</b>		
Part no.	5/16.6/17.6/1.1'	3350g



**Drilling press vise**



<b>65404..</b>	Jaw	Throat	
Part no.	Open	Depth	Packing
6540403	2-3/4"	3/4"	4/8.2/9.2/0.44'
6540404	4"	1"	4/11.0/12.0/0.63'
6540405	5"	1"	4/16.0/17.0/0.77'
6540406	5-1/2"	1"	4/22.5/24.5/1.08'





**Cross vise**

<b>65405..</b>	Jaw	
Part no.	Open	Packing
6540503	3"	1/6.2/7.0/0.31'
6540504	4"	1/10.0/11.0/0.44'
6540505	5"	1/13.5/15.0/0.5'
6540506	6"	1/16.5/18.0/0.65'





<b>LED white light, clip-type (360° rotation)</b>		
<b>68601</b>		
Part no.	120/6.0/7.5/1.9'	50g





<b>Magnetic LED head light</b>		
<b>68603</b>		
Part no.	100/18/19/3'	180g



<b>Limber magnetic LED light</b>		
<b>68602</b>		
Part no.	120/9.2/10.7/3.5'	77g



<b>Dynamo LED torch</b>		
<b>68604</b>		
Part no.	50/11.0/12.0/1.7'	215g

- \* Powered by widening-up
- \* Power switch:  
 Press once - lights on,  
 Press again - lights blinking,  
 Press third - lights off.







**Round magnetic tray**

<b>88001</b>		
Part no.	30/12.0/13.0/1.5'	400g

- \* fl150mmL
- \* Functions:
  1. One heavy duty 1000 ~ 1200 gauss permanent magnets.
  2. Vulcanized rubber coating prevent scuffing and scratching to valuable surface.
  3. Stainless steel tray resists corrosion.
  4. Can be used horizontally, vertically, and upside down.
  5. Convenient for collecting small parts and tools.



**Rectangular magnetic tray (3 magnets)**

<b>88003</b>		
Part no.	12/15.0/16.0/1.4'	1250g

- \* L360mm x W160mm
- \* Functions:
  1. 14-1/8" x 6-1/4" x 1-1/2" rectangle Stainless steel tray.
  2. Three Heavy Duty magnets with durable rubber coating to help prevent scuffing and scratching.
  3. Great for small parts, fasteners and tools.
  4. Can be used horizontally, vertically or upside down.





**Rectangular magnetic tray (2 magnets)**

<b>88002</b>		
Part no.	30/12.0/13.0/1.5'	400g

- \* L242mm x W132mm
- \* Functions:
  1. 5-1/2" x 9-1/2" x 1-1/2" rectangle Stainless steel tray.
  2. Two Heavy Duty magnets with durable rubber coating to help prevent scuffing and scratching.
  3. Great for small parts, fasteners and tools.
  4. Can be used horizontally, vertically or upside down.



**Square magnetic tray**

<b>88004</b>		
Part no.	6/8.5/9.5/1.1'	1420g

- \* L293mm x W270mm
- \* Functions:
  1. Square Stainless steel tray.
  2. Heavy Duty magnets with durable rubber coating to help prevent scuffing and scratching
  3. Great for small parts, fasteners and tools
  4. Can be used horizontally, vertically or upside down



**EZ-release magnetic pick-up**

<b>88011</b>		
Part no.	20/11.5/13.0/3.4'	575g

\*680mmL(26-3/4")

\*Capacity: 8 LDBS (3.63 kgw)

\*Functions:

1. EZ- Release magnetic pick up tool has a magnetic device that is able to attract any metallic items or spare parts laying on the floor without having to go through the trouble and pick them up one by one.
2. Pull the trigger and drop the items easily.
3. Easy clean up the work zone in factory, house or shop.
4. Easy to use, safe and practical time saving device.
5. Permanent magnet.



**Midi EZ-release magnetic pick-up**

<b>88012</b>		
Part no.	24/15.1/16.6/2.5'	630g

\* 110x110x190mm

\* Capacity: 10 LDBS (4.54kgw)

\* Functions:

1. Easy pick-up and release of metallic materials.
2. Just squeeze the handle to quickly release material.



**Power EZ-release magnetic pick-up**

<b>88013</b>		
Part no.	20/9.3/10.3/1.5'	465g

\* 400mmL(15-3/4")

\* Capacity: 14 LDBS

\* Functions:

1. Quickly and safely clean up iron, steel chips and waste. Used for safe handling of sharp off cuts, separating small parts and steel scrap for nonferrous surfaces.
2. Adjustable dump guard maximizes pick-up and gives a clean dump.
3. Easy clean up the work zone in factory, house and shop.
4. Powerful permanent magnet; never need to be remagnetized.



**3-in-1 Magnetic flexible pickup tool with light & mirror**

<b>617L</b>		
Part no.	72/15.1/16.1/2'	210g

\* Positive action turn on/off switch

\* Magnetic pick-up 3.5lbs. (1.6kgw)

\* Flexible shank of dia. 8.5mm and length 455mm(17-7/8")

\* Oval glass mirror 25 x 50mm (1-1/8"x2")

\* Replaceable bulb (2.2V, 0.25A)

\* Inspection light is operated with 2pc x AA batteries (not included)



**Multi-function magnetic pick-up**

<b>617</b>		<i>l</i>	
Part no.	100/8.2/9.2/1.1	235mm	82g

- \*Magnetic pick-up tool in telescopic extended, maximum 63cm extension.
- \*Take off the cap of bottom, the needle point head can be used for marking when draw a line or clean the narrow slot and small hole.
- \*Attach a fully adjustable mirror for inspection.
- \*all in one handy tool with pocket clip.



**External thread restorer files**

<b>66901</b>		
Part no.	72/15.0/16.0/1.2'	208g

Metric file / pitch size :  
0.75; 1.00; 1.25; 1.50; 1.75; 2.00; 2.50; 3.00

**External thread restorer files**

<b>66902</b>		
Part no.	72/15.0/16.0/1.2'	208g

SAE file / pitch size :  
11; 12; 13; 14; 16; 18; 20; 24

**External thread restorer files**

<b>66903</b>		
Part no.	72/15.0/16.0/1.2'	208g

SAE file / pitch size :  
9; 10; 12; 16; 20; 27; 28; 32

\*Rostore tool for renewing damaged thread on any diameter bolt, stud, axle of shaft file, both right and left threads.



**1/2" DR. Stud extractor**

<b>818</b>		<i>l</i>		
Part no.	size	mm	g	pc/box
81805	5	60	127	10
81806	6	60	132	10
81807	7	60	130	10
81808	8	60	130	10
81810	10	68	186	10
81812	12	68	184	10
81814	14	68	253	10
8183.16	3/16"	60	126	10
8181.4	1/4"	60	126	10
8185.16	5/16"	60	124	10
8183.8	3/8"	68	176	10
8187.16	7/16"	68	172	10
8181.2	1/2"	68	196	10



**T tap wrench (Ratchet type)**

<b>881...</b>		<i>l</i>	
Part no.	Tap range	mm	g
8812090	0-1/4" (3-6mm)	90	190
8812250	0-1/4" (3-6mm)	250	280
8814110	1/4"-1/2" (6-12mm)	110	320
8814300	1/4"-1/2" (6-12mm)	300	460



**Multi-purpose framework**

<b>63201</b>		
Part no.	100/14.0/15.0/2.9'	140g

\* make our tools orderly.



**Long nose straight long pliers**

**5047P1**

Part no.	packing	mm	g
5047P1	50/16.5/17.5/0.64'	280-11"	330
5047P1L	50/17.5/18.5/0.74'	400-15.7"	480



**Long nose 45B long pliers**

**5047P2**

Part no.	packing	mm	g
5047P2	50/16.5/17.5/0.64'	280-11"	330
5047P2L	50/17.5/18.5/0.74'	400-15.7"	480



**Long nose 90B long pliers**

**5047P3**

Part no.	packing	mm	g
5047P3	50/16.5/17.5/0.64'	280-11"	330
5047P3L	50/17.5/18.5/0.74'	400-15.7"	480



**Multi-purpose 4 points gripping pliers**

**5047P4**

Part no.	packing	mm	g
5047P4	50/16.5/17.5/0.64'	280-11"	330



**Bent long nose pliers**

**610B..B**

Part no.	packing	mm	g
610B150B	50/9.3/10.3/1.1'	150-6"	186
610B200B	50/11.0/12.0/1.9'	200-8"	220



**Mini nose pliers**

**610110**

Part no.	packing	mm	g
610110	120/8.4/9.4/2.4'	140	70

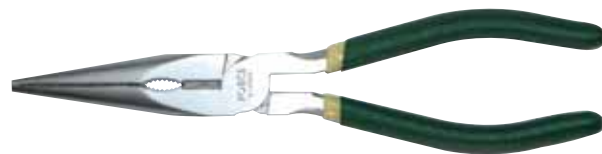

**Long nose pliers**

**610..**

Part no.	packing	mm	g
610150	60/9.7/10.7/1'	150-6"	162
610200	60/15.5/16.5/1.4'	200-8"	258



**Long nose pliers**



**610B..**

Part no.	packing	mm	g
610B145	50/8.0/9.0/1.2'	145-5.7"	160
610B160	50/9.3/10.3/1.2'	160-6.3"	186
610B200	50/11.0/12.0/2'	200-8"	220







**Combination pliers**

<b>611..</b>		<i>l</i>	
Part no.	packing	mm	g
611150	60/12.6/13.6/0.9'	150-6"	210
611175	60/16.8/17.8/1.6'	175-7"	280
611215	50/20.6/21.6/1.2'	215-8.5"	412





**Diagonal pliers**

<b>612..</b>		<i>l</i>	
Part no.	packing	mm	g
612175	60/14.2/15.2/1.3'	175-7"	245





**Combination pliers**

<b>611B..</b>		<i>l</i>	
Part no.	packing	mm	g
611B160	60/15.7/16.7/1.5'	160-6.3"	261
611B175	60/16.8/17.8/2'	175-7"	280
611B200	60/22.8/23.8/1.8'	200-8"	380





**Diagonal pliers**

<b>612B..</b>		<i>l</i>	
Part no.	packing	mm	g
612B160	60/14.3/15.3/1.6'	160-6.3"	238
612B175	60/15.6/16.6/2'	175-7"	260



**Mini diagonal pliers**

<b>612140</b>		<i>l</i>	
Part no.	packing	mm	g
612140	120/7.7/8.7/2'	110	65



**Waterpump pliers**

<b>613..</b>		<i>l</i>	
Part no.	packing	mm	g
613200	60/13.5/14.5/1.5'	200-8"	225
613250	50/23.5/24.5/1.8'	250-10"	470
613300	20/13.5/14.5/1'	300-12"	680
613360	20/19.0/20.0/0.9'	360-14"	950
613410	12/15.6/16.6/0.9'	410-16"	1300



**Heavy duty water pump pliers**

<b>613A..</b>		<i>l</i>	
Part no.	packing	mm	g
613A120	120/4.8/5.8/2'	120	40
613A165	30/4.5/5.5/1.1'	165	150
613A240	60/22.8/23.8/1.8'	240	380
613A300	30/15.9/16.9/0.9'	300	560
613A400	12/15.6/16.6/0.9'	400	1220
613A500	12/20.4/21.4/0.9'	500	1700



**Waterpump pliers**

<b>613B..</b>		<i>l</i>	
Part no.	packing	mm	g
613B250	50/20.5/21.5/1.7'	250-10"	410



**Slip joint pliers**

<b>673B..</b>		<i>l</i>	
Part no.	packing	mm	g
673B160	60/14.3/15.3/1.2'	160-6.3"	238
673B215	60/16.5/17.5/2'	215-8.5"	275
673B250	60/20.4/21.4/2'	250-10"	340



**Hoof nipper**

<b>6961..</b>		<i>l</i>	
Part no.	packing	mm	g
6961300	20/17.4/18.4/0.56'	300-12"	900



**Trim pliers**

<b>6962..</b>		<i>l</i>	
Part no.	packing	mm	g
6962350	20/21.4/22.4/0.8'	350-14"	1070



**Crocodile pliers**

<b>6963..</b>		<i>l</i>	
Part no.	packing	mm	g
6963330	20/14.2/15.2/0.8'	330-13"	710

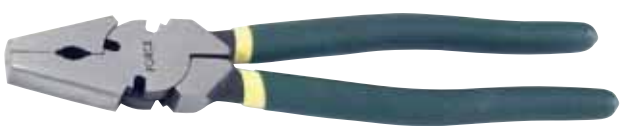

**Fence pliers**

<b>6964..</b>		<i>l</i>	
Part no.	packing	mm	g
6964260	40/20.0/21.0/1'	260-10"	500
6964310	20/14.8/15.8/0.8'	310-12"	740



**Fencing tool**

<b>6965..</b>		<i>l</i>	
Part no.	packing	mm	g
6965265	20/14.1/15.1/0.64'	265-10"	703





**Fishing pliers**

<b>6951..</b>		<i>l</i>	
Part no.	packing	mm	g
6951125	60/25.2/26.2/3.2'	124	420





**Tower pincers**

<b>6971..</b>		<i>l</i>	
Part no.	packing	mm	g
6971230	40/16.8/17.8/0.6'	230	420
6971250	40/19.2/20.2/1.2'	250	480
6971280	30/15.9/16.9/0.9'	280	530



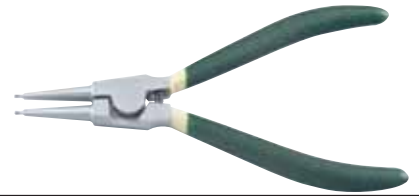

**Carpenter's pincers**

<b>6972..</b>		<i>l</i>	
Part no.	packing	mm	g
6972180	60/18.9/19.9/1.2'	180	315



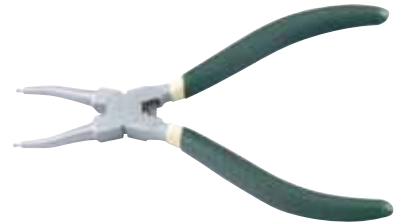

**Snap ring pliers (External straight tip 1.8mm)**

<b>609..ASO</b>			<i>l</i>	
Part no.	Capacity	packing	mm	g
60905ASO	8-25mm	30/2.4/3.4/1.0'	140-5.5"	80
609ASO	19-60mm	30/4.5/5.5/1.1'	180-7"	160
60909ASO	40-100mm	30/9.0/11.0/1.2'	230-9"	300





**Snap ring pliers (Internal straight tip 1.8mm)**

<b>609..ASC</b>			<i>l</i>	
Part no.	Capacity	packing	mm	g
60905ASC	8-25mm	30/2.4/3.4/1.0'	140-5.5"	80
609ASC	19-60mm	30/4.5/5.5/1.1'	180-7"	160
60909ASC	40-100mm	30/9.0/11.0/1.2'	230-9"	300





**Snap ring pliers (External 90° Bent tip 1.8mm)**

<b>609..ABO</b>			<i>l</i>	
Part no.	Capacity	packing	mm	g
60905ABO	8-25mm	30/2.4/3.4/1.0'	140-5.5"	80
609ABO	19-60mm	30/4.5/5.5/1.1'	180-7"	160
60909ABO	40-100mm	30/9.0/11.0/1.2'	230-9"	300



**Snap ring pliers (Internal 90° Bent tip 1.8mm)**

<b>609..ABC</b>			<i>l</i>	
Part no.	Capacity	packing	mm	g
60905ABC	8-25mm	30/2.4/3.4/1.0'	140-5.5"	80
609ABC	19-60mm	30/4.5/5.5/1.1'	180-7"	160
60909ABC	40-100mm	30/9.0/11.0/1.2'	230-9"	300

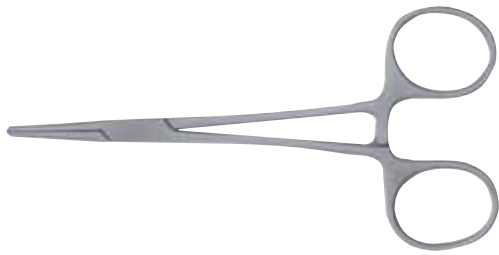

**Straight non-toothed self-locking pliers**

<b>6931</b>	<i>l</i>	<i>l</i>	
Part no.	L(inch)	L(mm)	g
6931125	4.9	125	12
6931140	5.5	140	12
6931160	6.3	160	12
6931200	7.9	200	12

\*Feature:

- Matt finish
- Hot drop-forged
- 3 step lock function
- Box-joint construction
- Stainless special grade steel



**Straight 1x2 teeth self-locking pliers**

<b>6933</b>	<i>l</i>	<i>l</i>	
Part no.	L(inch)	L(mm)	g
6933140	5.5	140	12
6933160	6.3	160	12
6933180	7.1	180	12
6933200	7.9	200	12

\*Feature:

- Matt finish
- Hot drop-forged
- 3 step lock function
- Box-joint construction
- Stainless special grade steel



**Curved non-toothed self-locking pliers**

<b>6932</b>	<i>l</i>	<i>l</i>	
Part no.	L(inch)	L(mm)	g
6932140	5.5	140	12
6932180	7.1	180	12
6932200	7.9	200	12

\*Feature:

- Matt finish
- Hot drop-forged
- 3 step lock function
- Box-joint construction
- Stainless special grade steel

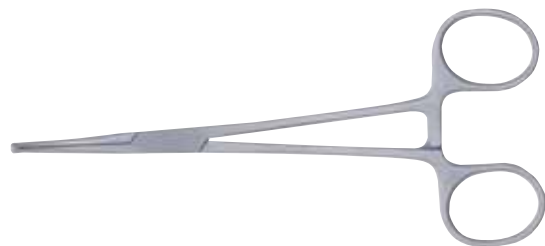

**Curved 1x2 teeth self-locking pliers**

<b>6934</b>	<i>l</i>	<i>l</i>	
Part no.	L(inch)	L(mm)	g
6934125	4.9	125	12
6934140	5.5	140	12
6934160	6.3	160	12
6934180	7.1	180	12
6934200	7.9	200	12

\*Feature:

- Matt finish
- Hot drop-forged
- 3 step lock function
- Box-joint construction
- Stainless special grade steel







**Intricate cutting scissors**

<b>6936</b>	<i>l</i>	<i>l</i>	
Part no.	L(inch)	L(mm)	g
6936140	5.5	140	12
6936145	5.7	145	12
6936160	6.3	160	12
6936180	7.1	180	12
6936200	7.9	200	12

\*Feature:

- Sharp / Sharp straight
- Matt finish
- Hot drop-forged
- Stainless special grade steel



**Intricate cutting scissors**

<b>6938</b>	<i>l</i>	<i>l</i>	
Part no.	L(inch)	L(mm)	g
6938140	5.5	140	12
6938145	5.7	145	12
6938160	6.3	160	12
6938170	6.7	170	12
6938200	7.9	200	12

\*Feature:

- Blunt / Blunt curved
- Matt finish
- Hot drop-forged
- Stainless special grade steel



**Intricate cutting scissors**

<b>6937</b>	<i>l</i>	<i>l</i>	
Part no.	L(inch)	L(mm)	g
6937140	5.5	140	12
6937160	6.3	160	12
6937170	6.7	170	12
6937180	7.1	180	12

\*Feature:

- Blunt / Blunt straight
- Matt finish
- Hot drop-forged
- Stainless special grade steel



**Intricate cutting scissors**

<b>6939</b>	<i>l</i>	<i>l</i>	
Part no.	L(inch)	L(mm)	g
6939140	5.5	140	12
6939160	6.3	160	12
6939180	7.1	180	12

\*Feature:

- Sharp / Blunt curved
- Matt finish
- Hot drop-forged
- Stainless special grade steel



**High-precision specialized tweezers**

<b>6941</b>	<i>l</i>	<i>l</i>	
Part no.	L(inch)	L(mm)	g
6941125	4.9	125	10
6941160	6.3	160	10
6941180	7.1	180	10

- \*Feature:  
 Straight non-toothed  
 Matt finish  
 Drop-forged  
 Stainless special grade steel



**High-precision specialized tweezers**

<b>6942</b>	<i>l</i>	<i>l</i>	
Part no.	L(inch)	L(mm)	g
6942125	4.9	125	10
6942140	5.5	140	10
6942180	7.1	180	10
6942200	7.9	200	10

- \*Feature:  
 Straight 1x2 teeth  
 Matt finish  
 Drop-forged  
 Stainless special grade steel



**High-precision specialized tweezers**

<b>6943</b>	<i>l</i>	<i>l</i>	
Part no.	L(inch)	L(mm)	g
6943125	4.9	125	10

- \*Feature:  
 Angular non-toothed  
 Matt finish  
 Drop-forged  
 Stainless special grade steel



**High-precision specialized tweezers**

<b>6944</b>	<i>l</i>	<i>l</i>	
Part no.	L(inch)	L(mm)	g
6944160	6.3	160	10

- \*Feature:  
 Angular smooth-jaw  
 Matt finish  
 Drop-forged  
 Stainless special grade steel



**High-precision specialized tweezers**

<b>6945</b>	<i>l</i>	<i>l</i>	
Part no.	L(inch)	L(mm)	g
6945170	6.7	170	10

- \*Feature:  
 Z-shaped needle-tip  
 Matt finish  
 Drop-forged  
 Stainless special grade steel



**Rivet pliers**

<b>67801</b>		<i>l</i>	
Part no.	packing	mm	g
67801	20/15.7/16.7/2.1'	180	785



**Grade nut fastener**

<b>67802</b>		<i>l</i>	
Part no.	packing	mm	g
67802	20/11.6/12.6/2.1'	280	582





**Tie down pliers**

<b>54111P1</b>		<i>l</i>	
Part no.	packing	mm	g
54111P1	60/13/14/3.4'	170	216





**4-in-1 Electrical pliers**

<b>6921..</b>		<i>l</i>	
Part no.	packing	mm	g
6921160	60/9.6/10.6/1.2'	160-6"	160





**Diagonal cutting pliers**

<b>6922..</b>		<i>l</i>	
Part no.	packing	mm	g
6922160	60/12.0/13.0/1.6'	160-6"	200





**Cable cutter**

<b>6923</b>		<i>l</i>	
Part no.	packing	mm	g
6923160	60/9.6/10.6/1.6'	160	180
6923200	60/18.0/19.0/1.6'	200	300
6923250	60/22.2/23.2/1.5'	250	370





**Cable cutter**

<b>6924</b>		<i>l</i>	
Part no.	packing	mm	g
6924250	40/21.2/22.2/0.9'	250	530





**Plastic cutting pliers**

<b>6925</b>		<i>l</i>	
Part no.	packing	mm	g
6925160	60/8.4/9.4/1.3'	160	140
6925180	60/10.8/11.8/1.5'	180	180





**Wire stripper pliers**

<b>6804B160</b>		
Part no.	packing	mm
6804B160	60/9.6/10.6/1.3'	160
	Length: 160mm-6.3"	





**Terminal pliers red, blue, yellow**

<b>6801</b>			
Part no.	packing	mm	g
6801	30/15.8/16.8/1.5'	233	528





**Stripper pliers**

<b>6804</b>			
Part no.	packing	mm	g
6804	50/10.3/11.3/1.2'	178	206





**Terminal pliers 0.5; 0.75; 1.0; 1.5; 2.5; 4**

<b>6802</b>			
Part no.	packing	mm	g
6802	30/16.5/17.5/1.5'	233	549





**Heavy duty stripper pliers**

<b>6805</b>			
Part no.	packing	mm	g
6805	60/21.0/22.0/2'	210	311



**Terminal pliers 0.5-1; 1.1-2.5; 4-6**

<b>6803</b>			
Part no.	packing	mm	g
6803	30/16.1/17.1/1.5'	233	535

- \*Cut and strip 10-24 AWG copper or aluminum wire, solid or stranded
- \*Crimp 10-22 AWG insulated terminals
- \*Crimp 4-22 AWG non-insulated terminals
- \*Crimp 7-8 mm ignition terminals







**Insulated combination pliers**

<b>6901..</b>		<i>l</i>	
Part no.	packing	mm	g
6901215	30/15.8/16.8/1'	215-8-1/2"	528





**Insulated bent nose pliers**

<b>6902..</b>		<i>l</i>	
Part no.	packing	mm	g
6902160	60/11.1/12.1/0.64'	160-6"	185
6902200	60/17.4/18.4/0.93'	200-8"	290





**Insulated combination pliers**

<b>6903..</b>		<i>l</i>	
Part no.	packing	mm	g
6903160	60/15.0/16.0/0.93'	160-6"	250
6903180	60/18.0/19.0/0.93'	180-7"	300
6903200	60/22.5/23.5/1.3'	200-8"	375





**Insulated long nose pliers**

<b>6904..</b>		<i>l</i>	
Part no.	packing	mm	g
6904160	60/11.1/12.1/0.64'	160-6"	185
6904200	60/17.4/18.4/0.9'	200-8"	290



**Insulated diagonal cutting pliers**

<b>6905..</b>		<i>l</i>	
Part no.	packing	mm	g
6905160	60/14.4/15.4/0.9'	160-6"	240





**Insulated water pump pliers (Curved jaw)**

<b>6907..</b>		<i>l</i>	
Part no.	packing	mm	g
6907250	30/16.8/17.8/1.5'	250-10"	280





**Insulated long round nose pliers**

<b>6908..</b>		<i>l</i>	
Part no.	packing	mm	g
6908160	60/10.2/11.2/0.64"	160-6"	170



**Insulated cable cutter**

<b>6909..</b>		<i>l</i>	
Part no.	packing	mm	g
6909250	30/15.9/16.9/1'	250-10"	530



**Insulated diagonal pliers**

6911..		<i>l</i>	
Part no.	packing	mm	g
6911180	60/15.3/16.3/0.93'	180-7"	255
6911200	60/17.4/18.4/0.93'	200-8"	290



**Induction circuit tester**

2125P1		<i>l</i>	
Part no.	packing	mm	g
2125P1	100/8.6/9.6/4.5'	165	86



**Insulated wire stripper pliers**

6912..		<i>l</i>	
Part no.	packing	mm	g
6912160	60/11.4/12.4/1.6'	160-6"	190

**Screwdriver probe voltage tester**

88401		<i>l</i>	
Part no.	packing	mm	g
88401	200/6.5/7.5/2'	145mm	33g

Testing range: 110~250V AC.



**Screwdriver probe voltage tester**

88402		<i>l</i>	
Part no.	packing	mm	g
88402	200/9.5/10.5/2.2'	190mm	48g

Testing range: 110~250V AC.



**Screwdriver probe voltage tester**

88403		<i>l</i>	
Part no.	packing	mm	g
88403	200/9.0/10.0/2.2'	145mm	45g

Testing range: 80~250V AC.



**Screwdriver probe voltage tester**

88404		<i>l</i>	
Part no.	packing	mm	g
88404	200/11.0/12.0/2.6'	190mm	55g

Testing range: 110~250V AC.



**Insulated flat nose pliers**

6913..		<i>l</i>	
Part no.	packing	mm	g
6913160	60/12.0/13.0/0.64'	160-6"	200



**Insulated cable cutter**

6914..		<i>l</i>	
Part no.	packing	mm	g
6914160	60/10.8/11.8/1.3'	160-6"	180
6914200	60/18.0/19.0/1.5'	200-8"	300





**Heavy duty Solenoid voltage continuity tester**

**88405**

Part no.	60/18.0/19.0/2.9'	185mm	300g
----------	-------------------	-------	------

Testing range: 6~600V AC. / DC.



**Universal voltage tester**

**88408**

Part no.	60/9.7/10.7/2.6'	210mm	162g
----------	------------------	-------	------

Testing range: 6~400V AC.



**Electric voltage detector with buzzer**

**88406**

Part no.	180/7.0/8.5/2'	155mm	39g
----------	----------------	-------	-----

Testing range: 100~600V AC.



**Auto battery and charging system analyzer**

**88424**

Part no.	200/9.0/10.0/2.7'	115mm	45g
----------	-------------------	-------	-----

Checks 12 volt system



**Adjustable non-contact wire tracer**



**88407**

Part no.	100/5.1/6.1/1.9'	160mm	51g
----------	------------------	-------	-----

Testing range: 12~600V AC.





**Locking pliers**

<b>614</b>		<i>l</i>	
Part no.	packing	mm	g
614125	40/7.6/8.6/0.7'	125-5"	190
614175	40/14.8/15.8/0.96'	175-7"	370
614250	40/22.0/23.0/1'	250-10"	550



**Long nose locking pliers**

<b>615</b>		<i>l</i>	
Part no.	packing	mm	g
615150	50/10.3/11.3/1.1'	150-6"	220
615225	50/19.5/20.5/1.2'	225-9"	390





**10" Shark wrench**

<b>65201</b>		
Part no.	24/15.0/16.0/1.1'	625g

\* Specially designed grooved jaw for better gripping ability.





**Adjustable locking pliers**

<b>65202</b>		<i>l</i>	
Part no.	Jaw	Length	Weight
65202	3-46mm	9"(215mm)	400

\* For clamping plumbing and worn screws  
 \* Can be adjusted for clamping small to large screws  
 \* Smooth and fast screw clamping and releasing  
 \* Material: Jaw Cr-Mo; Body: Cr-Mo



**Locking "C" clamp with easy release**

<b>660</b>			
Part no.	size	packing	g
66006	6"	72/16.6/17.6/0.67'	236
66011	11"	30/22.5/23.5/1.2'	750
66018	18"	20/21.6/22.6/1.1'	1200



**Sheet metal tool**

<b>66101</b>		
Part no.	48/22.0/23.0/1.2'	458g



**Welding clamp**

<b>66201</b>		
Part no.	40/22.8/23.8/1.4'	600g





**Self-locking multi-grip pliers**  
**Wide flat jaws**

**67901**



*l*



Part no.	36/19.5/20.5/1.9'	200mm	540g
----------	-------------------	-------	------

\* Chrome-plated.  
\* For spot welding



**Self-locking multi-grip pliers**  
**Angled jaws**

**67904**



*l*



Part no.	36/17.0/18.0/0.5'	210mm	474g
----------	-------------------	-------	------

\* Chrome-plated.  
\* For 90... edged metal sheets.



**Self-locking multi-grip pliers**  
**Double curved jaws**

**67902**



*l*



Part no.	36/19.9/20.9/1.1'	200mm	554g
----------	-------------------	-------	------

\* Chrome-plated.  
\* For assembling angular shapes.



**Self-locking multi-grip pliers**  
**Straight jaws**

**67905**



*l*



Part no.	36/16.6/17.6/0.5'	200mm	460g
----------	-------------------	-------	------

\* Chrome-plated.  
\* For flat metal sheets.



**Self-locking multi-grip pliers**  
**Wide curved jaws**

**67903**



*l*



Part no.	36/18.0/19.0/1.1'	210mm	500g
----------	-------------------	-------	------

\* Chrome-plated.  
\* For spot welding of metal sheets with 90... angled edges.



**Bolt cutter**

**9U0501..**

Part no.	packing	Length	g
9U050112	20/14.0/16.0/1'	300-12"	700
9U050114	20/20.8/23.0/1.1'	355-14"	1040
9U050118	15/30.0/32.0/1.8'	455-18"	1500
9U050124	6/25.0/27.0/1.5'	610-24"	2500
9U050130	6/24.0/26.0/1.3'	762-30"	4000
9U050136	5/30.0/32.5/1.8'	863-36"	6000



**Adjustable gauged wrench**

**649**

Part no.	size	packing	mm	g
649150	20mm	100/17.0/18.0/1.6'	150	170
649200	24mm	60/17.4/18.4/2.1'	200	290
649250	29mm	30/15.0/16.0/1.5'	250	500
649300	33mm	20/15.3/16.3/1.2'	300	765
649375	46mm	12/15.6/16.6/1.3'	375	1300
649450	60mm	10/19.0/20.0/0.7'	450	2150
649600	70mm	8/30.0/31.0/1'	600	3700



**Aluminum pipe wrench**

**684...A**

Part no.	packing	Length	g
68410A	24/11.0/12.0/0.4'	250-10"	460
68412A	24/17.0/18.0/0.4'	300-12"	700
68414A	24/21.5/22.5/0.5'	355-14"	895
68418A	12/18.0/19.0/0.9'	455-18"	1500
68424A	6/14.0/15.0/0.7'	610-24"	2330
68436A	3/14.0/15.0/1.1'	863-36"	4660
68448A	2/13.0/14.0/1.8'	1220-48"	6900



**Adjustable gauged wrench**

**649..A**

Part no.	size	packing	mm	g
649100A	17mm	100/9.0/10.0/1.4'	100	90
649150A	24mm	100/14.0/15.0/1.2'	150	140
649200A	28mm	50/13.0/14.0/1'	200	260
649250A	33mm	30/12.7/13.7/0.77'	250	423
649300A	38mm	20/15.3/16.3/1.2'	300	765
649375A	51mm	12/14.3/15.3/0.9'	375	1191



**Pipe wrench**

**684...**

Part no.	packing	Length	g
68408	36/14.0/15.0/0.4'	200-8"	390
68410	24/17.0/18.0/0.4'	250-10"	710
68412	24/23.0/24.0/0.5'	300-12"	960
68414	12/16.0/17.0/0.4'	355-14"	1340
68418	12/25.0/26.0/0.6'	455-18"	2090
68424	6/22.0/23.0/0.7'	610-24"	3670
68436	3/25.0/26.0/1.1'	863-36"	8340
68448	2/24.0/25.0/1.4'	1220-48"	12000



**Adjustable gauged wrench**

**649..B**

Part no.	size	packing	mm	g
649200B	24mm	60/18.0/19.0/2.1'	200	290
649250B	29mm	30/15.0/16.0/1.5'	250	500
649300B	33mm	20/15.3/16.3/1.3'	300	765



**Tone control torques wrench**

<b>647</b>	Capacity		<i>l</i>	
Part no.	Nm	Packing	mm	g
6472270	1/4"DR.	20/14.4/15.4/1.14'	270	720
	5-25			
6473270	3/8"DR.	20/14.8/15.8/1.14'	270	750
	5-25			
6473365	19-110	20/21.0/22.0/1.14'	365	1050
6474470	1/2"DR.	12/20.2/21.2/1.1'	470	1650
	42-210			
6474630	70-350	10/29.0/30.0/1.4'	630	2900
6476850	3/4"DR.	4/19.0/20.0/1.7'	850	4633
	80-400			
64761030	140-700	4/30.0/31.0/1.67'	1030	7500
64761215	140-980	2/15.0/16.0/0.8'	1215	7500
64781215	1"DR.	2/15.0/16.0/0.8'	1215	7500
	140-980			

**Tone control torques wrench**

<b>647</b>	Capacity		<i>l</i>	
Part no.	Inch-lb	Packing	mm	g
6472270S	1/4"DR.	20/14.4/15.4/1.14'	270	720
	10-200			
6473270S	3/8"DR.	20/14.8/15.8/1.14'	270	750
	10-200			

**Tone control torques wrench**

<b>647</b>	Capacity		<i>l</i>	
Part no.	Ft-lb	Packing	mm	g
6473365S	3/8"DR.	20/21.0/22.0/1.14'	365	1050
	5-80			
6474470S	1/2"DR.	12/20.2/21.2/1.1'	470	1650
	10-150			
6474630S	50-250	10/29.0/30.0/1.4'	630	2900
6476850S	3/4"DR.	4/19.0/20.0/1.7'	850	4633
	50-300			
64761030S	100-500	4/30.0/31.0/1.67'	1030	7500
64761215S	100-700	2/15.0/16.0/0.8'	1215	7500
64781215S	1"DR.	2/15.0/16.0/0.8'	1215	7500
	100-700			

\*Spare part available



**Lock torques wrench(Tone control)**

<b>647</b>	Capacity		<i>l</i>	
Part no.	Nm	Packing	mm	g
6472295	1/4"DR.	20/17.2/18.2/1.63'	295	860
	6-30			
6473295	3/8"DR.	20/17.2/18.2/1.63'	295	860
	6-30			
6473380	19-110	12/15.3/16.3/1.57'	380	1200
6474535	1/2"DR.	10/20.3/21.3/1.31'	535	2030
	40-210			
6474660	70-350	6/18.4/19.4/0.92'	660	3060
6476880	3/4"DR.	4/19.5/20.5/1.8'	880	4875
	100-500			
64761095	140-700	4/30.0/31.0/1.8'	1095	7500
64761240	140-980	2/16.0/17.0/1'	1240	8000
64781240	1"DR.	2/16.0/17.0/1'	1240	8000
	140-980			

**Lock torques wrench(Tone control)**

<b>647</b>	Capacity		<i>l</i>	
Part no.	Inch-lb	Packing	mm	g
6472295S	1/4"DR.	20/17.2/18.2/1.63'	295	860
	50-250			
6473295S	3/8"DR.	20/17.2/18.2/1.63'	295	860
	50-250			

**Lock torques wrench(Tone control)**

<b>647</b>	Capacity		<i>l</i>	
Part no.	Ft-lb	Packing	mm	g
6473380S	3/8"DR.	12/15.3/16.3/1.57'	380	1200
	15-80			
6474535S	1/2"DR.	10/20.3/21.32/1.31'	535	2030
	30-150			
6474660S	50-250	6/18.4/19.4/0.92'	660	3060
6476880S	3/4"DR.	4/19.5/20.5/1.8'	880	4875
	50-300			
64761095S	100-500	4/30.0/31.0/1.8'	1095	7500
64761240S	100-700	2/16.0/17.0/1'	1240	8000
64781240S	1"DR.	2/16.0/17.0/1'	1240	8000
	100-700			

\*Spare part available



**Lock torques wrench-window display(Tone control)**

<b>647..W</b>	Capacity		$l$	
Part no.	Inch-lb	Packing	mm	g
6472300W	1/4"DR. 6-30Nm 40-250in-lb	20/16.0/17.0/1.63'	300	800
6473420W	3/8"DR. 70-100Nm 15-75ft-lb	12/16.8/17.8/1.57'	420	1400
6474530W	1/2"DR. 40-200Nm 30-150ft-lb	10/16.0/17.0/1.31'	530	1600

\*Spare part available



**Lock torques wrench-window display**

<b>647..W</b>	Capacity		$l$	
Part no.	Nm	Packing	mm	g
6472220W	1/4"DR. 6-30Nm	20/16.0/17.0/1.63'	220	750
6473350W	3/8"DR. 30-110Nm	12/16.8/17.8/1.57'	350	1350
6474380W	1/2"DR. 30-200Nm	10/16.0/17.0/1.31'	380	1500

\*Spare part available



**Mechanical Torque Multipliers**

<b>651</b>	Capacity	Square Drive	Input:Output
Part no.	Nm	size	
65101	1350	1/2" to 3/4"	1:3
65102	2700	3/4" to 1"	1:3

<b>651</b>	Rotation rate		
Part no.	Nm	Packing	g
65101	4:1	4/14.4/15.4/0.75'	3600
65102	4:1	4/19.4/20.4/1'	4850

\*Spare part available  
\*Impact use is prohibited



**Torque adapter (spark plug special)**

<b>832..</b>		Torque	$l$	
Part no.	size	Nm	mm	g
832318	3/8"DR.	18	52	170
832324	3/8"DR.	24	52	170



**Torque wrench calibrator**

<b>6991015</b>		
Part no.	1/8.86/9.5/18.2'	88.6kg

- \* ETS Display AC 110C/220V
- \* TRANSDUCER 40~1000Nm
- \* LOADER 1500mmL
- \* The test and report software included





**Flexible hex nut driver**

<b>648...</b>		<i>l</i>	<i>l</i>		
Part no.	size	Blade	over	g	Pc/carton
648055	5.5	160	270	190	60/2.4'
64806	6	160	270	192	60/2.4'
64807	7	160	270	196	60/2.4'
64808	8	160	270	198	60/2.4'
6481.4	1/4"	160	270	192	60/2.4'
6485.16	5/16"	160	270	198	60/2.4'



**Flexible hex nut driver**

<b>648...L</b>		<i>l</i>	<i>l</i>		
Part no.	size	L	over	g	Pc/carton
648055L	5.5	500	630	275	60/2.4'
64806L	6	500	630	275	60/2.4'
64807L	7	500	630	275	60/2.4'
64808L	8	500	630	275	60/2.4'



**Flexible hex nut driver**

<b>648..</b>		<i>l</i>	<i>l</i>		
Part no.	size	Blade	over	g	Pc/carton
6480607	6x7	190	290	220	60/2.4'

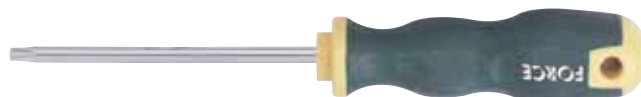

**Spline screwdriver M4**

<b>71817004A</b>		<i>l</i>		
Part no.	M4	80mm	35g	10PC

\* For removing & fitting the internal covering of tail lamps and dashboards as fitted to the Golf IV & new AUDI / VW models.

\* For door handle VW passat and Golf IV.



**Adjustment phillips screwdriver**

<b>6551..</b>		<i>l</i>	<i>l</i>		
Part no.	size	Blade	over	g	pc/box
65511	PH.1	350	450	75	5
65512	PH.2	350	450	75	5



**Adjustment phillips screwdriver**

<b>6551...L</b>		<i>l</i>	<i>l</i>		
Part no.	size	Blade	over	g	pc/box
65512L	PH.2	400	515	215	5

**Adjustment pozidriv screwdriver**

<b>6552...L</b>		<i>l</i>	<i>l</i>		
Part no.	size	Blade	over	g	pc/box
65522L	PZ.2	400	515	215	5



**Adjustment slotted screwdriver**

<b>6553..</b>		<i>l</i>	<i>l</i>		
Part no.	size	Blade	over	g	pc/box
655304	4	300	400	65	10
655305	5	300	400	65	10
655306	6	300	400	65	5
655308	8	300	400	70	5





**Adjustment slotted screwdriver**

<b>6553...L</b>		<i>l</i>	<i>l</i>		
Part no.	size	Blade	over	g	pc/box
6553065L	6.5	400	515	215	5



**Rim wrench**

<b>677..</b>		<b>l</b>		
Part no.	Size	mm	g	pc/box
6772224	22x24	400	1300	5
6772427	24x27	400	1320	5
6772730	27x30	400	1330	5
6772732	27x32	400	1380	5
6772733	27x33	400	1400	5
6772833	28x33	400	1410	5
6773032	30x32	400	1440	5
6773233	32x33	400	1495	5
6773238	32x38	400	1535	5
6773821	38x21sq.	400	1520	5
6774121	41x21sq.	400	1550	5





**Wrench bar**

<b>677..</b>		<b>l</b>	
Part no.	Size	mm	g
67701	19	630	1400
67702	25	630	3500

\*67702 only for 6773821 and 6774121





**Foldable cross-handle socket wrench**

<b>681...</b>			
Part no.	Packing		g
681400	16/18.7/19.7/1.3'		1170
681500	16/23.4/24.4/1.57'		1463

Socket size: 17mm; 19mm; 21mm; 1/2" square  
 Length: 681400: 16" = 400mmL  
 681500: 20" = 500mmL





**Assembly wheel nut wrench**

<b>681A300</b>			
Part no.	20/23.0/24.0/0.64'		1150g
681A300	17mm; 19mm; 13/16"; 1/2"DR. (300mmL)		
	* Chrome vanadium alloy steel		
	* For most car wheel nuts in metric		
	* Polished, chrome plated		



**Wheel nut wrench**

<b>681B400</b>			
Part no.	12/16.8/17.3/0.9'		1600g
681B400	17; 19; 21; 22 mm with 1/2"DR. Adapter (400mmL)		
	* Chrome vanadium alloy steel		
	* For most car wheel nuts in metric		
	* Polished, chrome plated		



**Wheel balancing weight tool**

<b>6821</b>		<i>l</i>	
Part no.	30/11.6/12.6/1.2'	245mm	388g



**1/2" Pentagon socket bit 10mm side**

<b>65001</b>		<i>l</i>		
Part no.	Bit	55mm	94g	10pc

\*Application on girling brakes.



**Tyre lever**

<b>750500</b>			
Part no.	packing	mm	g
750500	30/22/23/0.75'	500	732



**1/2"DR. Bent hex socket bit**

<b>34410508B</b>		<i>l</i>		
Part no.	size	length	weight	pcs/box
34410508B	8mm	105mm	92gw	10





**Brake spanner**

<b>608</b>		<i>l</i>		
Part no.	size	mm	g	pc/box
6080610	1/4"Sq.-10mmSq.	175	82	10
6080608	1/4"Sq.-5/16"OE.	175	84	10
6080810	8mmHex.-10mmHex.	175	82	10
6080911	9mmHex.11mmHex.	175	100	10
6080607	1/4"Hex.-7mmHex.	175	84	10
6081109	7/16"OE.-11/32"Sq.	175	100	10
6081114	7/16"OE.-9/16.OE.	175	102	10
6081113	11mmOE.-13mmOE.	175	108	10
6081011	10mmOE.-11mmOE.	175	92	10





**3/8" DR. Universal T45**

<b>336..U</b>		<i>l</i>		
Part no.	Tip	mm	g	pc/box
33645U	T45	65	68	10
33650U	T50	65	70	10





**3/8" DR. Magnetic Long Spark plug socket**

<b>8073250..M</b>		<i>l</i>		
Part no.	socket	mm	g	pc/box
807325014M	14mm	250	316	10
807325016M	16mm	250	344	10
807325020.6M	20.6mm	250	440	10

\* 807325014M for Citroën C5 HPI, Peugeot 406 HPI, Renault Clio 1,2 16V; Twingo 1,2 16V.





**1/2" DR. Splines Security socket bit**

<b>348..T</b>		<i>l</i>		
Part no.	size	mm	g	pc/box
34805516T	M16	55	142	10
34810016T	M16	100	270	10

\* For removal and replacement of the gear box drain plug Audi A3, A4, A6; VW Golf IV, LT.





**1/2" DR. Magnetic Spark plug socket**

<b>8074..M</b>		<i>l</i>		
Part no.	size	mm	g	pc/box
807416M	16mm	70	86	10
807418M	18mm	70	146	10
807420.6M	20.6mm	70	148	10

\* E20 For HGV Cylinder-head bolts.





**3/4" DR. Star impact deep socket**

<b>466110</b>		<i>l</i>		
Part no.	socket	mm	g	pc/box
46611018	E18	110	520	1
46611020	E20	110	540	1

\* E20 For HGV Cylinder-head bolts.





**1/2" DR. Vacuum switch socket**

<b>44322</b>		<i>l</i>		
Part no.	size	mm	g	pc/box
44322	22	85	200	10







**3/8" DR. Universal Spark plug socket (ball type)**

<b>8073..B</b>		<i>l</i>		
Part no.	socket	mm	g	pc/box
807316B	16mm	95	114	10
807320.6B	20.6mm	95	150	10





**3/8" DR. Universal Spark T wrench (ball type)**

<b>8073..B</b>		<i>l</i>		
Part no.	socket	mm	g	pc/box
807330016B	16mm	300	354	40
807330020.6B	20.6mm	300	392	40
807350016B	16mm	500	552	40
807350020.6B	20.6mm	500	590	40





**3/8" DR. Universal Spark plug socket Magnetic (ball type)**

<b>8073..BM</b>		<i>l</i>		
Part no.	socket	mm	g	pc/box
807316BM	16mm	95	118	10
807320.6BM	20.6mm	95	154	10





**3/8" DR. Universal Spark T wrench Magnetic (ball type)**



<b>8073..BM</b>		<i>l</i>		
Part no.	socket	mm	g	pc/box
807330016BM	16mm	300	356	40
807330020.6BM	20.6mm	300	394	40
807350016BM	16mm	500	554	40
807350020.6BM	20.6mm	500	592	40



**3/8" DR. Universal spark plug socket  
Magnetic (joint type)**



<b>8073..UM</b>		<i>l</i>		
Part no.	socket	mm	g	pc/box
807316UM	16mm	95	114	10
807320.6UM	20.6mm	95	150	10

**1/2" DR. Universal spark plug socket  
Magnetic (joint type)**



<b>8074..UM</b>		<i>l</i>		
Part no.	socket	mm	g	pc/box
807416UM	16mm	100	102	10
807420.6UM	20.6mm	100	164	10



**3/8" DR. Universal spark plug socket  
(joint type)**



<b>8073..U</b>		<i>l</i>		
Part no.	socket	mm	g	pc/box
807316U	16mm	95	114	10
807320.6U	20.6mm	95	150	10

**1/2" DR. Universal spark plug socket  
(joint type)**



<b>8074..U</b>		<i>l</i>		
Part no.	socket	mm	g	pc/box
807416U	16mm	100	102	10
807420.6U	20.6mm	100	164	10



**3/8" DR. Universal spark T wrench  
Magnetic (joint type)**



<b>8073..UM</b>		<i>l</i>		
Part no.	socket	mm	g	pc/box
807330016UM	16mm	300	356	40
807330020.6UM	20.6mm	300	394	40
807350016UM	16mm	500	554	40
807350020.6UM	20.6mm	500	592	40
807380016UM	16mm	800	852	15
807380020.6UM	20.6mm	800	890	15

**1/2" DR. Universal spark T wrench  
Magnetic (joint type)**



<b>8074..UM</b>		<i>l</i>		
Part no.	socket	mm	g	pc/box
807430016UM	16mm	300	356	30
807430020.6UM	20.6mm	300	394	30
807450016UM	16mm	500	554	30
807450020.6UM	20.6mm	500	592	30
807480016UM	16mm	800	852	15
807480020.6UM	20.6mm	800	890	15



**3/8" DR. Universal Spark T wrench (joint type)**



<b>8073..U</b>		<i>l</i>		
Part no.	socket	mm	g	pc/box
807330016U	16mm	300	354	40
807330020.6U	20.6mm	300	392	40
807350016U	16mm	500	552	40
807350020.6U	20.6mm	500	590	40
807380016U	16mm	800	850	15
807380020.6U	20.6mm	800	888	15

**1/2" DR. Universal Spark T wrench (joint type)**

<b>8074..U</b>		<i>l</i>		
Part no.	socket	mm	g	pc/box
807430016U	16mm	300	646	30
807430020.6U	20.6mm	300	684	30
807450016U	16mm	500	936	30
807450020.6U	20.6mm	500	974	30
807480016U	16mm	800	1150	15
807480020.6U	20.6mm	800	1188	15





**Spark plug hole thread chaser**

<b>63001</b>		
Part no.	100/14.0/15.0/1.5'	140g

- \* Clean the thread in spark plug hole.
- \* Double end threads 14mm & 18mm.
- \* Applying company with 13/16" standard deep socket.





**Spark plug hole rethreader**

<b>63002</b>		
Part no.	100/13.5/14.5/1.5'	135g

- \* Double end threads 12mm & 14mm.
- \* Applying company with 13/16" standard deep socket.





**Spark plug hole thread chaser**

<b>63003</b>		
Part no.	100/10.0/11.0/1.5'	100g

- \* Double end threads 10mm & 12mm.
- \* Applying company with 13/16" standard deep socket.



**14mm Spark plug hole rethreader**

<b>63004</b>		
Part no.	250/14.5/15.5/1.25'	58g

- \* Use it to clean and restore the threads on 14mm spark plug hole prior installation of spark plug.
- \* Feature is extra-long neck for access to recessed spark plug cavities.
- \* Applying company with 3/8" drive or 5/8" standard socket.



**Oil filter strap wrench**

<b>619</b>		<i>l</i>	
Part no.	60/14.0/15.0/3'	150mm	233g

It can match with various tools for use 1/2" driver, pliers and screwdriver.



**Telescopic tubing cutter**

<b>65601</b>	size		
Part no.	3-32mm (1/8" to 1-1/4")	60/17.0/18.0/1.6'	283g



**Oil filter master pliers**

<b>639</b>	Filter		<i>l</i>	
Part no.	size	packing	mm	g
639230	53-118mm	40/18.4/19.4/2.2'	230	460



**Mini tubing cutter**

<b>65602</b>	size		
Part no.	3-22mm (1/8" to 7/8")	100/14.0/15.0/1.2'	140g



**Oil filter pliers**

<b>639</b>	Filter		<i>l</i>	
Part no.	size	packing	inch	g
639250	60-90mm	60/21.2/22.2/2'	10"	353
639300	85-115mm	60/22.7/23.7/2'	12"	378



**Exhaust pipe and tubing cutter**

<b>65603</b>		
Part no.	30/16.7/17.7/1.3'	556g

\* Cuts thin walled steel and copper tubing from f120mm to f75mm (3/4"-3").

\* Cuts quickly and easily.

\* Fitted with 7 cutting blades for fast, clean cutting.





**3-IN-1 Tubing bender**

<b>653</b>	Application		
Part no.	size	packing	g
65301	6;8;10mm	50/19.5/20.5/2'	390
65302	1/4";5/16";3/8"	50/19.5/20.5/2'	390



**Disc brake adjuster**

<b>62901</b>		
Part no.	20/19.4/20.4/1'	970g



**Piston ring compressor**

<b>620</b>	Capacity		<i>l</i>	
Part no.	mm	packing	inch	g
6203125	53-125	50/13.0/14.0/1.3'	3"	275
6203175	90-175	50/15.0/16.0/1.3'	3"	308
6204125	90-125	50/17.0/18.0/1.3'	4"	316
6204175	90-175	50/18.0/19.0/1.3'	4"	350
6206175	90-175	20/12.0/13.0/1.6'	6"	600



**Coil spring compressor**

<b>627</b>		<i>l</i>	
Part no.	packing	mm	g
627270	10/19.0/20.0/1'	270	1900
627370	10/20.5/21.5/1'	370	2050

\*Coil spring compressor made by forging and easy to use. Sold and packed in pair.



**Piston ring pliers**

<b>623</b>		<i>W</i>	<i>l</i>	
Part no.	packing	mm	mm	g
62301	50/15.0/16.0/2.8'	140	3"	250
62302	50/18.5/19.5/2.8'	190	3"	370

\*62302 is applied to truck.



**Coil spring compressor**

<b>62701</b>		
Part no.	12/17.0/18.0/0.5'	1416g

\* Use tool to remove and install automotive coil springs up to 5-5/8" OD. designed to grasp a maximum 3/4" wire diameter spring.

\* Compress can be used on straight or curved coil spring.

\* Forged alloy steel.



**Valve spring compressor**

**62101**



Part no.

8/25.0/26.0/1.7'

3125g

\* For large engines, most suitable for commercial vehicles and general garage use.

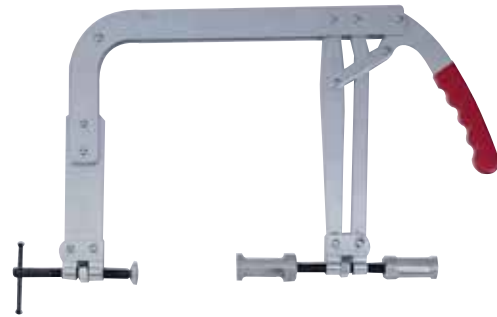

**Valve spring compressor**

**62104**



Part no.

6/15.0/16.0/1'

2450g

\* For multi-valve petrol and diesel engines, specially designed for difficult access and deep-seated multi-valve cylinder heads.



**Valve spring compressor**

**62102**



Part no.

10/16.5/17.5/1.2'

1650g

\* For overhead cam engines, specially designed for O.H.C. engines.



**Valve spring compressor**

**62106**



Part no.

24/16.8/17.8/2.1'

660g

\* Compresses overhead valve springs with rocker arm studs.  
\* This tool can be used with the head either on or off the engine.  
\* Jaws adjust to fit most overhead valve engines.  
\* Adjustable handle allows for clearance in tight areas.

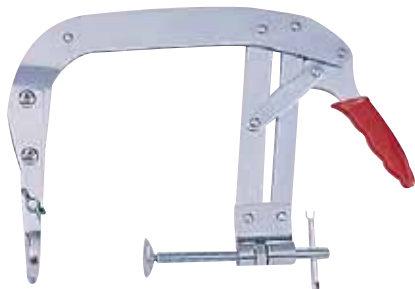

**Valve spring compressor**

**62103**





Part no.

10/11.6/12.6/0.5'

1160g

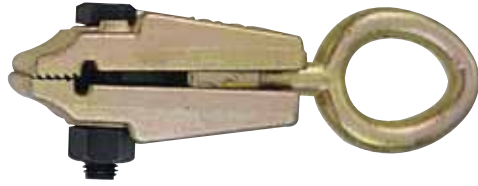

\* For small and medium engines.



Clamp		
<b>62501</b>		
Part no.	10/21.0/22.0/0.6'	2100g

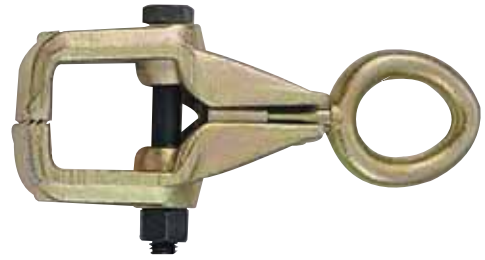

- \* Single direction action.
- \* Capacity: 5 tons



Clamp		
<b>62504</b>		
Part no.	10/18.0/19.0/0.88'	1800g



- \* Single direction action.
- \* The two side heights of jaw surface are not even, most suitable for narrow space application.
- \* Capacity: 3 ton



Clamp		
<b>62502</b>		
Part no.	10/21.0/22.0/0.6'	2100g

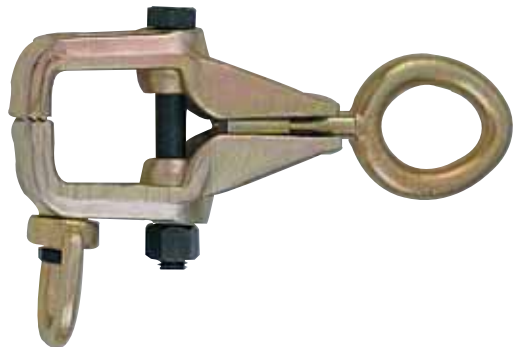

- \* Two direction action.
- \* Cross Capacity: 2 tons
- \* Longitudinal Capacity: 5 tons



Clamp		
<b>62505</b>		
Part no.	10/19.6/20.6/1.2'	1960g

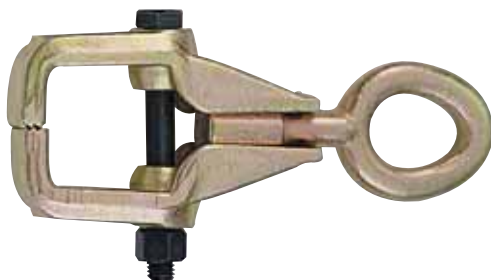

- \* Two direction action.
- \* The two side heights of jaw surface are not even, most suitable for narrow space application.
- \* Cross Capacity: 2 ton
- \* Longitudinal Capacity: 3 ton



Clamp		
<b>62503</b>		
Part no.	10/19.6/20.6/0.88'	1960g

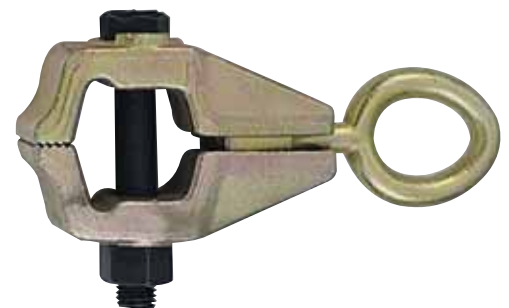

- \* Single direction action,
- \* Capacity: 3 tons



Clamp		
<b>62506</b>		
Part no.	6/17.8/18.8/1.5'	2960g



- \* Single direction action.
- \* Capacity: 5 ton



Clamp		
<b>62507</b>		
Part no.	5/15.2/16.2/1.1'	3500g



- \* Multi-direction action.
- \* The jaw surface can be extended about 3" (75mm).
- \* Capacity: 4 ton



Clamp		
<b>62510</b>		
Part no.	6/15.0/16.0/1.5'	2500g



- \* Single direction action.
- \* No need screw for locking.
- \* During operation it will lock as well as tightly.
- \* Capacity: 3 ton



Clamp		
<b>62508</b>		
Part no.	4/19.5/20.5/1.4'	4750g



- \* Multi-direction action.
- \* The jaw surface can be extended about 6" (150mm).
- \* Capacity: 4 ton



Clamp		
<b>62511</b>		
Part no.	6/13.9/14.9/1.5'	2330g

- \* Single direction action.
- \* The jaw surface is long 120mm, most suitable for thin sheet application.
- \* Capacity: 5 ton





Clamp		
<b>62509</b>		
Part no.	10/15.8/16.8/0.63'	1580g

- \* Single direction action.
- \* Long jaw mouth is most suitable for narrow space application.
- \* Capacity: 1 ton

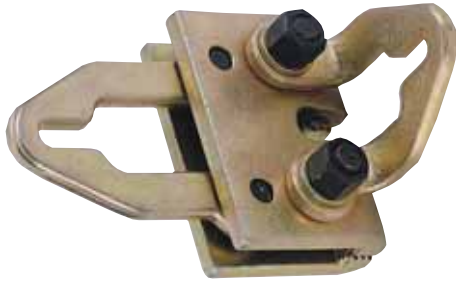





Clamp		
<b>62512</b>		
Part no.	6/16.3/17.3/1.3'	2710g



- \* Two direction action.
- \* The jaw surface is long 120mm, most suitable for thin sheet application.
- \* Cross Capacity: 3 ton
- \* Longitudinal Capacity: 5 ton



Clamp		
<b>62513</b>		
Part no.	6/19.6/20.6/1.5'	3260g



- \* Universal direction action.
- \* The jaw surface is long 120mm, most suitable for thin sheet application.
- \* Cross Capacity: 3 ton
- \* Longitudinal Capacity: 5 ton
- \* Multi-direction Capacity: 3 ton



Clamp		
<b>62514</b>		
Part no.	20/23.0/24.0/0.62'	1150g



- \* Applying for connecting and shortening the chain. (3/8" and 5/16" chain applicatory)
- \* Capacity: 6 ton

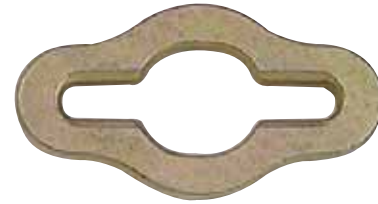

Clamp		
<b>62515</b>		
Part no.	10/11.5/12.5/0.32'	1150g

- \* Applying for two clamps are connected by a chain and make a two sides action. (3/8" and 5/16" chain applicatory)
- \* Capacity: 6 ton



Clamp		
<b>62516</b>		
Part no.	10/6.5/7.5/0.32'	650g

- \* Applying for connecting and shortening the chain. (3/8" and 5/16" chain applicatory)
- \* Capacity: 6 ton



SELF-TIGHTENING CLAMP		
<b>9M1601</b>		
Part no.	15/16.5/17.5/0.61'	1100g

- \* Minimum size, maximum capability for tight places.
- \* Responsive, spring-loaded, one-handed application for fast action pulls.
- \* Round wedge allows chain to be pulled free of twists.
- \* Aggressive cross-hatched tooth design.
- \* Capacity: 5 ton

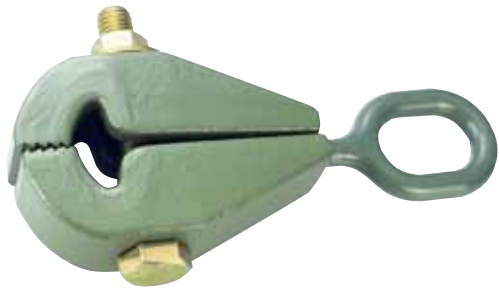

**SELF-TIGHTENING CLAMP**

<b>9M1602</b>		
Part no.	8/18.0/19.0/0.65'	2250g

- \* Self-Tightening clamp; grips tighter as it is pulled.
- \* Compact and lightweight for pulling from many places.
- \* Minimum of 1-1/2" reach-around for flanges, cowls, pinch welds, and lips.
- \* Butts against panels where only narrow bite available.
- \* 1-1/4"(31.8mm) jaws give added grip.
- \* Capacity: 6 ton



**SELF-TIGHTENING CLAMP**

<b>9M1603</b>		
Part no.	8/14.0/15.0/0.56'	1750g

- \* Self-tightening: The harder it's pulled, the tighter it grips.
- \* Heat-treated steel clamp is positioned on work with wedge forward and nut just finger tight.
- \* Easy to attach no special wrench needed.
- \* 2-1/4" (57.2mm) jaws
- \* Capacity: 6 ton

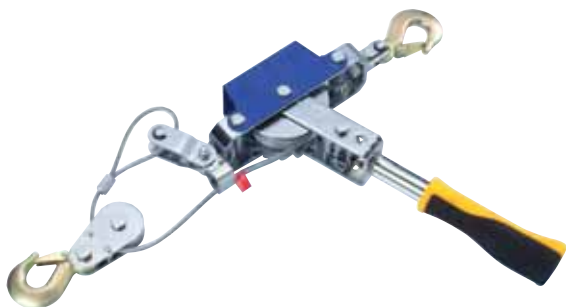

**1 ton Portable puller**

<b>88201</b>		
Part no.	6/20.4/21.9/2.0'	3400g



**Flat band hose clamp pliers**

<b>62518</b>		
Part no.	72/17.3/18.3/2.2'	240g

- \* Removes and installs new style flat band hose clamps. Jaws rotate to grip at any angle.



**CV Boot clamp pliers**

<b>62519</b>		
Part no.	72/23.0/24.0/2.1'	320g

- \* A sturdy tool, works on earless-type clamps including those found on GM inboard CV joint.



**CV Joint boot clamp pliers**

<b>62520</b>		
Part no.	48/17.8/18.8/1.5'	354g

- \* For ear type clamps, fits late model GM CV joint boots, also installs PERMA-QUICK type clamps quickly and easily use for filter, cooling system and vacuum lines.



**CV Dust boot clamp installer with cutter**

<b>62521</b>		
Part no.	36/20.0/21.0/1.8'	556g

- \* Use 1/2" socket wrench to wind and crimp by hand tool is easily disengaged from the band after the band is tightened.
- \* Cut off easily with built in cutting arm without any other tool.



**Ball joint separator**

<b>62801</b>		
Part no.	20/24.0/25.0/1.3'	1200g



**Ball joint separator**

<b>62802</b>		
Part no.	20/21.0/22.0/1'	1050g



**Ball joint separator**

<b>62805</b>		
Part no.	20/26.2/27.2/1.1'	1310g

- \* This universal tie rod end remover will work on most cars and light trucks.
- \* The necessary force needed to remove tie rod end is easily applied through the center pivot action.
- \* Fork opening: 20mm
- \* Reach: 20mm-50mm
- \* Suitable for: VW-AUDI, BMW, FIAT, FORD, MERCEDES,NISSAN, OPEL, PEUGEOT, RENAULT, ROVER,SAAB, TOYOTA, VOLVO.



**Ball Joint Extractor**

<b>62806</b>		
Part no.	12/18.2./18.7/0.9'	1620g

- \* For splitting track-rod ends, anti-roll bar mountings, wheel-hub ball joints, etc.
- \* Jaw open: 22mm
- \* 2-Stage, 50-80mm.



**Ball joint Extractor 23mm**

<b>6280723</b>		
Part no.	30/20.0/21.0/0.6'	667g

- \* For splitting track-rod ends, anti-roll bar mountings, ball joints, etc., especially in small space conditions.
- \* Audi VW, BMW, Ford, Mercedes (W170, W202, ETC), Opel/Vauxhall, etc.
- \* Jaws open: 23mm
- Jaws deep: 25mm



**Ball joint Extractor 28mm**

<b>6280728</b>		
Part no.	30/20.0/21.0/0.6'	667g

- \* For splitting track-rod ends, anti-roll bar mountings, ball joints, etc., especially in small space conditions.
- \* Audi A4, A6, A8, VW Passat and Mercedes W203 etc.
- \* Jaws open: 28mm
- Jaws deep: 25mm



**Universal ball joint puller**

<b>62808..</b>			
Part no.	Jaw open	Packing	g
6280817	17 mm	17/17.8/18.8/2.1'	1040
6280820	20 mm	20/23.3/24.3/2.1'	1165

- \* Special steel for removing the ball pivots on steering arms, steering tie rocks, steering knuckles etc.

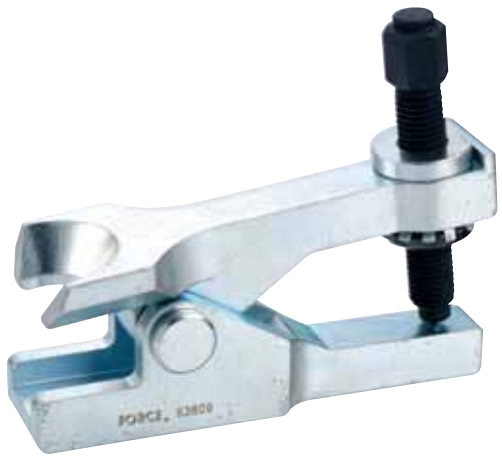

**Universal ball joint separator**

<b>62809</b>		
Part no.	10/29.0/30.0/2.1'	2900g

- \* Special steel for removing the ball pivots on steering arms, steering tie rocks, steering knuckles, etc.



**Ball joint extractor**

<b>628E...</b>			
Part no.	size	packing	g
628E18	18mm	60/19.8/20.8/1.2'	330
628E23	23mm	30/16.4/17.4/1'	545
628E29	29mm	20/18.2/19.2/0.9'	910
628E40	40mm	12/19.8/20.8/0.6'	1650
628E46	46mm	10/19.7/20.7/1.3'	1965

- \* For splitting track-rod ends, anti-roll bar mountings, ball joints etc.



**Ball joint separator**

<b>628</b>	Open		
Part no.	Size	Packing	mm g
628300	15/16"	25/19.0/20.0/0.3'	300 760
628400	21/32"	20/20.0/21.0/0.3'	400 1000





**Gear puller - 2 Jaw**

<b>65901</b>			
Part no.	size	packing	g
6590103	3"	40/17.6/18.6/0.92'	872
6590104	4"	20/15.5/16.5/0.75'	818
6590106	6"	10/16.5/17.5/1.2'	3586
6590108	8"	5/17.5/18.5/1.2'	3972
6590112	12"	3/21.0/22.0/1.6'	8000



**Hydraulic puller**

<b>65906..</b>					
Part no.	Capacity	Reach(mm)	Spread(mm)	Stroke(mm)	kg
6590604	4 tons	152-6"	150	55	4.5
6590606	6 tons	152-6"	200	82	4.9
6590606L	6 tons	190-8"	200	82	4.9
6590608	8 tons	190-8"	250	82	6.6
6590608L	8 tons	225-10"	250	82	6.6
6590615	15 tons	225-10"	280	82	8.0
6590615L	15 tons	300-12"	280	82	8.0



**Gear puller - 3 Jaw**

<b>65902</b>			
Part no.	size	packing	g
6590203	3"	30/16.5/17.5/0.9'	572
6590204	4"	20/17.0/18.0/0.8'	1072
6590206	6"	8/18.0/19.0/1'	2480
6590208	8"	4/18.0/19.0/1.35'	5456
6590212	12"	1/11.0/12.0/1'	11kg







**Hydraulic puller**

<b>6590630</b>					
Part no.	Capacity	Reach(mm)	Spread(mm)	Stroke(mm)	kg
6590630	30 tons	375-15"	540	110	31







**Hydraulic puller**

<b>65907..</b>					
Part no.	Capacity	Reach(mm)	Spread(mm)	Stroke(mm)	kg
6590710	10 tons	182-7"	280	82	5.6
6590710L	10 tons	220-9"	280	82	5.6
6590712	12 tons	220-9"	305	82	7.6
6590712L	12 tons	260-10"	305	82	7.6
6590720	20 tons	260-10"	356	82	10
6590720L	20 tons	300-12"	356	82	10







**Separate hydraulic puller**

<b>65908..</b>					
Part no.	Capacity	Reach(mm)	Spread(mm)	Stroke(mm)	kg
6590815	15 tons	230-9"	280	82	14
6590815L	15 tons	300-12"	280	82	14





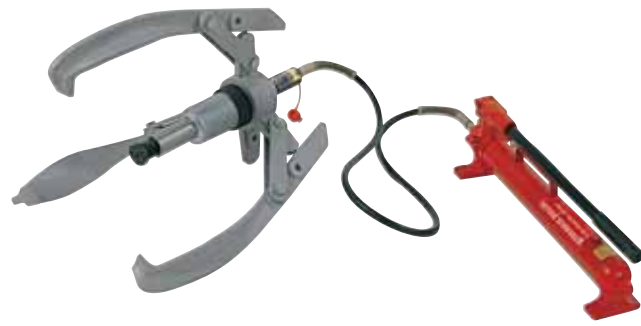

**Hydraulic puller**

<b>6590725</b>					
Part no.	Capacity	Reach(mm)	Spread(mm)	Stroke(mm)	kg
6590725	25 tons	300-12"	406	110	20
6590725L	25 tons	375-15"	406	110	20



**Separate hydraulic puller**

<b>6590825</b>					
Part no.	Capacity	Reach(mm)	Spread(mm)	Stroke(mm)	kg
6590825	25 tons	375-15"	540	110	30



**Hydraulic puller with hydraulic pump**

Part no.	Capacity	Reach(mm)	Spread(mm)	Stroke(mm)	kg
6590850	50 tons	405-16"	800	250	45
6590850L	50 tons	635-25"	1200	250	49



**Hydraulic puller**

Part no.	Capacity	Reach(mm)	Spread(mm)	Stroke(mm)	kg
6591106	6 tons	300-12"	95/235	82	6
6591108	8 tons	300-12"	95/235	82	7
6591110	10 tons	330-13"	95/235	82	6
6591112	12 tons	330-13"	95/235	82	7



**Hydraulic puller**

Part no.	Capacity	Reach(mm)	Spread(mm)	Stroke(mm)	kg
6591206	6 tons	170-7"	95/210	82	6.5
6591208	8 tons	220-9"	95/220	82	7.5
6591210	10 tons	190-8"	95/210	82	6.5
6591212	12 tons	240-10"	95/220	82	7.5



**Hydraulic puller**

Part no.	Capacity	Reach(mm)	Spread(mm)	Stroke(mm)	kg
6591306	6 tons	170-7"	95/210	82	8.5
6591308	8 tons	220-9"	95/220	82	9.5
6591310	10 tons	190-8"	95/210	82	8.5
6591312	12 tons	240-10"	95/220	82	9.5



**Puller accessory**

Part no.	Capacity	Reach(mm)	Spread(mm)	Stroke(mm)	kg
659C206	6 tons	170-7"	95/210	82	5.0
659C208	8 tons	220-9"	95/220	82	6.0
659C210	10 tons	190-8"	95/210	82	5.0
659C212	12 tons	240-10"	95/220	82	6.0



**Puller accessory**

Part no.	Capacity	Reach(mm)	Spread(mm)	Stroke(mm)	kg
659C306	6 tons	170-7"	95/210	82	8.0
659C308	8 tons	220-9"	95/220	82	9.0
659C310	10 tons	190-8"	95/210	82	8.0
659C312	12 tons	240-10"	95/220	82	9.0



659A01

659A02

659A03

**Puller accessory and straightener**

**659A...**

Part no.	Reach(mm)	Spread(mm)	Stroke(mm)	kg
659A01	150	100/410	82	9.5
659A02	205	100/410	82	9.0
659A03	205/150	100/410	82	10.0

\*This puller part converts 6590615 and 6590815 into a hydraulic straightening tool



**Gear puller - 2 Jaw**

**65909**

Part no.	Size	Length	Ton	kg
65909090	90	100	3	1.1
65909130	130	100	3	1.3
65909160	160	150	5	3.2
65909200	200	150	5	3.6
65909250	250	200	7.5	7.8
65909350	350	200	7.5	9.2
65909520	520	200	10	15.2
65909640	640	225	15	23.2



**Bearing puller**

**666A...**

Part no.	Capacity	g	packing
666A035	19mm - 35mm	375	40/15.0/16.0/1'
666A055	24mm - 55mm	375	40/15.0/16.0/1'
666A080	35mm - 80mm	600	20/12.0/13.0/1'



**Bearing Separator**

**666050**

Part no.	20/20.0/21.0/0.5'	1000g

\* SCM415, capacity 1-1/4" to 2-1/4" (30-50mm)  
 \* bolt(Diameter 9.5mm x 125mmL x 3/8" x24t)  
 \* hole(Diameter 8.2mm x 3/8" x 16t)



**Bearing Separator**

**666075**

Part no.	12/18.0/19.0/0.6'	1500g

\* SCM415, capacity 2-1/4" to 3-1/2" (50-75mm)  
 \* bolt(Diameter 12.7mm x 135mmL x 1/2" x20t)  
 \* hole(Diameter 8.2mm x 3/8" x 16t)



**Bearing Separator**

**666105**

Part no.	10/20.0/21.0/0.7'	2000g

\* SCM415, capacity 3" to 4-1/2" (75-105mm)  
 \* bolt(Diameter 16mm x 165mmL x 5/8" x 18t)  
 \* hole(Diameter 11.2mm x 1/2" x 12t)





**Bearing Separator**

**666150**



Part no.	4/30.0/31.0/1'	5000g
----------	----------------	-------

- \* SCM415, capacity 4" to 6" (105-150mm)
- \* bolt(Diameter 19mm x 260mmL x 3/4" x 16t)
- \* hole(Diameter 14.6mm x 5/8" x 11t)



**3pc Axle puller**

**66402**



Part no.	4/16.0/17.0/1.6'	4000g
----------	------------------	-------

- \* Central hole to screw hole 130mm
- \* Drop forged



**Bearing Separator**

**666140**



Part no.	4/30.0/31.0/1'	5000g
----------	----------------	-------

- \*Capacity 1.5" to 6" (35-140mm)



**3pc Axle puller**

**66403**



Part no.	18/22.0/23.0/2'	1220g
----------	-----------------	-------

- \* Central hole to screw hole 110mm
- \* Drop forged



**2pc Axle puller**

**66401**



Part no.	24/24.0/25.0/1.6'	1000g
----------	-------------------	-------

- \*Central hole to screw hole 130mm
- \*Drop forged



**3pc Axle puller**

**66404**



Part no.	4/17.0/18.0/1.3'	4250g
----------	------------------	-------

- \* Central hole to screw hole 110mm
- \* Drop forged



**Multi-function powerful suction cup (Aluminum)**

Part no.	Application	packing	Cap	kgs	g
<b>634..A</b>			Cap		
63401A	On flat object	20/11.4/12.4/1.5'	50	580	
63403A	Fixed 2 sucker	10/14.0/15.0/1.4'	80	1400	
63404A	Flexible 2 sucker	10/14.5/15.5/1.4'	80	1450	

- \* To pull up the plating notched part.
- \* To fix the windows while maintaining.
- \* To assemble the front and rear wind broken glasses.



**Multi-function powerful suction cup**

Part no.	Application	packing	Cap	kgs	g
<b>634</b>			Cap		
63401	On flat object	20/6.5/7.5/1.6'	50	325	
63404	Flexible 2 sucker	20/19.5/20.5/4'	80	975	

- \* To pull up the plating notched part.
- \* To fix the windows while maintaining.
- \* To assemble the front and rear wind broken glasses.



**Twist & shrinking hammer**

<b>62601</b>		
Part no.	40/17.8/18.8/2.7'	445g

\* Twist and shrinking hammer specially designed hammer surface profile has a good performance of expanding and making convex on sheet board.



**Curred tooth holder / file holder**

<b>65701</b>		
Part no.	20/15.7/16.7/2.1'	785g

Application: for 14" (350mm) flexible file adjustable frame



**Flexible file blade**

Part no.	teeth per inch	l	inch	g
<b>65714..</b>				
6571409	9	14"	310	
6571412	12	14"	350	



**4pc Star screwdriver set**

<b>2044</b>			
Part no.	Tip	60/9.0/10.0/2.5'	150g
716185 06B...09B	Content: 4-Star anti-slip screwdriver T6; T7; T8; T9 (blade 100mmL)		

**4pc Star screwdriver set**

<b>2044S</b>			
Part no.	Tip	60/9.0/10.0/2.5'	150g
716 06B...09B	Content: 4-Star anti-slip screwdriver T6; T7; T8; T9 (blade 60mmL)		

**4pc Star tamperproof screwdriver set**

<b>2044ST</b>			
Part no.	Tip	60/9.0/10.0/2.5'	150g
717 06B...09B	Content: 4-Star anti-slip tamperproof screwdriver T-6H; T-7H; T-8H; T-9H		



**6pc Star screwdriver set**

<b>2061</b>			
Part no.	Tip	30/12.5/13.5/1.7'	415g
716 10...30	Content: 6-Star screwdriver T10; T15; T20; T25; T27; T30		

**6pc Star tamperproof screwdriver set**

<b>2061T</b>			
Part no.	Tip	30/12.5/13.5/1.7'	415g
717 10...30	Content: 6-Star tamperproof screwdriver T-10H; T-15H; T-20H; T-25H; T-27H; T-30H		



**6pc Jeweler nut driver set**

<b>2064</b>			
Part no.	Tip	40/14.0/15.0/1.4'	350g
739 032...055 739 1.8...3.16	Content: 6-Hex jeweler nut drivers 3.2; 4.0; 5.0; 5.5 mm(75mmL) 1/8"; 3/16"(75mmL)		



**6pc Hex jeweler screwdriver set**

<b>2065</b>			
Part no.	Tip	40/12.0/13.0/1.4'	300g
734040015 734075 02...025 7340400.05 7340401.16 7340753.32	Content: 6-Hex jeweler screwdriver 1.5 mm (40mmL) 2.0; 2.5 mm (75mmL) 0.05" (40mmL) 1/16" (40mmL) 3/32 " (75mmL)		



**6pc Hex jeweler screwdriver set**

<b>2066</b>			
Part no.	Tip	40/12/13.0/1.4'	300g
	Content:		
	6-Hex jeweler screwdriver		
734040 009...015	0.9; 1.3; 1.5 mm (40mmL)		
734075 02...03	2.0; 2.5; 3.0 mm (75mmL)		



**7pc Insulated screwdriver set**

<b>20712</b>		
Part no.	10/7.5/8.5/1.1'	750g
	Content:	
711 1N...2N	2-Insulated phillips screwdriver PH.1 (80mmL); PH.2 (100mmL)	
713 03N...065N	4-Insulated slotted screwdriver 3 (100mmL); 4 (100mmL); 5.5 (125mmL); 6.5 (150mmL)	
2125P1	1-Induction circuit tester	

**8pc Screwdriver set**

<b>2084B</b>		
Part no.	10/6.8/7.8/1.1'	680g
	Content:	
	6-Anti-slip slotted screwdriver	
71303B	3 mm (75mmL)	
713035B	3.5 mm (100mmL)	
71304B	4 mm (100mmL)	
713055B	5.5 mm (125mmL)	
713065B	6.5 mm (150mmL)	
71308B	8 mm (175mmL)	
	2-Anti-slip phillips screwdriver	
7111B	PH.1 (80mmL)	
7112B	PH.2 (100mmL)	

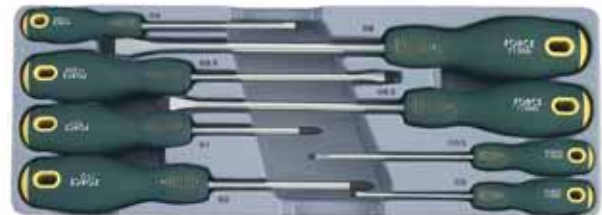



**8pc Screwdriver set**

<b>2084YC</b>		
Part no.	10/8.2/9.2/1.1'	815g
	Content:	
	6-Anti-slip slotted screwdriver	
71303	3 mm (75mmL)	
713035	3.5 mm (100mmL)	
71304	4 mm (100mmL)	
713055	5.5 mm (125mmL)	
713065	6.5 mm (150mmL)	
71308	8 mm (175mmL)	
	2-Anti-slip phillips screwdriver	
7111	PH.1 (80mmL)	
7112	PH.2 (100mmL)	

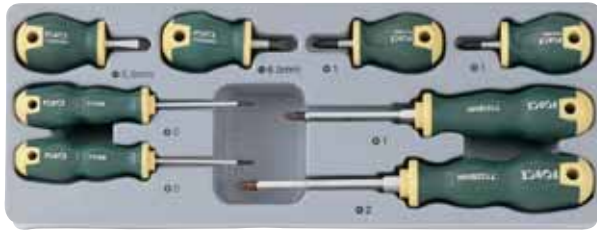





**8pc Screwdriver set**

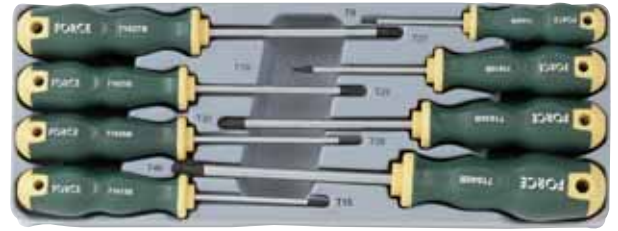

<b>2085B</b>		
Part no.	10/4.6/5.6/1.1'	460g
Content:	2-Anti-slip slotted screwdriver 2-Anti-slip phillips screwdriver 4-Anti-slip pozidriv screwdriver	
713055BS	5.5 mm (25mmL)	
713065BS	6.5 mm (25mmL)	
7110B	PH.0 (60mmL)	
7111BS	PH.1 (25mmL)	
7120B	PZ.0 (60mmL)	
7121BS	PZ.1 (25mmL)	
7121B	PZ.1 (80mmL)	
7122B	PZ.2 (100mmL)	



**8pc Star screwdriver set**



<b>2086B</b>			
Part no.	Tip	10/6.0/7.0/1.1'	600g
716 08B...40B	Content: 8-Star screwdriver T8; T10; T15; T20; T25; T27; T30; T40		

**8pc Star tamperproof screwdriver set**

<b>2086TB</b>			
Part no.	Tip	10/6.0/7.0/1.1'	600g
717 08B...40B	Content: 8-Star tamperproof screwdriver T-8H; T-10H; T-15H; T-20H; T-25H; T-27H; T-30H; T-40H		





**8pc Screwdriver set**



<b>2085YC</b>		
Part no.	10/6.2/7.2/1.1'	620g
Content:	2-Anti-slip slotted screwdriver 2-Anti-slip phillips screwdriver 4-Anti-slip pozidriv screwdriver	
713055S	5.5 mm (38mmL)	
713065S	6.5 mm (38mmL)	
7110	PH.0 (60mmL)	
7111S	PH.1 (38mmL)	
7120	PZ.0 (60mmL)	
7121S	PZ.1 (38mmL)	
7121	PZ.1 (80mmL)	
7122	PZ.2 (100mmL)	



**8pc Star screwdriver set**

<b>2086YC</b>			
Part no.	Tip	10/8.5/9.5/0.95'	845g
716 08...40	Content: 8-Star screwdriver T8; T10; T15; T20; T25; T27; T30; T40		

**8pc Star tamperproof screwdriver set**

<b>2086TYC</b>			
Part no.	Tip	10/8.4/9.4/0.95'	840g
717 08...40	Content: 8-Star tamperproof screwdriver T-8H; T-10H; T-15H; T-20H; T-25H; T-27H; T-30H; T-40H		



**8pc Jeweler screwdriver set**

<b>2087</b>		
Part no.	40/13.6/14.6/1.6'	340g
733075 02...04	Content: 5-Slotted jeweler screwdriver 2.0; 2.4; 3.0; 3.5; 4.0 (75mmL)	
731075 00...1	3-Phillips jeweler screwdriver PH.00; PH.0; PH.1 (75mmL)	



**8pc Star jeweler screwdriver set**

<b>2088</b>			
Part no.	Tip	40/13.6/14.6/1.6'	340g
736040 05...08	Content: 8-Star jeweler screwdriver T5; T6; T7; T8 mm(40mmL)		
736075 09...20	T9; T10; T15; T20 mm(75mmL)		

**8pc Star jeweler tamperproof screwdriver set**

<b>2088T</b>			
Part no.	Tip	40/13.6/14.6/1.6'	340g
737040 05...08	Content: 8-Star jeweler tamperproof screwdriver T-5H; T-6H; T-7H; T-8H (40mmL)		
737075 09...20	T-9H; T-10H; T-15H; T-20H (75mmL)		

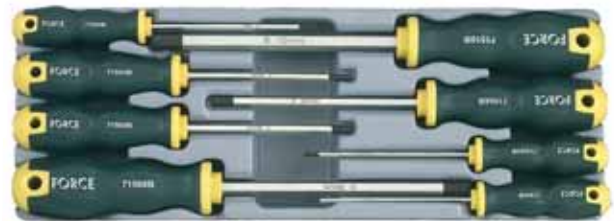

**8pc Hex screwdriver set**

<b>20810</b>			
Part no.	Tip	10/8.2/9.2/1.1'	820g
714 02B...10B	Content: 8-Hex screwdriver 2; 2.5; 3; 4; 5; 6; 8; 10 mm		

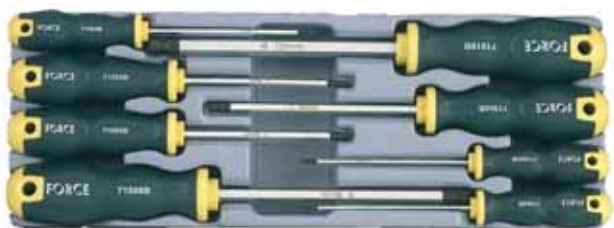

**8pc Hex ball screwdriver set**

<b>20810B</b>			
Part no.	Tip	10/8.2/9.2/1.1'	820g
715 02B...10B	Content: 8-Hex ball screwdriver 2; 2.5; 3; 4; 5; 6; 8; 10 mm		



**9pc Hex nut driver T handle set**

<b>2095</b>			
Part no.	Tip	6/11.3/12.3/1.8'	1750g
774300 05...13	Content: 9-Hex nut driver T handle 5; 6; 7; 8; 9; 10; 11; 12; 13mm (300mmL)		



**9pc Star nut driver T handle set**

<b>2096</b>			
Part no.	Tip	6/10.5/11.5/2.4'	530g
776 04...16	Content: 9-Star nut driver T handle E4; E5; E6; E7; E8; E10; E12; E14; E16(300mmL)		



**9pc Hex screwdriver T handle set(MM)**

<b>2097</b>			
Part no.	Tip	6/7.0/8.0/2.4'	1166g
724 02...10	Content: 9-Hex screwdriver T handle 2; 2.5; 3; 4; 5; 6; 7; 8; 10mm		

**9pc Hex screwdriver T handle set(SAE)**

<b>2097S</b>			
Part no.	Tip	6/7.0/8.0/2.4'	1166g
724 3.32...3.8	Content: 9-Hex screwdriver T handle 3/32"; 7/64"; 1/8"; 5/32"; 3/16"; 7/32"; 1/4"; 5/16"; 3/8"		

**9pc Hex ball point screwdriver T handle set**

<b>2097B</b>			
Part no.	Tip	6/7.0/8.0/2.4'	1166g
725 02...10	Content: 9-Hex ball point screwdriver T handle 2; 2.5; 3; 4; 5; 6; 7; 8; 10 mm		



**10pc Jeweler screwdriver set**

<b>2106</b>		
Part no.	20/14.0/15.0/1.8'	700g
733040 012...024	Content: 5-Slotted jeweler screwdriver 1.2; 1.5; 1.8; 2.0; 2.4 mm (40mmL)	
731040 000...0	3-Phillips jeweler screwdriver PH.000; PH.00; PH.0(40mmL)	
610110	1-Snipe nose pliers	
612140	1-Stocky model versatiliy	
2161-1	1-Tweezers	



**10pc Hammer screwdriver set**

<b>2108</b>		
Part no.	6/14.4/15.4/1.3'	2400g
713 055M...14M	Content: 6-Hammer slotted screwdriver 5.5(125mmL); 6.5(150mmL); 8(150mmL); 10(200mmL); 12(200mmL); 14(250mmL)	
711 1M...4M	4-Hammer Phillips screwdriver PH.1(80mmL); PH.2(100mmL); PH.3(150mmL); PH.4(200mmL)	





**10pc Hammer screwdriver set**

<b>2109</b>		
Part no.	6/14.4/15.4/1.3'	2400g
713 055M...14M	Content: 6-Hammer slotted screwdriver 5.5(125mmL); 6.5(150mmL); 8(150mmL); 10(200mmL); 12(200mmL); 14(250mmL)	
712 1M...4M	4-Hammer pozidriv screwdriver PZ.1(80mmL); PZ.2(100mmL); PZ.3(150mmL); PZ.4(200mmL)	



**12pc Insulated screwdriver set**

<b>2125</b>		
Part no.	6/7.0/8.0/1.3'	1140g
713 024N...8N	Content: 7-Insulated slotted screwdriver 2.4(75mmL); 3(100mmL); 3.5(100mmL); 4(100mmL); 5.5(125mmL); 6.5(150mmL); 8(175mmL)	
711 0N...3N	4-Insulated phillips screwdriver PH.0(60mmL); PH.1(80mmL); PH.2(100mmL); PH.3(150mmL)	
2125P1	1-Induction circuit tester	



**11pc Star screwdriver set**

<b>2119</b>			
Part no.	Tip	20/13.0/14.0/1.4'	650g
716 06...40	Content: 11-Star screwdriver T6; T7; T8; T9; T10; T15; T20; T25; T27; T30; T40		

**11pc Star tamperproof screwdriver set**

<b>2119T</b>			
Part no.	Tip	20/13.0/14.0/1.4'	650g
717 06...40	Content: 11-Star tamperproof screwdriver T-6H; T-7H; T-8H; T-9H; T-10H; T-15H; T-20H; T-25H; T-27H; T-30H; T-40H		



**12pc Insulated screwdriver set**

<b>2126</b>		
Part no.	6/7.0/8.0/1.3'	1140g
713 024N...8N	Content: 7-Insulated slotted screwdriver 2.4(75mmL); 3(100mmL); 3.5(100mmL); 4(100mmL); 5.5(125mmL); 6.5(150mmL); 8(175mmL)	
712 0N...3N	4-Insulated pozidriv screwdriver PZ.0(60mmL); PZ.1(80mmL); PZ.2(100mmL); PZ.3(150mmL)	
2125P1	1-Induction circuit tester	





**13pc Hex nut driver set**

<b>2134</b>			
Part no.	Tip	6/11.0/12.0/1.3'	1833g
744250 04...14	Content: 13-Hex nut driver 4; 4.5; 5; 5.5; 6; 7; 8; 9; 10; 11; 12; 13; 14 mm(250mmL)		



**13pc Star screwdriver set**

<b>2137YC</b>			
Part no.	Tip	10/10.5/11.5/1.8'	1050g
716 05...45	Content: 13-Star screwdriver T5; T6; T7; T8; T9; T10; T15; T20; T25; T27; T30; T40; T45		

**13pc Star tamperproof screwdriver set**

<b>2137TYC</b>			
Part no.	Tip	10/10.5/11.5/1.8'	1050g
71605 717 06...45	Content: 1-Star screwdriver T5 12-Star tamperproof screwdriver T-6H; T-7H; T-8H; T-9H; T-10H; T-15H; T-20H; T-25H; T-27H; T-30H; T-40H; T-45H		



**13pc Star screwdriver set**

<b>2137</b>			
Part no.	Tip	6/7.3/8.3/1.3'	1217g
716 05B...45B	Content: 13-Star screwdriver T5; T6; T7; T8; T9; T10; T15; T20; T25; T27; T30; T40; T45		

**13pc Star tamperproof screwdriver set**

<b>2137T</b>			
Part no.	Tip	6/7.3/8.3/1.3'	1217g
717 05B...45B	Content: 13-Star tamperproof screwdriver T-5H; T-6H; T-7H; T-8H; T-9H; T-10H; T-15H; T-20H; T-25H; T-27H; T-30H; T-40H; T-45H		



**14pc Star screwdriver T handle set**

<b>2141</b>			
Part no.	Tip	6/8.5/9.5/2.4'	1415g
726 06...55	Content: 14-Star screwdriver T handle T6; T7; T8; T9; T10; T15; T20; T25; T27; T30; T40; T45; T50; T55		

**14pc Star tamperproof screwdriver T handle set**

<b>2141T</b>			
Part no.	Tip	6/8.5/9.5/2.4'	1415g
727 06...55	Content: 14-Star tamperproof screwdriver T handle T-6H; T-7H; T-8H; T-9H; T-10H; T-15H; T-20H; T-25H; T-27H; T-30H; T-40H; T-45H; T-50H; T-55H		

**14pc Screwdriver set**

<b>2142YC</b>		
Part no.	10/10.5/11.5/1.8'	1490g
713 03...08	Content: 6-Slotted screwdriver 3mm(75mmL); 3.5mm(100mmL); 4mm(100mmL); 5.5mm(125mmL); 6.5mm(150mmL); 8mm(175mmL)	
713 055S...065S	2-Slotted stubby screwdriver 5.5mm(38mmL); 6.5mm(38mmL)	
711 0...3	4-Phillips screwdriver PH.0(60mmL); PH.1(80mmL); PH.2(100mmL); PH.3(150mmL)	
711 1S...2S	2-Phillips stubby screwdriver PH.1(38mmL); PH.2(38mmL)	

**14pc Screwdriver set**

<b>2142</b>		
Part no.	6/8.4/9.4/1.3'	1490g
713 03B...08B	Content: 6-Slotted screwdriver 3mm(75mmL); 3.5mm(100mmL); 4mm(100mmL); 5.5mm(125mmL); 6.5mm(150mmL); 8mm(175mmL)	
713 055BS...065BS	2-Slotted stubby screwdriver 5.5mm(25mmL); 6.5mm(25mmL)	
711 0B...3B	4-Phillips screwdriver PH.0(60mmL); PH.1(80mmL); PH.2(100mmL); PH.3(150mmL)	
711 1BS...2BS	2-Phillips stubby screwdriver PH.1(25mmL); PH.2(25mmL)	

**14pc Screwdriver set**

<b>2143</b>		
Part no.	6/8.4/9.4/1.3'	1490g
713 03B...08B	Content: 6-Slotted screwdriver 3mm(75mmL); 3.5mm(100mmL); 4mm(100mmL); 5.5mm(125mmL); 6.5mm(150mmL); 8mm(175mmL)	
713 055BS...065BS	2-Slotted stubby screwdriver 5.5mm(25mmL); 6.5mm(25mmL)	
712 0B...3B	4-Pozidriv screwdriver PZ.0(60mmL); PZ.1(80mmL); PZ.2 (100mmL); PZ.3(150mmL)	
712 1BS...2BS	2-Pozidriv stubby screwdriver PZ.1(25mmL); PZ.2(25mmL)	



**16pc Jeweler screwdriver set**

<b>2161</b>		
Part no.	20/14.5/15.5/1.8'	725g
	Content:	
733040 01...024	6-Slotted jeweler screwdriver 1.0; 1.2; 1.5; 1.8; 2.0; 2.4 mm(40mmL)	
731040 000...00	2-Phillips jeweler screwdriver PH.000; PH.00(40mmL)	
734040 009...015	3-Hex jeweler screwdriver 0.9; 1.3; 1.5 mm(40mmL)	
610110	1-Snipe nose pliers	
612140	1-Stocky model versatiliy	
2161-1	1-Tweezer	
2161-2	1-Scissor	
2161-3	1-Scalpel(with 6 blades)	



**20pc Jeweler screwdriver set**

<b>2204</b>		
Part no.	40/11.8/12.8/1.5'	295g
	Content:	
73904DS	1- 4mm inhex screwdriver(50mmL)	
11128 00...0	2- 4mm phillips bit(28mmL) PH.00; PH.0	
11228 00...0	2- 4mm pozidriv bit(28mmL) PZ.00; PZ.0	
11328 02...04	4- 4mm slotted bit(28mmL) 2.0; 2.5; 3.0; 4.0 mm	
11428 015...025	3- 4mm hex bit(28mmL) 1.5; 2.0; 2.5 mm	
11528 015...025	3- 4mm hex ball bit(28mmL) 1.5; 2.0; 2.5 mm	
11628 06...10	5- 4mm star bit(28mmL) T6; T7; T8; T9; T10	





**26pc Jeweler screwdriver set**

<b>2261</b>		
Part no.	40/13.4/14.4/1.5'	335g
	Content:	
73904DS	1- 4mm inhex screwdriver(50mmL)	
11128 00...0	2- 4mm phillips bit(28mmL) PH.00; PH.0	
11228 00...0	2- 4mm pozidriv bit (28mmL) PZ.00; PZ.0	
11328 02...04	4- 4mm slotted bit(28mmL) 2.0; 2.5; 3.0; 4.0 mm	
11428 015...025	3- 4mm hex bit(28mmL) 1.5; 2.0; 2.5 mm	
11528 015...025	3- 4mm hex ball bit(28mmL) 1.5; 2.0; 2.5 mm	
11628 06...10	5- 4mm star bit(28mmL) T6; T7; T8; T9; T10	
52422 032...07	5- 1/4" socket(22mmL) 3.2; 4.0; 5.0; 5.5; 7.0 mm	
8291225	1- Bit adaptor(25mmL) 4mmHex-1/4" Sq.	











**75pc Screwdriver set**

<b>2751</b>		
Part no.	2/16.4/17.4/1.4'	8200g
711 0B...3B	Content: 3-Phillips screwdriver PH.0(60mmL); PH.1(80mmL); PH.3(150mmL)	
711 1BS...2BS	2-Stubby phillips screwdriver PH.1(25mmL); PH.2(25mmL)	
713 03B...08B	6-Slotted screwdriver 3mm(75mmL); 3.5mm(100mmL); 4mm(100mmL); 5.5mm(125mmL); 6.5mm(150mmL); 8mm(175mmL)	
713 055BS... 065BS	2-Stubby slotted screwdriver 5.5mm(25mmL); 6.5mm(25mmL)	
7112B	* <b>Above each size 5pcs</b> 10-Phillips screwdriver PH.2(100mmL)	

**75pc Star screwdriver set**



<b>2753</b>			
Part no.	Tip	2/16.4/17.4/1.4'	8200g
716 05B...45B	Content: 11-Star screwdriver T5; T6; T7; T8; T9; T20; T25; T27; T30; T40; T45		
716 10B...15B	* <b>Above each size 5pcs</b> 2-Star screwdriver T10; T15 * <b>Above each size 10pcs</b>		

**75pc Star tamperproof screwdriver set**

<b>2753T</b>			
Part no.	Tip	2/16.4/17.4/1.4'	8200g
717 05B...45B	Content: 11-Star tamperproof screwdriver T-5H; T-6H; T-7H; T-8H; T-9H; T-20H; T-25H; T-27H; T-30H; T-40H; T-45H		
717 10B...15B	* <b>Above each size 5pcs</b> 2-Star tamperproof screwdriver T-10H; T-15H * <b>Above each size 10pcs</b>		



**75pc Screwdriver set**

<b>2752</b>		
Part no.	2/16.4/17.4/1.4'	8200g
712 0B...3B	Content: 3-Pozidriv screwdriver PZ.0(60mmL); PZ.1(80mmL); PZ.3(150mmL)	
712 1BS...2BS	2-Stubby pozidriv screwdriver PZ.1(25mmL); PZ.2(25mmL)	
713 03B...08B	6-Slotted screwdriver 3mm(75mmL); 3.5mm(100mmL); 4mm(100mmL); 5.5mm(125mmL); 6.5mm(150mmL); 8mm(175mmL)	
713 055BS... 065BS	2-Stubby slotted screwdriver 5.5mm(25mmL); 6.5mm(25mmL)	
7122B	* <b>Above each size 5pcs</b> 10-Pozidriv screwdriver PZ.2(100mmL)	





**3pc Hinged socket wrench set**

<b>5033</b>			
Part no.	Tip	6/15.0/16.0/0.9'	2500g
752 2022...2427	Content: 3-Hinged socket wrench 20x22; 21x23; 24x27 mm		



**4pc Star double gear flat wrench set**

<b>K50411</b>			
Part no.	Tip	12/15.0/16.0/1.1'	878g
828 0608...2024	Content: 4-Star double gear flat wrench E6xE8; E10xE12; E14xE18; E20xE24		



**4pc Star wrench set**

<b>5041</b>			
Part no.	Tip	60/20.5/21.5/1.7'	342g
756 0608...2024	Content: 4-Star wrench E6xE8; E10xE12; E14xE18; E20xE24		



**5pc Combination wrench set**

<b>5052</b>		
Part no.	6/15.6/16.6/1'	2600g
755 26...32	Content: 5-Combination wrench 26; 27; 28; 30; 32 mm	



**4pc 75... offset ring wrench set**

<b>5044</b>			
Part no.	Tip	6/13.7/14.7/1'	2280g
759 2326...3032	Content: 4-75... Offset ring wrench 23x26; 24x27; 25x28; 30x32 mm		



**6pc Star wrench set**

<b>5062</b>			
Part no.	Tip	30/15.5/16.5/1.3'	515g
756 0608...2024	Content: 6-Star wrench E6xE8; E7xE11; E10xE12; E14xE18; E16xE22; E20xE24		

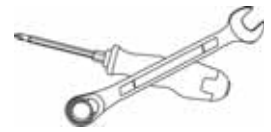

**6pc Extra long flat ring wrench set**

<b>50622</b>			
Part no.	Tip	12/24.5/25.5/1.2'	1916g
760 1012...1719	Content: 6-Extra long flat ring wrench 10x12; 12x14; 13x15; 14x17; 16x18; 17x19 mm		



**6pc Double gear flat wrench set**

<b>K50625</b>			
Part no.	Tip	6/15.5/16.5/0.8'	515g
827M 0809...1719	Content: 6-Double gear flat wrench 8x9; 10x11; 12x13; 14x15; 16x18; 17x19		



**6pc Double gear flat long wrench set**

<b>50623</b>			
Part no.	Tip	12/20.9/21.9/1.2'	1614g
827 1012...1719	Content: 6-Double gear flat long wrench 10x12; 12x14; 13x15; 14x17; 16x18; 17x19 mm		



**6pc Star key set**

<b>5063</b>			
Part no.	Tip	48/24.0/25.0/0.9'	500g
766 40...60	Content: 6-Star key T40; T45; T47; T50; T55; T60		



**6pc Star tamperproof key set**

<b>5063T</b>			
Part no.	Tip	48/24.0/25.0/0.9'	500g
766 40...60	Content: 6-Star tamperproof key T-40H; T-45H; T-47H; T-50H; T-55H; T-60H		

**6pc Midget 45... offset ring wrench set**

<b>50624</b>			
Part no.	Tip	30/15.5/16.5/1.3'	515g
758S 0809...1819	Content: 6-Midget 45... offset ring wrench 8x9; 10x11; 12x13; 14x15; 16x17; 18x19 mm		



**6pc Star 75... offset wrench set**

<b>5065</b>			
Part no.	Tip	20/13.8/14.8/1.3'	690g
756 0608A... 2024A	Content: 6-Star 75... offset wrench E6xE8; E7xE11; E10xE12; E14xE18; E16xE22; E20xE24		



**6pc Double open end wrench set (MM)**

<b>5067</b>		
Part no.	20/14.5/15.5/0.8'	725g
754 0809...2123	Content: 6-Double open end wrench 8x9; 10x12; 12x14; 14x17; 17x19; 21x23 mm	



**6pc Flare nut wrench set (MM)**

<b>5066</b>		
Part no.	30/18.3/19.3/1.3'	610g
751 0810...1719	Content: 6-Flare nut wrench 8x10; 10x11; 10x12; 11x13; 12x14; 17x19 mm	

**6pc Double open end wrench set (SAE)**

<b>5067S</b>		
Part no.	20/14.5/15.5/0.8'	725g
754 0810S... 2122S	Content: 6-Double open end wrench 5/16"x3/8"; 3/8"x7/16"; 1/2"x9/16"; 5/8"x11/16"; 11/16"x3/4"; 13/16"x7/8"	

**6pc Flare nut wrench set (SAE)**

<b>5066S</b>		
Part no.	30/18.3/19.3/1.3'	610g
751 0810S... 1719S	Content: 6-Flare nut wrench 5/16"x3/8"; 3/8"x7/16"; 7/16"x1/2"; 1/2"x9/16"; 5/8"x3/4"; 11/16"x3/4"	



**6pc Combination wrench set (MM)**

<b>5068</b>		
Part no.	20/14.5/15.5/0.8'	725g
755 10...21	Content: 6-Combination wrench 10; 12; 14; 17; 19; 21 mm	

**6pc Combination wrench set (SAE)**

<b>5068S</b>		
Part no.	20/14.5/15.5/0.8'	725g
755 3.8...11.16	Content: 6-Combination wrench 3/8"; 7/16"; 1/2"; 9/16"; 5/8"; 11/16"	



**6pc 45... Offset ring wrench set (MM)**

<b>5069</b>			
Part no.	Tip	10/17.0/18.0/0.8'	1580g
758 1012... 2326	Content: 6-45... Offset ring wrench 10x12; 12x14; 14x17; 17x19; 19x21; 23x26 mm		

**6pc 45... Offset ring wrench set (SAE)**

<b>5069S</b>			
Part no.	Tip	10/17.0/18.0/0.8'	1580g
758 1011S... 2425S	Content: 6-45... Offset ring wrench 3/8"x7/16"; 1/2"x9/16"; 9/16"x5/8"; 11/16"x3/4"; 3/4"x7/8"; 15/16"x1"		



**6pc 75... Offset ring wrench set (MM)**

<b>50610</b>			
Part no.	Tip	10/15.5/16.5/0.9'	1650g
759 1012... 2326	Content: 6-75... Offset ring wrench 10x12; 12x14; 14x17; 17x19; 19x21; 23x26 mm		

**6pc 75... Offset ring wrench set (SAE)**

<b>50610S</b>			
Part no.	Tip	10/15.5/16.5/0.9'	1650g
759 1011S... 2425S	Content: 6-75... Offset ring wrench 3/8"x7/16"; 1/2"x9/16"; 5/8"x11/16"; 3/4"x7/8"; 13/16"x7/8"; 15/16"x1"		



**6pc Hinged socket wrench set (SAE)**

<b>50616S</b>			
Part no.	Tip	6/19.0/20.0/0.9'	3170g
752 1011S... 2425S	Content: 6-Hinged socket wrench 3/8"x7/16"; 1/2"x9/16"; 5/8"x11/16"; 3/4"x7/8"; 13/16"x7/8"; 15/16"x1"		



**6pc 15... Offset star ratchet ring wrench set**

<b>50617</b>			
Part no.	Tip	6/11.1/12.1/0.9'	1850g
826 0607... 2224	Content: 6-15... Offset star ratchet ring wrench E6xE7; E8xE10; E11xE12; E14xE16; E18xE20; E22xE24		





**7pc Star key set**

<b>5071</b>			
Part no.	Tip	80/11.0/12.0/0.8'	138g
766 10...40	Content: 7-Star key T10; T15; T20; T25; T27; T30; T40		

**7pc Star tamperproof key set**

<b>5071T</b>			
Part no.	Tip	80/11.0/12.0/0.8'	138g
767 10...40	Content: 7-Star tamperproof key T-10H; T-15H; T-20H; T-25H; T-27H; T-30H; T-40H		



**7pc Hex key set (MM)**

<b>5072</b>			
Part no.	Tip	60/15.5/16.5/1.1'	258g
764 025...10	Content: 7-Hex key 2.5; 3; 4; 5; 6; 8; 10 mm		

**7pc Hex key set (SAE)**

<b>5072S</b>			
Part no.	Tip	60/15.5/16.5/1.1'	258g
764 3.32...3.8	Content: 7-Hex key 3/32"; 1/8"; 5/32"; 3/16"; 1/4"; 5/16"; 3/8"		



**7pc Hex key set (Folding)**

<b>5072F</b>			
Part no.	Tip	40/17.0/18.0/1.2'	425g
5072F	Content: 7-Hex key (Folding) 2.5; 3; 4; 5; 6; 8; 10 mm		



**7pc Hex ball point key set (Folding)**

<b>5072BF</b>			
Part no.	Tip	40/17.0/18.0/1.2'	425g
5072BF	Content: 7-Hex ball point key (Folding) 2.5; 3; 4; 5; 6; 8; 10 mm		



**7pc Hex long key set (MM)**

<b>5072L</b>			
Part no.	Tip	50/17.6/18.6/1'	368g
764 025L...10L	Content: 7-Hex long key 2.5; 3; 4; 5; 6; 8; 10 mm		

**7pc Hex long key set (SAE)**

<b>5072LS</b>			
Part no.	Tip	50/17.6/18.6/1'	368g
764 3.32L...3.8L	Content: 7-Hex long key 3/32"; 1/8"; 5/32"; 3/16"; 1/4"; 5/16"; 3/8"		



**7pc Hex extra long key set (MM)**

<b>5072XL</b>			
Part no.	Tip	40/17.5/18.5/1.1'	450g
764 025XL... 10XL	Content: 7-Hex extra long key 2.5; 3; 4; 5; 6; 8; 10 mm		

**7pc Hex extra key set (SAE)**

<b>5072XLS</b>			
Part no.	Tip	40/17.5/18.5/1.1'	450g
764 3.32XL... 3.8XL	Content: 7-Hex extra long key 3/32"; 1/8"; 5/32"; 3/16"; 1/4"; 5/16"; 3/8"		



**7pc Hex ball point long key set (MM)**

<b>5072LB</b>				
Part no.	Tip	Tip	50/17.6/18.6/1'	368g
765 025L...10L	Content: 7-Hex ball point long key 2.5; 3; 4; 5; 6; 8; 10 mm			

**7pc Hex ball point long key set (SAE)**

<b>5072LBS</b>				
Part no.	Tip	Tip	50/17.6/18.6/1'	368g
765 3.32L... 3.8L	Content: 7-Hex ball point long key 3/32"; 1/8"; 5/32"; 3/16"; 1/4"; 5/16"; 3/8"			



**7pc Hex ball point extra long key set (MM)**

<b>5072XLB</b>				
Part no.	Tip	Tip	40/17.5/18.5/1.1'	450g
765 025XL... 10XL	Content: 7-Hex ball point extra long key 2.5; 3; 4; 5; 6; 8; 10 mm			

**7pc Hex ball point extra long key set (SAE)**

<b>5072XLB</b>				
Part no.	Tip	Tip	40/17.5/18.5/1.1'	450g
765 3.32XL... 3.8XL	Content: 7-Hex ball point extra long key 3/32"; 1/8"; 5/32"; 3/16"; 1/4"; 5/16"; 3/8"			



**7pc Hinged socket wrench set**

<b>5074</b>			
Part no.	Tip	6/13.0/14.0/0.9'	2165g
752 0607... 1819	Content: 7-Hinged socket wrench 6x7; 8x9; 10x11; 12x13; 14x15; 16x17; 18x19 mm		



**7pc Star hinged socket wrench set**

<b>5075</b>			
Part no.	Tip	6/13.0/14.0/0.9'	2165g
756 0405F... 2224F	Content: 7-Star hinged socket wrench E4xE5; E6xE7; E8xE10; E11xE12; E14xE16; E18xE20; E22xE24		



**7pc Hex key set (MM)**

<b>5076</b>			
Part no.	Tip	100/10/11.0/1'	100g
764 015...06	Content: 7-Hex key 1.5; 2; 2.5; 3; 4; 5; 6 mm		

**7pc Hex key set (SAE)**

<b>5076S</b>			
Part no.	Tip	100/10.0/11.0/1'	100g
764 1.16...1.4	Content: 7-Hex key 1/16"; 5/64"; 3/32"; 1/8"; 5/32"; 3/16"; 1/4"		



**7pc Hex key set (Folding)**

<b>5076F</b>			
Part no.	Tip	100/15.0/16.0/1.6'	150g
5076F	Content: 7-Hex key (Folding) 1.5; 2; 2.5; 3; 4; 5; 6mm		



**7pc Combination wrench set (MM)**

<b>5077</b>		
Part no.	20/15.6/16.6/0.88'	780g
755 10...21	Content: 7-Combination wrench 10; 12; 13; 14; 17; 19; 21 mm	

**7pc Combination wrench set (SAE)**

<b>5077S</b>		
Part no.	20/15.6/16.6/0.88'	780g
755 3.8...3.4	Content: 7-Combination wrench 3/8"; 7/16"; 1/2"; 9/16"; 5/8"; 11/16"; 3/4"	



**7pc 75... Offset ring wrench set (SAE)**

<b>5079S</b>			
Part no.	Tip	6/13.6/14.6/0.9'	2270g
759 0608S... 2425S	Content: 7-75... Offset ring wrench 1/4"x5/16"; 3/8"x7/16"; 1/2"x9/16"; 5/8"x11/16"; 3/4"x7/8"; 13/16"x7/8"; 15/16"x1"		



**7pc Flare nut wrench set (SAE)**

<b>50710S</b>		
Part no.	6/10.0/11.0/0.9'	1670g
751 0810S... 1922S	Content: 7-Flare nut wrench 5/16"x3/8"; 3/8"x7/16"; 7/16"x1/2"; 1/2"x9/16"; 5/8"x3/4"; 11/16"x3/4"; 3/4"x7/8"	



**7pc Hex extra long key set (MM)**

<b>50711XL</b>			
Part no.	Tip	42/8.0/9.0/1.6'	190g
764 015XL... 06XL	Content: 7-Hex key 1.5; 2; 2.5; 3; 4; 5; 6 mm		

**7pc Hex extra long key set (SAE)**

<b>50711XLS</b>			
Part no.	Tip	42/8.0/9.0/1.6'	190g
764 1.16XL... 1.4XL	Content: 7-Hex key 1/16"; 5/64"; 3/32"; 1/8"; 5/32"; 3/16"; 1/4"		



**7pc Hex ball point extra long key set (MM)**

<b>50711XLB</b>				
Part no.	Tip	Tip	42/8.0/9.0/1.6'	190g
765 015XL... 06XL	Content: 7-Hex ball point extra long key 1.5; 2; 2.5; 3; 4; 5; 6 mm			

**7pc Hex ball point extra long key set (SAE)**

<b>50711XLBS</b>				
Part no.	Tip	Tip	42/8.0/9.0/1.6'	190g
765 1.16XL... 1.4XL	Content: 7-Hex ball point extra long key 1/16"; 5/64"; 3/32"; 1/8"; 5/32"; 3/16"; 1/4"			





7pc Midget 45... offset ring wrench			
<b>50714</b>			
Part no.	20/15.5/16.5/1.1'	775g	
758S 0809... 1719	Content: 7-Midget 45... offset ring wrench 8x9; 10x12; 12x14; 14x15; 14x17; 16x18; 17x19		



8pc Flare nut wrench set			
<b>5082</b>			
Part no.	6/15.3/16.3/0.9'	2550g	
751 0810...3032	Content: 8-Flare nut wrench 8x10; 11x13; 12x14; 16x18; 17x19; 19x22; 24x27; 30x32 mm		



8pc 75... Offset ring wrench set (MM)			
<b>5081</b>			
Part no.	Tip 6/13.0/14.0/0.9'	2166g	
759 0607... 2123	Content: 8-75... Offset ring wrench 6x7; 8x9; 10x11; 12x13; 14x15; 16x17; 18x19; 21x23 mm		



8pc Star key set (Folding)			
<b>5083F</b>			
Part no.	Tip 40/13.5/14.5/1.2'	338g	
5083F	Content: 8-Star key (Folding) T9; T10; T15; T20; T25; T27; T30; T40		

8pc 75... Offset ring wrench set (SAE)			
<b>5081S</b>			
Part no.	Tip 6/13.0/14.0/0.9'	2166g	
759 0608S... 2425S	Content: 8-75... Offset ring wrench 1/4"x5/16"; 3/8"x7/16"; 1/2"x9/16"; 5/8"x11/16"; 5/8"x3/4"; 3/4"x7/8"; 13/16"x7/8"; 15/16"x1"		

8pc Star tamperproof key set (Folding)			
<b>5083TF</b>			
Part no.	Tip 40/13.5/14.5/1.2'	338g	
5083TF	Content: 8-Star tamperproof key (Folding) T-9H; T-10H; T-15H; T-20H; T-25H; T-27H; T-30H; T-40H		



**8pc Double open end wrench set**

<b>5084</b>		
Part no.	10/9.5/10.5/0.88'	1300g
754 0607... 2022	Content: 8-Double open end wrench 6x7; 8x9; 10x11; 12x13; 14x15; 16x17; 18x19; 20x22 mm	



**8pc Combination wrench set (MM)**

<b>5086</b>		
Part no.	20/17.3/18.3/1.1'	862g
755 10...22	Content: 8-Combination wrench 10; 11; 12; 13; 14; 17; 19; 22 mm	

**8pc Combination wrench set (SAE)**

<b>5086S</b>		
Part no.	20/17.3/18.3/1.1'	862g
755 3.8...13.16	Content: 8-Combination wrench 3/8"; 7/16"; 1/2"; 9/16"; 5/8"; 11/16"; 3/4"; 13/16"	



**8pc 45... Offset ring wrench set (MM)**

<b>5085</b>			
Part no.	Tip	6/10.3/11.3/0.9'	1720g
758 0809... 2224	Content: 8-45... Offset ring wrench 8x9; 10x11; 12x13; 14x15; 16x17; 18x19; 21x23; 22x24 mm		

**8pc 45... Offset ring wrench set (SAE)**

<b>5085S</b>			
Part no.	Tip	6/10.3/11.3/0.9'	1720g
758 0608S... 2224S	Content: 8-45... Offset ring wrench 1/4"x5/16"; 3/8"x7/16"; 7/16"x1/2"; 1/2"x9/16"; 5/8"x11/16"; 11/16"x3/4"; 13/16"x7/8"; 7/8"x15/16"		



**8pc Star key set (Folding)**



<b>5087F</b>			
Part no.	Tip	100/13.0/14.0/1.6'	130g
5087F	Content: 8-Star key (Folding) T5; T6; T7; T8; T9; T10; T15; T20		

**8pc Star tamperproof key set (Folding)**

<b>5087TF</b>			
Part no.	Tip	100/13.0/14.0/1.6'	130g
5087TF	Content: 8-Star tamperproof key (Folding) T-5H; T-6H; T-7H; T-8H; T-9H; T-10H; T-15H; T-20H		





**8pc Ratchet ring wrench**

<b>50810</b>			
Part no.	Tip	6/13.0/14.0/0.9'	2160g
824 0607... 2122	Content: 8-Ratchet ring wrench 6x7; 8x9; 10x11; 12x13; 14x15; 16x18; 17x19; 21x22 mm		





**8pc Flat gear wrench set (SAE)**

<b>50812</b>		
Part no.	6/10.8/11.8/0.9'	1800g
757 5.16...3.4	Content: 8-Flat gear wrench 5/16"; 3/8"; 7/16"; 1/2"; 9/16"; 5/8"; 11/16"; 3/4"	





**8pc 15... Offset ratchet ring wrench**

<b>50811</b>			
Part no.	Tip	6/13.1/14.1/0.9'	2180g
825 0607... 2122	Content: 8-15... Offset ratchet ring wrench 6x7; 8x9; 10x11; 12x13; 14x15; 16x18; 17x19; 21x22 mm		



**8pc Reversible gear wrench set (SAE)**

<b>50813</b>		
Part no.	6/10.8/11.8/0.9'	1800g
757 5.16R... 3.4R	Content: 8-Reversible gear wrench 5/16"; 3/8"; 7/16"; 1/2"; 9/16"; 5/8"; 11/16"; 3/4"	

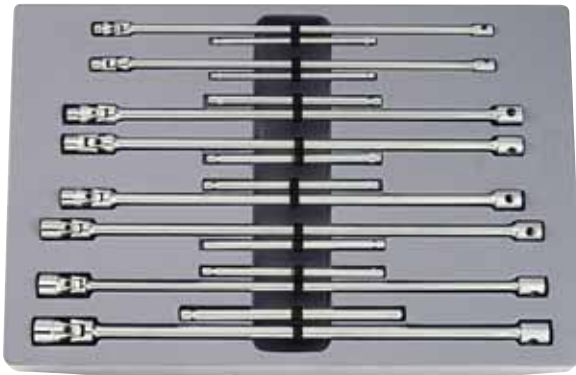
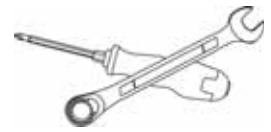

**8pc Universal long nut driver set**

**50816**



Part no.	6/24.6/25.6/2.8'	4090g
----------	------------------	-------

784 207U...  
419U

Content:  
8-Universal long nut driver  
7; 8; 10; 12; 13; 14; 17; 19 mm



**9pc Hex key set (MM)**

**5093**



Part no.	Tip	50/14.0/15.0/1.3'	280g
----------	-----	-------------------	------

764 015...10

Content:  
9-Hex key  
1.5; 2; 2.5; 3; 4; 5; 6; 8; 10 mm

**9pc Hex key set (SAE)**

**5093S**



Part no.	Tip	50/14.0/15.0/1.3'	280g
----------	-----	-------------------	------

764 1.16...3.8

Content:  
9-Hex key  
1/16"; 5/64"; 3/32"; 1/8";  
5/32"; 3/16"; 1/4"; 5/16"; 3/8"



**8pc Double ended 6pt.-6pt. socket wrench set**

**50817**



Part no.	6/7.2/8.2/0.9'	1200g
----------	----------------	-------

762 0607...1819

762220

Content:  
7-Double ended 6pt.-6pt. socket wrench  
6x7; 8x9; 10x11; 12x13; 14x15; 16x17;  
18x19  
1-Bar for double ended socket wrench  
220mmL



**9pc Hex long key set (MM)**

**5093L**



Part no.	Tip	50/19.0/20.0/2.2'	380g
----------	-----	-------------------	------

764 015L...10L

Content:  
9-Hex long key  
1.5; 2; 2.5; 3; 4; 5; 6; 8; 10 mm

**9pc Hex long key set (SAE)**

**5093LS**



Part no.	Tip	50/19.0/20.0/2.2'	380g
----------	-----	-------------------	------

764 1.16L...  
3.8L

Content:  
9-Hex long key  
1/16"; 5/64"; 3/32"; 1/8";  
5/32"; 3/16"; 1/4"; 5/16"; 3/8"





**9pc Hex ball point long key set (MM)**

<b>5093LB</b>				
Part no.	Tip	Tip	50/19.0/20.0/2.2'	380g
765 015L...10L	Content: 9-Hex ball point long key 1.5; 2; 2.5; 3; 4; 5; 6; 8; 10 mm			



**9pc Hex ball point extra long key set (MM)**

<b>5093XLB</b>				
Part no.	Tip	Tip	40/17.5/18.5/2.1'	465g
765 015XL...	Content: 9-Hex ball point extra long key 1.5; 2; 2.5; 3; 4; 5; 6; 8; 10 mm			

**9pc Hex ball point long key set (SAE)**

<b>5093LBS</b>				
Part no.	Tip	Tip	60/22.8/23.8/1.9'	380g
765 1.16L... 3.8L	Content: 9-Hex ball point long key 1/16"; 5/64"; 3/32"; 1/8"; 5/32"; 3/16"; 1/4"; 5/16"; 3/8"			

**9pc Hex ball point extra long key set (SAE)**

<b>5093XLBS</b>				
Part no.	Tip	Tip	40/17.5/18.5/2.1'	465g
765 1.16XL... 3.8XL	Content: 9-Hex ball point extra long key 1/16"; 5/64"; 3/32"; 1/8"; 5/32"; 3/16"; 1/4"; 5/16"; 3/8"			



**9pc Hex extra long key set (MM)**

<b>5093XL</b>			
Part no.	Tip	40/17.5/18.5/2.1'	465g
764 015XL... 10XL	Content: 9-Hex extra long key 1.5; 2; 2.5; 3; 4; 5; 6; 8; 10 mm		

**9pc Hex extra long key set (SAE)**

<b>5093XLS</b>			
Part no.	Tip	40/18.6/19.6/2.1'	465g
764 1.16XL... 3.8XL	Content: 9-Hex extra long key 1/16"; 5/64"; 3/32"; 1/8"; 5/32"; 3/16"; 1/4"; 5/16"; 3/8"		



**9pc Combination wrench set**

<b>5094</b>		
Part no.	10/11.1/12.2/1'	1250g
755 08...19	Content: 9-Combination wrench 8; 10; 11; 12; 13; 14; 15; 17; 19 mm	

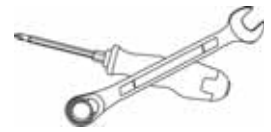

**9pc Star key set**

<b>5098</b>			
Part no.	Tip	80/20.0/21.0/1.7'	250g
766 10...50	Content: 9- Star key T10; T15; T20; T25; T27; T30; T40; T45; T50		



**9pc Star long key set**

<b>5099L</b>			
Part no.	Tip	30/22.0/23.0/0.6'	733g
766 20L...60L	Content: 9- Star long key T20; T25; T27; T30; T40; T45; T50; T55; T60		

**9pc Star tamperproof key set**

<b>5098T</b>			
Part no.	Tip	80/20.0/21.0/1.7'	250g
767 10...50	Content: 9- Star tamperproof key T-10H; T-15H; T-20H; T-25H; T-27H; T-30H; T-40H; T-45H; T-50H		

**9pc Star tamperproof long key set**

<b>5099LT</b>			
Part no.	Tip	30/22.0/23.0/0.6'	733g
767 20L...60L	Content: 9- Star tamperproof long key T-20H; T-25H; T-27H; T-30H; T-40H; T-45H; T-50H; T-55H; T-60H		



**9pc Star long key set**

<b>5098L</b>			
Part no.	Tip	50/16.5/17.5/1.8'	870g
766 10L...50L	Content: 9- Star long key T10; T15; T20; T25; T27; T30; T40; T45; T50		

**9pc Star tamperproof long key set**

<b>5098LT</b>			
Part no.	Tip	50/16.5/17.5/1.8'	870g
767 10L...50L	Content: 9- Star tamperproof long key T-10H; T-15H; T-20H; T-25H; T-27H; T-30H; T-40H; T-45H; T-50H		

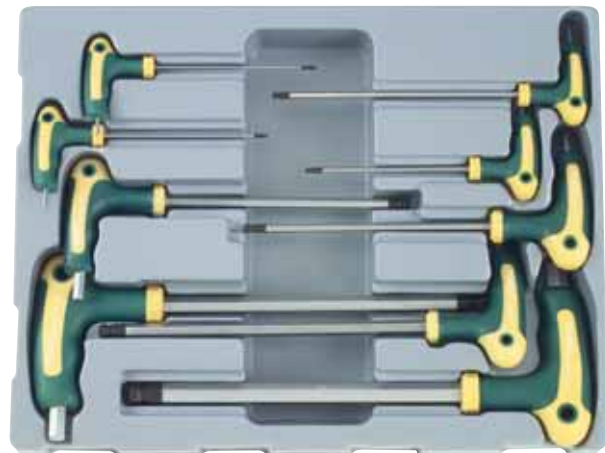

**9pc Hex ball point grip key set (SAE)**

<b>50910BS</b>			
Part no.	Tip	6/8.0/9.5/1.3'	1340g
765 5.64...1.2	Content: 9- Hex ball point grip key 5/64"; 3/32"; 1/8"; 5/32"; 3/16"; 1/4"; 5/16"; 3/8"; 1/2"		

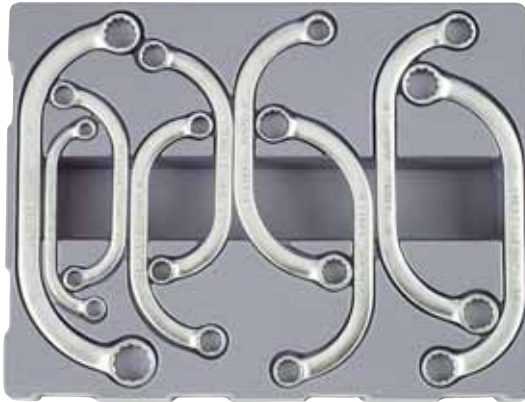

**9pc Half-moon ring wrench set**

<b>50911</b>			
Part no.	Tip	6/8.3/9.8/1.3'	1390g
761 0810...1922	Content: 9- Half-moon ring wrench 8x10; 10x12; 11x13; 12x14; 13x15; 14x17; 16x18; 17x19; 19x22 mm		



**9pc Five-sided star tamperproof L key set**

<b>50913</b>			
Part no.	Tip	80/20.0/21.0/1.7'	250g
76F 10...50	Content: 9- Five-sided star tamperproof L key TS10; TS15; TS20; TS25; TS27; TS30; TS40; TS45; TS50		

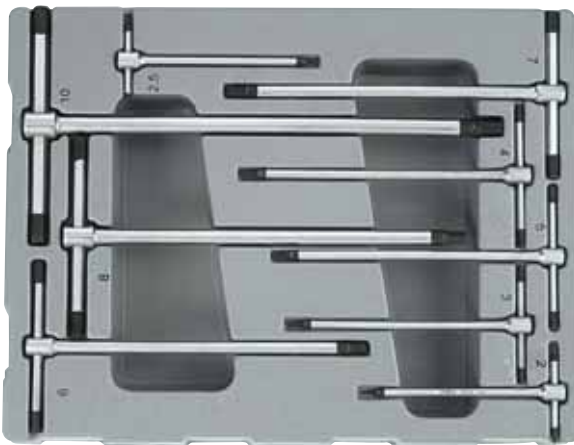

**9pc T shaped hex key set**

<b>50912</b>			
Part no.	Tip	6/7.9/9.4/1.3'	1310g
764 02T...10T	Content: 9- T shaped hex key 2; 2.5; 3; 4; 5; 6; 7; 8; 10 mm		



**10pc Hex key set**

<b>5102</b>			
Part no.	Tip	50/13.0/14.0/1.2'	260g
764 0127...10	Content: 10- Hex key 1.27; 1.5; 2; 2.5; 3; 4; 5; 6; 8; 10 mm		



**10pc Hex long key set**

<b>5102L</b>			
Part no.	Tip	50/19.4/20.4/2.2'	386g
764 0127L... 10L	Content: 10- Hex long key 1.27; 1.5; 2; 2.5; 3; 4; 5; 6; 8; 10 mm		

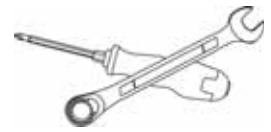

**10pc Hex extra long key set**

<b>5102XL</b>			
Part no.	Tip	40/17.5/18.5/2.1'	438g
764 0127XL... 10XL	Content: 10-Hex extra long key 1.27; 1.5; 2; 2.5; 3; 4; 5; 6; 8; 10 mm		



**10pc Double open end wrench set (MM)**

<b>5103</b>		
Part no.	10/21.0/22.0/1.6'	2100g
754 0607...3032	Content: 10-Double open end wrench 6x7; 8x9; 10x11; 12x13; 14x15; 16x17; 18x19; 20x22; 24x27; 30x32 mm	

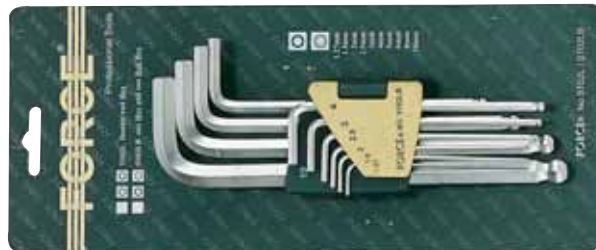

**10pc Hex ball point long key set**

<b>5102LB</b>				
Part no.	Tip	Tip	50/19.4/20.4/2'	386g
765 0127L... 10L	Content: 10-Hex ball point long key 1.27; 1.5; 2; 2.5; 3; 4; 5; 6; 8; 10 mm			

**10pc Double open end wrench set (SAE)**

<b>5103S</b>		
Part no.	10/21.0/22.0/1.6'	2100g
754 0608S... 2932S	Content: 10-Double open end wrench 1/4"x5/16"; 5/16"x3/8"; 3/8"x7/16"; 1/2"x9/16"; 9/16"x5/8"; 11/16"x3/4"; 13/16"x7/8"; 15/16"x1"; 15/16"x1-1/16"; 1-1/8"x1-1/4"	



**10pc Hex ball point extra long key set**

<b>5102XLB</b>				
Part no.	Tip	Tip	40/17.5/18.5/2.1'	438g
765 0127XL... 10XL	Content: 10-Hex ball point extra long key 1.27; 1.5; 2; 2.5; 3; 4; 5; 6; 8; 10 mm			

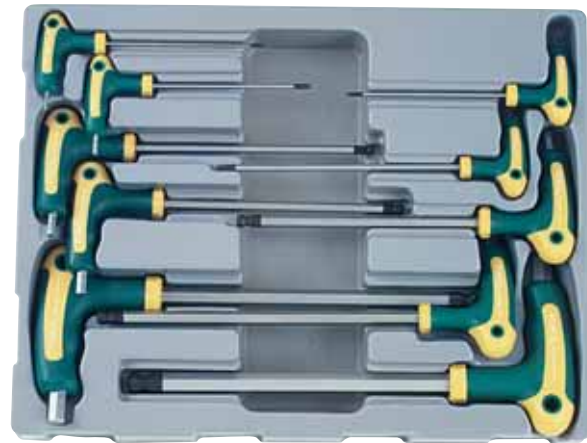

**10pc Hex ball point grip key set**

<b>5106B</b>				
Part no.	Tip	Tip	6/17.8/18.8/1.3'	2967g
765 02G...12G	Content: 10-Hex ball point grip key 2; 2.5; 3; 4; 5; 6; 7; 8; 10; 12 mm			





**10pc Hex key set (SAE)**

<b>5109S</b>			
Part no.	Tip	60/27.0/28.0/2.2	450g
764 1.16...1.2	Content: 10-Hex key 1/16"; 5/64"; 3/32"; 1/8"; 5/32"; 3/16"; 1/4"; 5/16"; 3/8"; 1/2"		



**11pc Double open end wrench set(MM)**

<b>5111</b>		
Part no.	6/12.6/13.6/0.8'	2666g
754 0607...3032	Content: 11-Double open end wrench 6x7; 8x9; 10x11; 12x13; 14x15; 16x17; 18x19; 20x22; 21x23; 24x27; 30x32 mm	

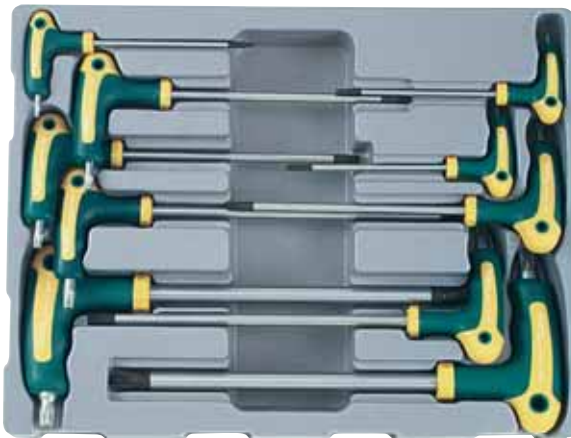

**10pc Star tamperproof grip key set**

<b>51010T</b>			
Part no.	Tip	6/7.8/8.8/1.3'	1500g
767 10G...55G	Content: 10-Star tamperproof grip key T-10H; T-15H; T-20H; T-25H; T-27H; T-30H; T-40H; T-45H; T-50H; T-55H		

**11pc Double open end wrench set(SAE)**

<b>5111S</b>		
Part no.	6/12.6/13.6/0.8'	2666g
754 0608S... 2932S	Content: 11-Double open end wrench 1/4"x5/16"; 5/16"x3/8"; 3/8"x7/16"; 1/2"x9/16"; 9/16"x5/8"; 5/8"x11/16"; 11/16"x3/4"; 13/16"x7/8"; 15/16"x1"; 15/16"x1-1/16"; 1-1/8"x1-1/4"	

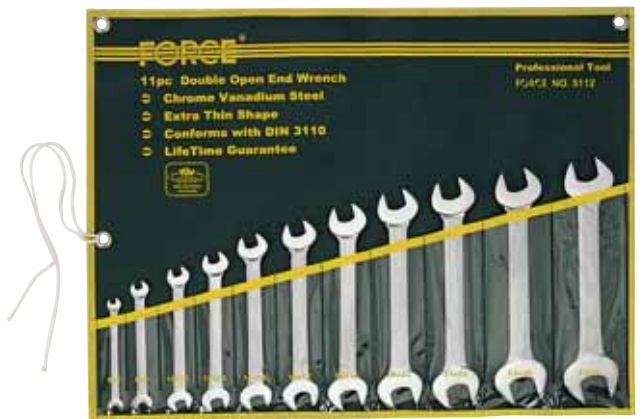

**11pc Double open end wrench set(MM)**

<b>5112</b>		
Part no.	10/20.0/21.0/1.3'	2000g
754 0607...2427	Content: 11-Double open end wrench 6x7; 8x9; 10x11; 12x13; 14x15; 16x17; 18x19; 20x22; 21x23; 23x26; 24x27 mm	



**11pc Double open end wrench set(SAE)**

**5112S**



Part no.	10/20.0/21.0/1.3'	2000g
----------	-------------------	-------

754 0608S...  
2932S

Content:  
11-Double open end wrench  
1/4"x5/16"; 5/16"x3/8";  
3/8"x7/16"; 1/2"x9/16";  
9/16"x5/8"; 5/8"x11/16";  
11/16"x3/4"; 13/16"x7/8";  
15/16"x1-1/16"; 1"x1-1/8";  
1-1/8"x1-1/4"



**11pc Combination wrench set(MM)**

**5115**



Part no.	12/15.3/16.3/1'	1270g
----------	-----------------	-------

755 08...22

Content:  
11-Combination wrench  
8; 10; 11; 12; 13; 14; 15; 17; 19;  
21; 22 mm

**11pc Combination wrench set(SAE)**

**5115S**



Part no.	12/15.3/16.3/1'	1270g
----------	-----------------	-------

755 1.4...7.8

Content:  
11-Combination wrench  
1/4"; 5/16"; 3/8"; 7/16"; 1/2";  
9/16"; 5/8"; 11/16"; 3/4";  
13/16"; 7/8"

**11pc Hex key set**

**5116**



Part no.	Tip	40/18.0/19.0/1.6'	490g
----------	-----	-------------------	------

764 015...12

Content:  
11-Hex key  
1.5; 2; 2.5; 3; 4; 5; 6; 7; 8; 10;  
12 mm



**11pc Hex long key set**

**5116L**



Part no.	Tip	30/12.0/13.0/1.58'	400g
----------	-----	--------------------	------

764 015L...12L

Content:  
11-Hex long key  
1.5; 2; 2.5; 3; 4; 5; 6; 7; 8; 10;  
12 mm



**11pc Hex extra long key set**

<b>5116XL</b>			
Part no.	Tip	40/18.5/19.5/2.2'	463g
764 015XL...12XL	Content: 11-Hex extra long key 1.5; 2; 2.5; 3; 4; 5; 6; 7; 8; 10; 12 mm		



**11pc Hex ball point long key set**

<b>5116LB</b>				
Part no.	Tip	Tip	30/12.0/13.0/1.58'	400g
765 015L...12L	Content: 11-Hex ball point long key 1.5; 2; 2.5; 3; 4; 5; 6; 7; 8; 10; 12 mm			



**12pc Combination wrench set(MM)**

<b>5121</b>		
Part no.	10/14.0/15.0/1.3'	1400g
755 08...23	Content: 12-Combination wrench 8; 10; 11; 12; 13; 14; 15; 16; 17; 19; 22; 23 mm	

**12pc Combination wrench set(SAE)**

<b>5121S</b>		
Part no.	10/14.0/15.0/1.3'	1400g
755 1.4...15.16	Content: 12-Combination wrench 1/4"; 5/16"; 3/8"; 7/16"; 1/2"; 9/16"; 5/8"; 11/16"; 3/4"; 13/16"; 7/8"; 15/16"	



**12pc Combination wrench set(MM)**

<b>5123</b>		
Part no.	10/16.5/17.5/1.1'	1550g
755 08...22	Content: 12-Combination wrench 8; 10; 11; 12; 13; 14; 15; 16; 17; 18; 19; 22 mm	

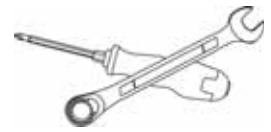

**12pc Double open end wrench set**

<b>5128P</b>		
Part no.	10/19.8/20.8/1.3'	1980g
754 0607...3032	Content: 12-Double open end wrench 6x7; 8x9; 10x11; 12x13; 14x15; 16x17; 18x19; 20x22; 21x23; 24x27; 25x28; 30x32 mm	

**12pc Flexible gear wrench set (MM)**

<b>K51210F</b>		
Part no.	6/14.4/15.4/1.5'	2376g
757 08F...19F	Content: 12- Flexible gear wrench 8; 9; 10; 11; 12; 13; 14; 15; 16; 17; 18; 19 mm	



**12pc Flat gear wrench set (MM)**

<b>51210</b>		
Part no.	6/13.0/14.0/0.9'	2270g
757 08...19	Content: 12- Flat gear wrench 8; 9; 10; 11; 12; 13; 14; 15; 16; 17; 18; 19 mm	

**12pc Reversible gear wrench set(MM)**

<b>51211</b>		
Part no.	6/13.6/14.6/0.9'	2270g
757 08R...19R	Content: 12- Reversible gear wrench 8; 9; 10; 11; 12; 13; 14; 15; 16; 17; 18; 19 mm	





**12pc 75... Offset ring wrench set**

<b>51213P</b>			
Part no.	Socket	6/20.4/21.4/1.9'	3400g
759 0607...3032	Content: 12- 75... offset ring wrench 6x7; 8x9; 10x11; 12x13; 14x15; 16x17; 18x19; 20x22; 21x23; 24x27; 25x28; 30x32 mm		



**12pc Midget combination wrench set**

<b>51214P</b>		
Part no.	20/17.7/18.7/1.3'	885g
755S 08...19	Content: 12-Midget combination wrench 8; 9; 10; 11; 12; 13; 14; 15; 16; 17; 18; 19 mm	



**12pc Midget combination wrench set**

<b>51214</b>		
Part no.	6/6.5/7.5/0.9'	1090g
755S 08...19	Content: 12-Midget combination wrench 8; 9; 10; 11; 12; 13; 14; 15; 16; 17; 18; 19 mm	



**12pc Flat gear wrench & holder set (SAE)**

<b>51215</b>		
Part no.	6/8.0/9.0/0.9'	1320g
757 5.16...3.4	Content: 8-Flat gear wrench 5/16"; 3/8"; 7/16"; 1/2"; 9/16"; 5/8"; 11/16"; 3/4"	
831 210...419	3-Gear wrench socket holder 1/4"DR.(10mm); 3/8"DR.(13mm); 1/2"DR.(19mm)	
831H210	1-Gear wrench bit holder 1/4"Hex(10mm)	



**12pc Reversible gear wrench & holder set (SAE)**

**51215R**



Part no.	6/8.0/9.0/0.9'	1320g
----------	----------------	-------

757 5.16R...3.4R	Content: 8-Reversible gear wrench 5/16"; 3/8"; 7/16"; 1/2"; 9/16"; 5/8"; 11/16"; 3/4"
831 210...419	3-Gear wrench socket holder 1/4"DR.(10mm); 3/8"DR.(13mm); 1/2"DR.(19mm)
831H210	1-Gear wrench bit holder 1/4"Hex(10mm)



**13pc Combination wrench set (SAE)**

**5134**



Part no.	6/15.0/16.0/0.9'	2500g
----------	------------------	-------

755 1.4...1	Content: 13-Combination wrench 1/4"; 5/16"; 3/8"; 7/16"; 1/2"; 9/16"; 5/8"; 11/16"; 3/4"; 13/16"; 7/8"; 15/16"; 1"
-------------	--



**12pc Stubby flat gear wrench set**

**K51216**



Part no.	6/8.0/9.0/0.8'	1320g
----------	----------------	-------

757S 08...19	Content: 12-Stubby flat gear wrench 8; 9; 10; 11; 12; 13; 14; 15; 16; 17; 18; 19 mm
--------------	--



**13pc Crowfoot flare nut wrench set (SAE)**

**5135S**



Part no.	6/12.0/13.0/0.9'	2000g
----------	------------------	-------

7513 3.8...7.8	Content: 9-3/8"DR. 12pt. Crowfoot flare nut 3/8"; 7/16"; 1/2"; 9/16"; 5/8"; 11/16"; 3/4"; 13/16"; 7/8"
7514 15.16...1.0	2-1/2"DR. 12pt. Crowfoot flare nut 15/16"; 1"
808306	2-Locking extension 3/8"DR.(150mmL)
808405	1/2"DR.(125mmL)



**13pc Hex key set (MM)**

<b>5137</b>			
Part no.	Tip	12/22.5/23.5/1.3'	1880g
764 02...19	Content: 13-Hex key 2; 2.5; 3; 4; 5; 6; 7; 8; 10; 12; 14; 17; 19 mm		

**13pc Hex key set (SAE)**

<b>5137S</b>			
Part no.	Tip	12/22.5/23.5/1.3'	1880g
764 1.16...3.4	Content: 13-Hex key 1/16"; 5/64"; 3/32"; 1/8"; 5/32"; 3/16"; 1/4"; 5/16"; 3/8"; 1/2"; 9/16"; 5/8"; 3/4"		



**13pc Hex extra long key set (MM)**

<b>5137XL</b>			
Part no.	Tip	6/18.2/19.2/0.68'	3030g
764 02XL...19XL	Content: 13-Hex extra long key 2; 2.5; 3; 4; 5; 6; 7; 8; 10; 12; 14; 17; 19 mm		



**14pc Combination wrench set (MM)**

<b>5141</b>		
Part no.	6/19.7/20.7/1.2'	3283g
755 10...32	Content: 14-Combination wrench 10; 11; 12; 13; 14; 17; 19; 21; 22; 23; 24; 27; 30; 32 mm	

**14pc Combination wrench set (SAE)**

<b>5141S</b>		
Part no.	6/19.7/20.7/1.2'	3283g
755 5.16...1.1.4	Content: 14-Combination wrench 5/16"; 3/8"; 7/16"; 1/2"; 9/16"; 5/8"; 11/16"; 3/4"; 13/16"; 7/8"; 15/16"; 1"; 1-1/8"; 1-1/4"	



**15pc Star key set**

<b>5151</b>			
Part no.	Tip	20/13.4/14.4/0.76'	670g
766 06...60	Content: 15-Star key T6; T7; T8; T9; T10; T15; T20; T25; T27; T30; T40; T45; T50; T55; T60		



**15pc Star tamperproof key set**

<b>5151T</b>			
Part no.	Tip	20/13.4/14.4/0.76'	670g
767 06...60	Content: 15-Star tamperproof key T-6H; T-7H; T-8H; T-9H; T-10H; T-15H; T-20H; T-25H; T-27H; T-30H; T-40H; T-45H; T-50H; T-55H; T-60H		



**16pc Combination wrench set**

<b>5161</b>		
Part no.	6/14.0/15.0/0.9'	2333g
755 06...24	Content: 16-Combination wrench 6; 7; 8; 9; 10; 11; 12; 13; 14; 15; 16; 17; 18; 19; 22; 24 mm	

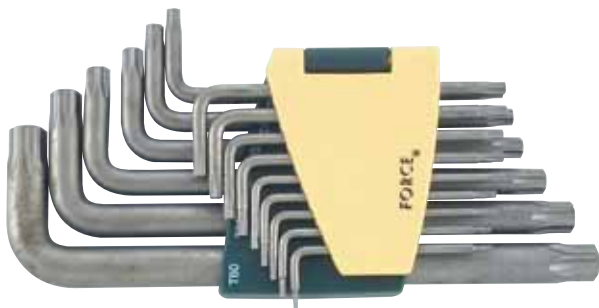

**15pc Star long key set**

<b>5151L</b>			
Part no.	Tip	20/17.5/18.5/1.3'	870g
766 06L...60L	Content: 15-Star long key T6; T7; T8; T9; T10; T15; T20; T25; T27; T30; T40; T45; T50; T55; T60		

**15pc Star tamperproof long key set**

<b>5151LT</b>			
Part no.	Tip	20/13.4/14.4/1.3'	670g
767 06L...60L	Content: 15-Star tamperproof key T-6H; T-7H; T-8H; T-9H; T-10H; T-15H; T-20H; T-25H; T-27H; T-30H; T-40H; T-45H; T-50H; T-55H; T-60H		



**16pc Flat gear wrench & holder set**

<b>5164</b>		
Part no.	6/10.7/11.7/0.9'	1790g
757 08...19	Content: 12-Flat gear wrench 8; 9; 10; 11; 12; 13; 14; 15; 16; 17; 18; 19 mm	
831 210...419	3-Gear wrench socket holder 1/4"DR.(10mm); 3/8"DR.(13mm); 1/2"DR.(19mm)	
831H210	1-Gear wrench bit holder 1/4"Hex (10mm)	





**16pc Reversible gear wrench & holder set**

<b>5164R</b>		
Part no.	6/10.7/11.7/0.9'	1790g
757 08R...19R 831 210...419 831H210	<p>Content:</p> <p>12-Reversible gear wrench 8; 9; 10; 11; 12; 13; 14; 15; 16; 17; 18; 19 mm</p> <p>3-Gear wrench socket holder 1/4"DR.(10mm); 3/8"DR.(13mm); 1/2"DR.(19mm)</p> <p>1-Gear wrench bit holder 1/4"Hex (10mm)</p>	



**19pc Combination wrench set**

<b>5191</b>		
Part no.	10/24.5/25.5/1.3'	2300g
755 06...24	<p>Content:</p> <p>19-Combination wrench 6; 7; 8; 9; 10; 11; 12; 13; 14; 15; 16; 17; 18; 19; 20; 21; 22; 23; 24 mm</p>	



**17pc Crowfoot flare nut wrench set (MM)**

<b>5172</b>		
Part no.	6/13.8/14.8/0.9'	2300g
7513 10...22 7514 23...26 808306 808405	<p>Content:</p> <p>12-3/8"DR. 12pt. Crowfoot flare nut 10; 11; 12; 13; 14; 15; 16; 17; 18; 19; 21; 22 mm</p> <p>3-1/2"DR. 12pt. Crowfoot flare nut 23; 24; 26 mm</p> <p>2-Locking extension 3/8"DR.(150mmL) 1/2"DR.(125mmL)</p>	





**19pc Spline combination wrench set**

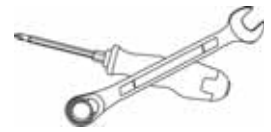

<b>5191Q</b>		
Part no.	10/24.5/25.5/1.3'	2300g
755 06Q...24Q	<p>Content:</p> <p>19-Spline combination wrench M6; M7; M8; M9; M10; M11; M12; M13; M14; M15; M16; M17; M18; M19; M20; M21; M22; M23; M24</p>	



**19pc 75... Offset combination wrench set**



<b>5192</b>		
Part no.	8/18.4/19.4/3.4'	2300g
755 06A...24A	Content: 19-75... Offset combination wrench 6; 7; 8; 9; 10; 11; 12; 13; 14; 15; 16; 17; 18; 19; 20; 21; 22; 23; 24 mm	

**26pc Combination wrench set**

<b>5261P</b>		
Part no.	3/15.6/16.6/1'	8200g
755 06...32	Content: 26-Combination wrench 6; 7; 8; 9; 10; 11; 12; 13; 14; 15; 16; 17; 18; 19; 20; 21; 22; 23; 24; 25; 26; 27; 28; 29; 30; 32 mm	



**26pc Combination wrench set**

<b>5261</b>		
Part no.	3/24.6/25.6/3.6'	8200g
755 06...32	Content: 26-Combination wrench 6; 7; 8; 9; 10; 11; 12; 13; 14; 15; 16; 17; 18; 19; 20; 21; 22; 23; 24; 25; 26; 27; 28; 29; 30; 32 mm	



**5pc Spline key set**

<b>5501</b>			
Part no.	Tip	30/16.0/17.0/0.9'	533g
768 05K...12K	Content: 5-Spline key M5; M6; M8; M10; M12		

**34pc Tools set**

<b>5341</b>		
Part no.	3/15.6/16.6/1.7'	5200g
754 0607...1617	Content: 6-Double open end wrench 6x7; 8x9; 10x11; 12x13; 14x15; 16x17 mm	
5102	10 pc L key set	
764 0127...10	1.27; 1.5; 2; 2.5; 3; 4; 5; 6; 8; 10 mm	
711 0B...2B	3-Phillips screwdriver PH.0 (60mmL); PH.1 (80mmL); PH.2(100mmL)	
713 03B...065B	5-Slotted screwdriver 3(75mmL); 3.5(100mmL); 4(100mmL); 5.5(125mmL); 6.5(150mmL)	
613B250	1-Waterpump pliers 10"	
610B160	1-Long nose pliers 6"	
611B175	1-Combination pliers 7"	
616300	1-Engineer hammer 300g	
5096P803	1-Measuring tape 3m	
649200A	1-Adjustable gauged wrench 8"	
5055P4	1-Utility knife (incl. 2pc blades)	
6982	1-Technician's scissors	
66303	1-Hacksaw	
68601	1-LED white light, clip-type (360° rotation)	



**Phillips screwdriver**

<b>711..</b>		<i>l</i>	<i>L</i>		
Part no.	Tip	blade	over	g	pc/box
7111S	PH.1	38	103	43	10
7112S	PH.2	38	103	48	10
7110	PH.0	60	135	21	10
7111	PH.1	80	180	62	10
7112	PH.2	100	215	89	10
7113	PH.3	150	275	153	10

**Hammer Phillips screwdriver**

<b>711..M</b>		<i>l</i>	<i>L</i>		
Part no.	Tip	blade	over	g	pc/box
7111M	PH.1	80	185	96	10
7112M	PH.2	100	215	138	10
7113M	PH.3	150	275	231	10
7114M	PH.4	200	325	329	10
7113004M	PH.4	300	425	205	10



**Insulated Phillips screwdriver**

<b>711..N</b>		<i>l</i>	<i>L</i>		
Part no.	Tip	blade	over	g	pc/box
7110N	PH.0	60	145	34	10
7111N	PH.1	80	185	71	10
7112N	PH.2	100	215	102	10
7113N	PH.3	150	275	183	10

**Phillips anti-slip screwdriver (Round steel)**

<b>711..B</b>		<i>l</i>	<i>L</i>		
Part no.	Tip	blade	over	g	pc/box
7111BS	PH.1	25	75	39	10
7112BS	PH.2	25	75	42	10
7110B	PH.0	60	145	33	10



**Pozidriv screwdriver**

<b>712..</b>		<i>l</i>	<i>L</i>		
Part no.	Tip	blade	over	g	pc/box
7121S	PZ.1	38	103	43	10
7122S	PZ.2	38	103	48	10
7120	PZ.0	60	135	21	10
7121	PZ.1	80	180	62	10
7122	PZ.2	100	215	86	10
7123	PZ.3	150	275	153	10

**Phillips anti-slip screwdriver (Hexagon steel & Hexagon driver)**

<b>711..B</b>		<i>l</i>	<i>L</i>		
Part no.	Tip	blade	over	g	pc/box
7111B	PH.1	80	185	79	10
7112B	PH.2	100	215	114	10
7113B	PH.3	150	275	226	10





**Pozidriv anti-slip screwdriver (Round steel)**

<b>712..B</b>		<i>l</i>	<i>L</i>		
Part no.	Tip	blade	over	g	pc/box
7121BS	PZ.1	25	75	38	10
7122BS	PZ.2	25	75	42	10
7120B	PZ.0	60	145	32	10



**Pozidriv anti-slip screwdriver (Hexagon steel & Hexagon driver)**

<b>712..B</b>		<i>l</i>	<i>L</i>		
Part no.	Tip	blade	over	g	pc/box
7121B	PZ.1	80	185	79	10
7122B	PZ.2	100	215	114	10
7123B	PZ.3	150	275	197	10



**Hammer pozidriv screwdriver**

<b>712..M</b>		<i>l</i>	<i>L</i>		
Part no.	Tip	blade	over	g	pc/box
7121M	PZ.1	80	185	88	10
7122M	PZ.2	100	215	138	10
7123M	PZ.3	150	275	231	10
7124M	PZ.4	200	325	316	10
7123004M	PZ.4	300	425	380	5



**Insulated pozidriv screwdriver**

<b>712..N</b>		<i>l</i>	<i>L</i>		
Part no.	Tip	blade	over	g	pc/box
7120N	PZ.0	60	145	30	10
7121N	PZ.1	80	185	66	10
7122N	PZ.2	100	215	96	10
7123N	PZ.3	150	275	185	10

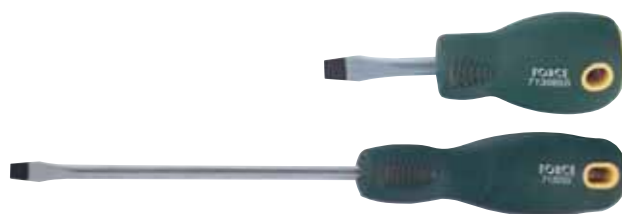

**Slotted screwdriver**

<b>713..</b>		<i>l</i>	<i>L</i>		
Part no.	Tip	blade	over	g	pc/box
713055S	1.0 x 5.5	38	103	43	10
713065S	1.2 x 6.5	38	103	48	10
71303	0.5 x 3	75	145	21	10
713035	0.5 x 3.5	100	175	24	10
71304	0.8 x 4	100	175	28	10
713055	1.0 x 5.5	125	225	69	10
713065	1.2 x 6.5	150	265	100	10
71308	1.2 x 8	175	300	162	10



**Slotted anti-slip screwdriver (Round steel)**

<b>713..B</b>		<i>l</i>	<i>L</i>		
Part no.	Tip	blade	over	g	pc/box
713055BS	1.0 x 5.5	25	75	36	10
713065BS	1.2 x 6.5	25	75	40	10
71303B	0.5 x 3	75	160	31	10
713035B	0.5 x 3.5	100	185	35	10
71304B	0.8 x 4	100	205	58	10
713055B	1.0 x 5.5	125	230	65	10



**Slotted anti-slip screwdriver  
(Hexagon steel & Hexagon driver)**

**Hex anti-slip screwdriver**

<b>713..B</b>		<i>l</i>	<i>L</i>		
Part no.	Tip	blade	over	g	pc/box
713065B	1.2 x 6.5	150	265	132	10
71308B	1.2 x 8	175	300	206	10

<b>714..B</b>		<i>l</i>	<i>L</i>		
Part no.	Tip	blade	over	g	pc/box
71402B	2	100	160	31	10
714025B	2.5	100	160	33	10
71403B	3	100	160	36	10
71404B	4	100	180	66	10
71405B	5	100	180	76	10
71406B	6	125	215	109	10
71408B	8	150	225	174	10
71410B	10	150	225	222	10



**Hammer slotted screwdriver**

**Hex ball point anti-slip screwdriver**

<b>713..M</b>		<i>l</i>	<i>L</i>		
Part no.	Tip	blade	over	g	pc/box
713055M	5.5	125	230	103	10
713065M	6.5	150	265	154	10
71308M	8	150	275	232	10
71310M	10	200	325	327	10
71312M	12	200	325	329	10
71314M	14	250	375	364	10

<b>715..B</b>		<i>l</i>	<i>L</i>		
Part no.	Tip	blade	over	g	pc/box
71502B	2	100	185	27	10
715025B	2.5	100	185	29	10
71503B	3	100	185	32	10
71504B	4	100	205	66	10
71505B	5	100	205	76	10
71506B	6	125	240	109	10
71508B	8	150	275	187	10
71510B	10	150	275	221	10



**Insulated slotted screwdriver**

<b>713..N</b>		<i>l</i>	<i>L</i>		
Part no.	Tip	blade	over	g	pc/box
713024N	2.4	75	160	32	10
71303N	3	100	185	38	10
713035N	3.5	100	185	38	10
71304N	4	100	205	66	10
713055N	5.5	125	240	87	10
713065N	6.5	150	265	122	10
71308N	8	175	300	194	10



**Star screwdriver**

<b>716</b>		<i>l</i>	<i>L</i>		
Part no.	Tip	blade	over	g	pc/box
71605	T5	75	150	25	10
71606	T6	75	150	25	10
71607	T7	75	150	25	10
71608	T8	75	150	25	10
71609	T9	75	150	25	10
71610	T10	100	205	65	10
71615	T15	100	205	65	10
71620	T20	100	205	65	10
71625	T25	100	215	90	10
71627	T27	100	215	90	10
71630	T30	100	215	90	10
71640	T40	100	215	102	10
71645	T45	100	225	133	10

**Star tamperproof screwdriver**

<b>717</b>		<i>l</i>	<i>L</i>		
Part no.	Tip	blade	over	g	pc/box
71706	T-6H	75	150	25	10
71707	T-7H	75	150	25	10
71708	T-8H	75	150	25	10
71709	T-9H	75	150	25	10
71710	T-10H	100	205	65	10
71715	T-15H	100	205	65	10
71720	T-20H	100	205	65	10
71725	T-25H	100	215	90	10
71727	T-27H	100	215	90	10
71730	T-30H	100	215	90	10
71740	T-40H	100	215	102	10
71745	T-45H	100	215	133	10

**Star anti-slip screwdriver**

<b>716..B</b>		<i>l</i>	<i>L</i>		
Part no.	Tip	blade	over	g	pc/box
71605B	T5	60	145	32	10
71606B	T6	60	145	32	10
71607B	T7	60	145	32	10
71608B	T8	60	145	32	10
71609B	T9	60	145	32	10
71610B	T10	80	185	34	10
71615B	T15	80	185	35	10
71620B	T20	100	205	65	10
71625B	T25	100	205	73	10
71627B	T27	115	230	106	10
71630B	T30	115	230	107	10
71640B	T40	130	245	153	10
71645B	T45	130	255	166	10
71618506B	T6	100	185	38	10
71618507B	T7	100	185	38	10
71618508B	T8	100	185	38	10
71618509B	T9	100	185	38	10

**Star tamperproof anti-slip screwdriver**

<b>717..B</b>		<i>l</i>	<i>L</i>		
Part no.	Tip	blade	over	g	pc/box
71705B	T-5H	60	145	31	10
71706B	T-6H	60	145	31	10
71707B	T-7H	60	145	33	10
71708B	T-8H	60	145	33	10
71709B	T-9H	60	145	32	10
71710B	T-10H	80	185	62	10
71715B	T-15H	80	185	62	10
71720B	T-20H	100	205	64	10
71725B	T-25H	100	205	73	10
71727B	T-27H	115	230	106	10
71730B	T-30H	115	230	107	10
71740B	T-40H	130	245	151	10
71745B	T-45H	130	255	168	10



**Hex screwdriver T handle**

<b>724</b>		<i>l</i>	<i>L</i>		
Part no.	Tip	blade	over	g	pc/box
72402	2	100	130	30	10
724025	2.5	100	130	30	10
72403	3	100	130	34	10
72404	4	150	185	54	10
72405	5	150	185	66	10
72406	6	200	240	113	5
72407	7	200	240	136	5
72408	8	200	240	138	5
72410	10	200	240	240	5
7243.32	3/32"	100	130	30	10
7247.64	7/64"	100	130	30	10
7241.8	1/8"	100	130	34	10
7245.32	5/32"	150	185	54	10
7243.16	3/16"	150	185	66	10
7247.32	7/32"	200	240	113	10
7241.4	1/4"	200	240	136	5
7245.16	5/16"	200	240	138	5
7243.8	3/8"	200	240	240	5

**Star screwdriver T handle**

<b>726</b>		<i>l</i>	<i>L</i>		
Part no.	Tip	blade	over	g	pc/box
72606	T6	100	130	32	10
72607	T7	100	130	33	10
72608	T8	100	130	33	10
72609	T9	100	130	33	10
72610	T10	100	130	33	10
72615	T15	100	130	39	10
72620	T20	100	135	52	10
72625	T25	100	135	58	10
72627	T27	200	240	58	10
72630	T30	200	240	58	10
72640	T40	200	240	68	10
72645	T45	200	240	79	10
72650	T50	200	240	93	10
72655	T55	200	240	130	10
72623520	T20	200	235	56	10
72623525	T25	200	235	68	10

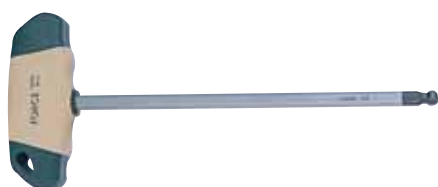

**Star tamperproof screwdriver T handle**

<b>727</b>		<i>l</i>	<i>L</i>		
Part no.	Tip	blade	over	g	pc/box
72706	T-6H	100	130	30	10
72707	T-7H	100	130	30	10
72708	T-8H	100	130	30	10
72709	T-9H	100	130	30	10
72710	T-10H	100	130	30	10
72715	T-15H	100	130	34	10
72720	T-20H	100	135	34	10
72725	T-25H	100	135	54	10
72727	T-27H	200	240	51	5
72730	T-30H	200	240	102	5
72740	T-40H	200	240	122	5
72745	T-45H	200	240	144	5
72750	T-50H	200	240	170	5
72755	T-55H	200	240	258	5
72723520	T-20H	200	235	56	5
72723525	T-25H	200	235	68	5

**Hex ball point screwdriver T handle**

<b>725</b>		<i>l</i>	<i>L</i>		
Part no.	Tip	blade	over	g	pc/box
72502	2	100	130	32	10
725025	2.5	100	130	32	10
72503	3	100	130	38	10
72504	4	150	185	66	10
72505	5	150	185	77	10
72506	6	200	240	137	5
72507	7	200	240	158	5
72508	8	200	240	182	5
72510	10	200	240	270	5
7253.32	3/32"	100	130	32	10
7257.64	7/64"	100	130	32	10
7251.8	1/8"	100	130	38	10
7255.32	5/32"	150	185	66	10
7253.16	3/16"	150	185	77	10
7257.32	7/32"	200	240	137	5
7251.4	1/4"	200	240	158	5
7255.16	5/16"	200	240	182	5
7253.8	3/8"	200	240	270	5





**Phillips jeweler screwdriver**

<b>731</b>		<i>l</i>	<i>L</i>		
Part no.	Tip	blade	over	g	pc/box
731040000	PH.000	40	120	14	10
73104000	PH.00	40	120	14	10
7310400	PH.0	40	120	14	10
731075000	PH.000	75	155	15	10
73107500	PH.00	75	155	16	10
7310750	PH.0	75	155	18	10
7310751	PH.1	75	155	23	10
7311500	PH.0	150	230	24	10
7311501	PH.1	150	230	24	10



**Pozidriv jeweler screwdriver**

<b>732</b>		<i>l</i>	<i>L</i>		
Part no.	Tip	blade	over	g	pc/box
73204000	PZ.00	40	120	14	10
7320750	PZ.0	75	155	18	10
7320751	PZ.1	75	155	18	10



**Slotted jeweler screwdriver**

<b>733</b>		<i>l</i>	<i>L</i>		
Part no.	Tip	blade	over	g	pc/box
733040008	0.8	40	120	14	10
73304001	1.0	40	120	14	10
733040012	1.2	40	120	14	10
733040015	1.5	40	120	14	10
733040018	1.8	40	120	14	10
73304002	2.0	40	120	14	10
733040024	2.4	40	120	14	10
73307502	2.0	75	155	18	10
733075024	2.4	75	155	18	10
73307503	3.0	75	155	18	10
733075035	3.5	75	155	18	10
73307504	4.0	75	155	18	10
73310002	2.0	100	180	20	10
733100024	2.4	100	180	20	10
73310003	3.0	100	180	20	10
73310004	4.0	100	180	20	10
73315003	3.0	150	230	24	10
733150035	3.5	150	230	24	10
73315004	4.0	150	230	24	10



**Hex jeweler screwdriver**

<b>734</b>		<i>l</i>	<i>L</i>		
Part no.	Tip	blade	over	g	pc/box
734040007	0.7	40	120	14	10
734040009	0.9	40	120	14	10
734040013	1.3	40	120	14	10
734040015	1.5	40	120	14	10
73407502	2.0	75	155	18	10
734075025	2.5	75	155	18	10
73407503	3.0	75	155	18	10
7340400.05	0.05"	40	120	14	10
7340401.16	1/16"	40	120	14	10
7340755.64	5/64"	75	155	18	10
7340753.32	3/32"	75	155	18	10
7340757.64	7/64"	75	155	18	10
7340751.8	1/8"	75	155	18	10



**Hex ball jeweler screwdriver**

<b>735</b>		<i>l</i>	<i>L</i>		
Part no.	Tip	blade	over	g	pc/box
735040013	1.3	40	120	14	10
735040015	1.5	40	120	14	10
73507502	2.0	75	155	18	10
735075025	2.5	75	155	18	10
73507503	3.0	75	155	18	10

**Hex jeweler nut driver**

<b>739</b>		<i>l</i>	<i>L</i>		
Part no.	Tip	blade	over	g	pc/box
739015	1.5	75	155	24	10
739018	1.8	75	155	24	10
73902	2.0	75	155	24	10
739025	2.5	75	155	28	10
73903	3.0	75	155	28	10
739032	3.2	75	155	28	10
739035	3.5	75	155	28	10
73904	4.0	75	155	32	10
739045	4.5	75	155	32	10
73905	5.0	75	155	32	10
739055	5.5	75	155	32	10
73906	6.0	75	155	34	10
7391.8	1/8"	75	155	28	10
7393.16	3/16"	75	155	34	10

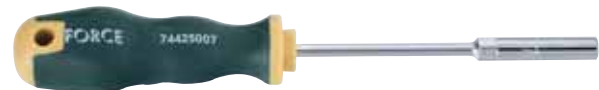

**Star jeweler screwdriver**

<b>736</b>		<i>l</i>	<i>L</i>		
Part no.	Tip	blade	over	g	pc/box
73604005	T5	40	120	14	10
73604006	T6	40	120	14	10
73604007	T7	40	120	14	10
73604008	T8	40	120	14	10
73607509	T9	75	155	18	10
73607510	T10	75	155	18	10
73607515	T15	75	155	18	10
73607520	T20	75	155	18	10

**Hex nut driver**

<b>744</b>		<i>l</i>	<i>L</i>		
Part no.	Tip	blade	over	g	pc/box
74425004	4	135	250	126	10
744250045	4.5	135	250	126	10
74425005	5	135	250	131	10
744250055	5.5	135	250	136	10
74425006	6	135	250	141	10
74425007	7	135	250	144	10
74425008	8	135	250	147	10
74425009	9	135	250	153	10
74425010	10	135	250	188	10
74425011	11	135	250	194	10
74425012	12	135	250	194	10
74425013	13	135	250	207	10
74425014	14	135	250	234	10
7442503.16	3/16"	135	250	126	10
7442501.4	1/4"	135	250	141	10
7442505.16	5/16"	135	250	147	10
7442503.8	3/8"	135	250	188	10
7442507.16	7/16"	135	250	194	10
7442501.2	1/2"	135	250	207	10
7442509.16	9/16"	135	250	234	10

**Star tamperproof jeweler screwdriver**

<b>737</b>		<i>l</i>	<i>L</i>		
Part no.	Tip	blade	over	g	pc/box
73704005	T-5H	40	120	14	10
73704006	T-6H	40	120	14	10
73704007	T-7H	40	120	15	10
73704008	T-8H	40	120	15	10
73707509	T-9H	75	155	18	10
73707510	T-10H	75	155	18	10
73707515	T-15H	75	155	21	10
73707520	T-20H	75	155	23	10



**Flare nut wrench**

<b>751</b>		<i>l</i>		
Part no.	size	mm	g	pc/box
7510810	8x10	145	50	10
7510911	9x11	152	55	10
7511011	10x11	152	64	10
7511012	10x12	152	62	10
7511113	11x13	165	86	10
7511214	12x14	178	116	10
7511314	13x14	178	95	10
7511417	14x17	210	150	10
7511618	16x18	210	198	10
7511719	17x19	210	193	10
7511722	17x22	230	244	10
7511819	18x19	210	183	10
7511922	19x22	233	259	5
7512427	24x27	265	378	5
7513032	30x32	285	457	5
7513641	36x41	350	884	5
7510810S	5/16"x3/8"	145	50	10
7511011S	3/8"x7/16"	152	64	10
7511112S	7/16"x1/2"	165	86	10
7511214S	1/2"x9/16"	178	116	10
7511619S	5/8"x3/4"	210	198	10
7511719S	11/16"x3/4"	210	193	10
7511922S	3/4"x7/8"	233	259	5

**Crowfoot flare nut wrench**

<b>751</b>		<i>l</i>		
Part no.	size	mm	g	pc/box
<b>3/8"DR.</b>				
751310	10	36	35	10
751311	11	36	33	10
751312	12	36	32	10
751313	13	36	30	10
751314	14	42	48	10
751315	15	42	46	10
751316	16	42	44	10
751317	17	47	69	10
751318	18	47	68	10
751319	19	47	64	10
751321	21	50	97	10
751322	22	50	94	10
75133.8	3/8"	36	35	10
75137.16	7/16"	36	33	10
75131.2	1/2"	36	32	10
75139.16	9/16"	42	46	10
75135.8	5/8"	42	44	10
751311.16	11/16"	47	69	10
75133.4	3/4"	47	64	10
751313.16	13/16"	50	97	10
75137.8	7/8"	50	94	10
<b>1/2"DR.</b>				
751423	23	60	146	10
751424	24	60	145	10
751426	26	60	136	10
751415.16	15/16"	60	144	10
75141.0	1"	60	136	10



**Hinged socket wrench**

<b>752</b>		<i>l</i>		
Part no.	size	mm	g	pc/box
7520607	6x7	198	97	10
7520809	8x9	198	99	10
7520810	8x10	201	103	10
7521011	10x11	213	125	10
7521012	10x12	213	128	10
7521213	12x13	227	161	10
7521214	12x14	231	173	10
7521317	13x17	240	228	5
7521415	14x15	243	234	5
7521617	16x17	253	313	5
7521719	17x19	274	374	5
7521819	18x19	277	382	5
7521922	19x22	290	491	5
7522022	20x22	292	520	5
7522123	21x23	292	545	5
7522427	24x27	319	756	5
7523032	30x32	360	1083	5
7521011S	3/8"x7/16"	213	125	10
7521314S	1/2"x9/16"	230	173	10
7521617S	5/8"x11/16"	253	313	5
7521619S	5/8"x3/4"	274	322	5
7521719S	11/16"x3/4"	279	365	5
7521922S	3/4"x7/8"	290	491	5
7522122S	13/16"x7/8"	292	520	5
7522425S	15/16"x1"	319	756	5

**Angle wrench 6pt.-6pt.**

<b>753</b>		<i>l</i>	<i>l</i>		
Part no.	size	short	long	g	pc/box
75306	6	20	102	40	10
75307	7	21	106	52	10
75308	8	28	114	66	10
75309	9	29	122	77	10
75310	10	33	129	96	10
75311	11	36	136	127	10
75312	12	40	144	163	10
75313	13	42	152	200	10
75314	14	45	160	217	5
75315	15	47	169	246	5
75316	16	51	178	315	5
75317	17	53	187	343	5
75318	18	54	195	368	5
75319	19	55	204	466	5
75320	20	59	212	466	5
75321	21	62	221	518	5
75322	22	66	230	574	5
75323	23	69	240	758	5
75324	24	72	250	854	5
75325	25	75	260	915	5
75326	26	77	270	1049	5
75327	27	80	280	1170	5
75328	28	82	290	1314	5
75329	29	84	300	1300	5
75330	30	88	310	1552	5
75332	32	98	330	1718	5





**Angle wrench 12pt.(Short) -6pt.(Long)**

**753...A**

Part no.	size	short	long	g	pc/box
75306A	6	20	102	40	10
75307A	7	21	106	52	10
75308A	8	28	114	66	10
75309A	9	29	122	77	10
75310A	10	33	129	96	10
75311A	11	36	136	127	10
75312A	12	40	144	163	10
75313A	13	42	152	200	10
75314A	14	45	160	217	10
75315A	15	47	169	246	10
75316A	16	51	178	315	5
75317A	17	53	187	343	5
75318A	18	54	195	368	5
75319A	19	55	204	466	5
75320A	20	59	212	466	5
75321A	21	62	221	518	5
75322A	22	66	230	574	5
75323A	23	69	240	758	5
75324A	24	72	250	854	5
75326A	26	77	270	1049	5
75327A	27	80	280	1170	5
75328A	28	82	290	1314	5
75330A	30	88	310	1552	5
75332A	32	98	330	1718	5

**Double open end wrench**

**754**

Part no.	size	mm	g	pc/box
7540507	5x7	123	27	10
7540608	6x8	123	27	10
7540607	6x7	123	27	10
7540809	8x9	141	42	10
7540810	8x10	141	40	10
7541011	10x11	157	63	10
7541012	10x12	157	63	10
7541113	11x13	172	85	10
7541213	12x13	172	83	10
7541214	12x14	180	92	10
7541314	13x14	180	92	10
7541317	13x17	195	99	10
7541415	14x15	190	106	10
7541417	14x17	195	113	10
7541617	16x17	205	142	10
7541618	16x18	205	134	10
7541719	17x19	220	174	5
7541819	18x19	220	175	5
7541921	19x21	236	200	5
7541922	19x22	236	200	5
7542022	20x22	236	223	5
7542123	21x23	246	260	5
7542224	22x24	246	253	5
7542326	23x26	255	279	5
7542426	24x26	255	266	5
7542427	24x27	259	318	5
7542528	25x28	279	322	5
7542730	27x30	286	410	5
7543032	30x32	297	465	5
7543034	30x34	350	608	5
7543236	32x36	350	635	5
7543436	34x36	350	730	5
7543641	36x41	380	950	5
7543842	38x42	380	915	5
7544146	41x46	415	1490	5
7544650	46x50	465	2084	5
7540608S	1/4"x5/16"	123	27	10
7540810S	5/16"x3/8"	141	40	10
7541011S	3/8"x7/16"	157	63	10
7541314S	1/2"x9/16"	180	92	10
7541416S	9/16"x5/8"	190	107	10
7541617S	5/8"x11/16"	195	141	10
7541719S	11/16"x3/4"	220	191	5
7541720S	11/16"x25/32"	228	191	5
7541920S	3/4"x25/32"	228	191	5
7542122S	13/16"x7/8"	236	191	5
7542425S	15/16"x1"	255	308	5
7542427S	15/16"x1-1/16"	259	325	5
7542529S	1"x1-1/8"	279	312	5
7542932S	1-1/8"x1-1/4"	297	478	5



**Combination wrench**

<b>755</b>		<b>l</b>		
Part no.	size	mm	g	pc/box
75503	3	90	13	20
75504	4	96	13	20
75506	6	106	19	10
75507	7	116	22	10
75508	8	126	26	10
75509	9	136	34	10
75510	10	146	43	10
75511	11	156	49	10
75512	12	166	63	10
75513	13	176	72	10
75514	14	186	88	10
75515	15	196	101	10
75516	16	206	108	10
75517	17	216	128	10
75518	18	226	145	10
75519	19	236	167	5
75520	20	246	191	5
75521	21	256	224	5
75522	22	266	226	5
75523	23	276	261	5
75524	24	286	281	5
75525	25	296	310	5
75526	26	306	332	5
75527	27	316	363	5
75528	28	326	402	5
75529	29	336	450	5
75530	30	346	512	5
75532	32	366	522	5
75533	33	385	681	5
75534	34	385	660	5
75535	35	410	824	5
75536	36	410	817	5
75538	38	435	1020	5
75541	41	460	1341	5
75542	42	460	1308	5
75546	46	500	1619	5
75548	48	540	2109	5
75550	50	540	2049	5
75555	55	560	3054	3
75558	58	600	3994	3
75560	60	600	3850	3
75565	65	680	5826	3
75570	70	680	5622	3
7551.4	1/4"	106	17	10
7555.16	5/16"	126	26	10
7553.8	3/8"	146	42	10
7557.16	7/16"	156	49	10
7551.2	1/2"	176	72	10
7559.16	9/16"	186	84	10
7555.8	5/8"	206	113	10
75511.16	11/16"	216	124	10
7553.4	3/4"	236	167	5
75513.16	13/16"	256	229	5
7557.8	7/8"	266	220	5
75515.16	15/16"	286	279	5
7551.0	1"	306	335	5
7551.1.16	1-1/16"	316	375	5
7551.1.8	1-1/8"	346	530	5

<b>755</b>		<b>l</b>		
Part no.	size	mm	g	pc/box
7551.1.4	1-1/4"	366	527	5
7551.5.16	1-5/16"	385	648	5
7551.3.8	1-3/8"	410	822	5
7551.7.16	1-7/16"	435	1112	5
7551.1.2	1-1/2"	435	1081	5
7551.5.8	1-5/8"	460	1354	5
7551.11.16	1-11/16"	460	1291	5
7551.3.4	1-3/4"	500	1750	5
7551.13.16	1-13/16"	500	2100	5
7551.7.8	1-7/8"	540	2100	5
7552.0	2"	540	2200	5







**75°Combination wrench**

<b>755..A</b>		<b>l</b>		
Part no.	size	mm	g	pc/box
75506A	6	130	22	10
75507A	7	130	25	10
75508A	8	140	30	10
75509A	9	150	40	10
75510A	10	160	50	10
75511A	11	170	60	10
75512A	12	180	70	10
75513A	13	190	85	10
75514A	14	200	95	10
75515A	15	210	105	10
75516A	16	220	120	10
75517A	17	230	140	10
75518A	18	240	160	10
75519A	19	250	170	5
75520A	20	260	190	5
75521A	21	270	210	5
75522A	22	280	220	5
75523A	23	290	240	5
75524A	24	300	300	5
75525A	25	310	310	5
75526A	26	315	328	5
75527A	27	325	360	5
75528A	28	335	395	5
75530A	30	355	475	5
75532A	32	375	545	5
7551.4A	1/4"	130	22	10
7555.16A	5/16"	140	30	10
7553.8A	3/8"	160	50	10
7557.16A	7/16"	170	60	10
7551.2A	1/2"	180	70	10
7559.16A	9/16"	200	95	10
7555.8A	5/8"	220	120	10
75511.16A	11/16"	230	140	10
7553.4A	3/4"	250	170	5
75513.16A	13/16"	260	190	5
7557.8A	7/8"	280	220	5
75515.16A	15/16"	300	300	5
7551.0A	1"	310	310	5
7551.1.16A	1-1/16"	325	360	5
7551.1.8A	1-1/8"	335	395	5
7551.1.4A	1-1/4"	375	545	5





**Spline combination wrench**

<b>755..Q</b>									
Part no.	size			SAE		XZN	<i>l</i> mm	 g	 pc/box
75506Q	M6	•	•		E8	6	105	17	10
75507Q	M7	•	•	9/32"		7	115	20	10
75508Q	M8	•	•	5/16"	E10	8	125	25	10
75509Q	M9	•	•	11/32"	E11	9	135	32	10
75510Q	M10	•	•	3/ 8"	E12	10	145	40	10
75511Q	M11	•	•	7/16"	E14	11	155	48	10
75512Q	M12	•	•	15/32"		12	165	58	10
75513Q	M13	•	•	1/ 2"	E16		175	68	10
75514Q	M14	•	•	9/16"	E18	14	185	84	10
75515Q	M15	•	•	19/32"			195	90	10
75516Q	M16	•	•	5/ 8"	E20	16	205	102	10
75517Q	M17	•	•				215	122	10
75518Q	M18	•	•		E22	18	225	128	10
75519Q	M19	•	•	3/ 4"	E24		235	154	5
75520Q	M20	•	•	25/32"		20	245	176	5
75521Q	M21	•	•	13/16"			255	208	5
75522Q	M22	•	•	7/ 8"		22	265	234	5
75523Q	M23	•	•				275	226	5
75524Q	M24	•	•	15/16"		24	285	286	5



**Midget combination wrench**

<b>755S</b>				
Part no.	size	<i>l</i> mm	 g	 pc/box
755S08	8	91	25	10
755S09	9	97	32	10
755S10	10	97	32	10
755S11	11	100	45	10
755S12	12	105	47	10
755S13	13	108	55	10
755S14	14	115	67	10
755S15	15	118	76	10
755S16	16	122	88	10
755S17	17	130	108	10
755S18	18	133	115	10
755S19	19	138	134	10



**Star wrench**

<b>756</b>		<i>l</i>		
Part no.	size	mm	g	pc/box
7560608	E6xE8	112	21	10
7560711	E7xE11	125	34	10
7561012	E10xE12	140	42	10
7561418	E14xE18	180	82	10
7561622	E16xE22	200	129	10
7562024	E20xE24	224	173	10

**Flat gear wrench**

<b>757</b>		<i>l</i>		
Part no.	size	mm	g	pc/box
75708	8	140	36	10
75709	9	150	46	10
75710	10	160	59	10
75711	11	165	69	10
75712	12	170	83	10
75713	13	180	99	10
75714	14	190	122	10
75715	15	200	132	10
75716	16	210	154	10
75717	17	223	181	10
75718	18	233	204	10
75719	19	244	241	10
75720	20	275	330	5
75721	21	275	330	5
75722	22	290	355	5
75723	23	290	355	5
75724	24	290	355	5
7575.16	5/16"	140	36	10
7573.8	3/8"	160	59	10
7577.16	7/16"	165	69	10
7571.2	1/2"	170	83	10
7579.16	9/16"	190	122	10
7575.8	5/8"	210	154	10
75711.16	11/16"	223	181	10
7573.4	3/4"	244	241	10
75713.16	13/16"	290	355	5
7577.8	7/8"	290	355	5
75715.16	15/16"	290	355	5



**Star 75° Offset wrench**

<b>756..A</b>		<i>l</i>		
Part no.	size	mm	g	pc/box
7560608A	E6xE8	145	34	10
7560711A	E7xE11	155	42	10
7561012A	E10xE12	175	51	10
7561418A	E14xE18	215	112	10
7561622A	E16xE22	235	192	5
7562024A	E20xE24	265	224	5



**Star hinged socket wrench**

<b>756...F</b>		<i>l</i>		
Part no.	size	mm	g	pc/box
7560405F	E4xE5	198	83	10
7560607F	E6xE7	198	86	10
7560810F	E8xE10	198	88	10
7561112F	E11xE12	213	116	10
7561416F	E14xE16	227	175	10
7561820F	E18xE20	243	242	5
7562224F	E22xE24	277	424	5



**Flexible gear wrench**

<b>757..F</b>		<i>l</i>		
Part no.	size	mm	g	pc/box
75708F	8	130	50	10
75709F	9	155	73	10
75710F	10	155	73	10
75711F	11	173	99	10
75712F	12	173	99	10
75713F	13	185	116	10
75714F	14	191	133	10
75715F	15	215	198	10
75716F	16	215	198	10
75717F	17	230	223	10
75718F	18	248	276	10
75719F	19	248	276	10





**Reversible gear wrench**

<b>757..R</b>		<b>l</b>		
Part no.	size	mm	g	pc/box
75708R	8	140	43	10
75709R	9	150	51	10
75710R	10	160	66	10
75711R	11	165	72	10
75712R	12	170	83	10
75713R	13	180	106	10
75714R	14	190	126	10
75715R	15	200	142	10
75716R	16	210	158	10
75717R	17	223	196	10
75718R	18	233	219	10
75719R	19	244	263	10
75720R	20	275	330	5
75721R	21	275	330	5
75722R	22	290	355	5
75723R	23	290	355	5
75724R	24	290	355	5
7575.16R	5/16"	140	43	10
7573.8R	3/8"	160	66	10
7577.16R	7/16"	165	72	10
7571.2R	1/2"	170	83	10
7579.16R	9/16"	190	126	10
7575.8R	5/8"	210	158	10
75711.16R	11/16"	223	196	10
7573.4R	3/4"	244	263	10
75713.16R	13/16"	275	330	5
7577.8R	7/8"	290	355	5
75715.16R	15/16"	290	355	5

**45° Offset ring wrench**

<b>758</b>		<b>l</b>		
Part no.	size	mm	g	pc/box
7580607	6x7	165	50	10
7580709	7x9	165	55	10
7580809	8x9	175	60	10
7580810	8x10	185	63	10
7581011	10x11	195	88	10
7581012	10x12	195	90	10
7581113	11x13	205	101	10
7581213	12x13	205	102	10
7581214	12x14	230	99	10
7581415	14x15	235	138	10
7581417	14x17	235	177	10
7581516	15x16	240	180	5
7581617	16x17	240	184	5
7581618	16x18	260	191	5
7581619	16x19	292	200	5
7581719	17x19	250	200	5
7581819	18x19	250	205	5
7581921	19x21	270	211	5
7581922	19x22	270	211	5
7582022	20x22	290	283	5
7582122	21x22	290	283	5
7582123	21x23	290	283	5
7582224	22x24	320	355	5
7582326	23x26	360	470	5
7582426	24x26	360	470	5
7582427	24x27	370	503	5
7582732	27x32	380	610	5
7583032	30x32	380	747	5
7580608S	1/4"x5/16"	168	54	10
7580810S	5/16"x3/8"	183	63	10
7581011S	3/8"x7/16"	198	88	10
7581113S	7/16"x1/2"	217	101	10
7581314S	1/2"x9/16"	217	102	10
7581416S	9/16"x5/8"	239	177	10
7581617S	5/8"x11/16"	260	180	5
7581619S	5/8"x3/4"	292	200	5
7581719S	11/16"x3/4"	292	208	5
7581922S	3/4"x7/8"	318	210	5
7582122S	13/16"x7/8"	326	283	5
7582224S	7/8"x15/16"	326	355	5
7582425S	15/16"x1"	329	355	5
7582527S	1"x1-1/16"	329	355	5
7582932S	1-1/8"x1-1/4"	362	610	5



**Stubby flat gear wrench**

<b>757S</b>	<b>l</b>			
Part no.	size	mm	g	pc/box
757S08	8	92	29	10
757S09	9	92	43	10
757S10	10	94	43	10
757S11	11	105	59	10
757S12	12	105	59	10
757S13	13	105	65	10
757S14	14	115	89	10
757S15	15	120	117	10
757S16	16	120	117	10
757S17	17	125	122	10
757S18	18	138	167	10
757S19	19	138	167	10

**Midget 45° offset ring wrench**

<b>758S</b>		<i>l</i>		
Part no.	size	mm	g	pc/box
758S0708	7x8	115	46	10
758S0809	8x9	115	46	10
758S0810	8x10	115	46	10
758S1011	10x11	115	46	10
758S1012	10x12	115	46	10
758S1213	12x13	140	86	10
758S1214	12x14	140	86	10
758S1314	13x14	140	86	10
758S1415	14x15	140	86	10
758S1417	14x17	157	134	10
758S1617	16x17	157	134	10
758S1618	16x18	157	134	10
758S1619	16x19	157	134	10
758S1719	17x19	157	134	10
758S1819	18x19	157	134	10
758S1011S	3/8"x7/16"	115	46	10
758S1314S	1/2"x9/16"	140	86	10
758S1619S	5/8"x3/4"	157	134	10

**75° Offset ring wrench**

<b>759</b>		<i>l</i>		
Part no.	size	mm	g	pc/box
7590607	6x7	168	53	10
7590608	6x8	168	46	10
7590709	7x9	168	50	10
7590809	8x9	183	64	10
7590810	8x10	183	64	10
7591011	10x11	198	100	10
7591012	10x12	198	101	10
7591213	12x13	217	132	10
7591214	12x14	217	135	10
7591315	13x15	239	150	10
7591415	14x15	239	161	10
7591417	14x17	260	207	10
7591617	16x17	260	206	10
7591618	16x18	260	203	10
7591719	17x19	292	257	5
7591819	18x19	292	258	5

<b>759</b>		<i>l</i>		
Part no.	size	mm	g	pc/box
7591921	19x21	300	311	5
7592022	20x22	318	319	5
7592122	21x22	318	319	5
7592123	21x23	327	388	5
7592224	22x24	327	358	5
7592326	23x26	329	489	5
7592426	24x26	329	492	5
7592427	24x27	329	496	5
7592526	25x26	329	496	5
7592528	25x28	347	536	5
7592627	26x27	347	522	5
7592628	26x28	347	534	5
7592732	27x32	355	612	5
7593032	30x32	362	664	5
7593236	32x36	415	905	5
7593436	34x36	415	908	5
7593641	36x41	450	1141	5
7590608S	1/4"x5/16"	168	47	10
7591011S	3/8"x7/16"	198	91	10
7591314S	1/2"x9/16"	217	131	10
7591617S	5/8"x11/16"	260	188	10
7591619S	5/8"x3/4"	292	193	5
7591922S	3/4"x7/8"	300	309	5
7592122S	13/16"x7/8"	318	310	5
7592224S	7/8"x15/16"	326	372	5
7592425S	15/16"x1"	329	458	5
7592529S	1"x1-1/8"	347	458	5
7592729S	1-1/16"x1-1/8"	347	540	5
7592732S	1-1/16"x1-1/4"	355	651	5
7592932S	1-1/8"x1-1/4"	362	616	5

**Extra-long offset ring wrench**

<b>760</b>		<i>l</i>	
Part no.	Size	mm	g
7600810	8x10	235	87
7601012	10x12	295	124
7601214	12x14	330	200
7601315	13x15	370	333
7601417	14x17	370	333
7601618	16x18	405	458
7601719	17x19	405	447
7602224	22x24	435	602



**Half-moon ring wrench**

<b>761</b>		<i>l</i>		
Part no.	size	mm	g	pc/box
7610810	8x10	141	56	10
7611012	10x12	141	65	10
7611113	11x13	166	104	10
7611214	12x14	166	93	10
7611315	13x15	190	134	10
7611417	14x17	190	141	10
7611618	16x18	220	190	10
7611719	17x19	220	190	10
7611922	19x22	256	240	5



**Bar for double ended socket wrench**

<b>762..</b>	<i>l</i>		
Part no.	mm	g	pc/box
762220	220	80	10
762300	300	280	10

\*762220 only for 7620607 - 7622123 use

\*762300 only for 7622426 - 7623032 use



**S-form ring wrench**

<b>761...A</b>		<i>l</i>		
Part no.	size	mm	g	pc/box
7611012A	10x12	142	56	10
7611113A	11x13	142	56	10
7611415A	14x15	188	100	10
7611618A	16x18	225	164	10
7611719A	17x19	237	198	5
7612224A	22x24	270	296	5
7611113AS	7/16"x1/2"	142	56	10
7611415AS	9/16"x5/8"	188	100	10
7611719AS	11/16"x3/4"	237	198	5
7612224AS	7/8"x15/16"	270	296	5



**Hex key**

<b>764</b>		<i>l</i>	<i>l</i>		
Part no.	Tip	short	long	g	pc/box
7640127	1.27	12	40	2	10
764015	1.5	14	45	2	10
76402	2	16	50	2	10
764025	2.5	18	56	4	10
76403	3	20	63	6	10
764035	3.5	20	63	6	10
76404	4	25	70	10	10
764045	4.5	28	80	10	10
76405	5	28	80	20	10
764055	5.5	30	85	24	10
76406	6	32	90	30	10
76407	7	34	95	44	10
76408	8	36	100	60	10
76409	9	38	105	90	10
76410	10	40	112	105	10
76411	11	45	125	140	10
76412	12	45	125	183	5
76413	13	50	132	207	5
76414	14	56	140	292	5
76416	16	60	160	390	5
76417	17	63	160	527	5
76419	19	70	180	674	5
76422	22	80	200	991	5
76424	24	90	224	1344	5
76427	27	100	250	1770	5



**Double ended 6pt.-6pt. socket wrench**

<b>762</b>		<i>l</i>		
Part no.	size	mm	g	pc/box
7620607	6x7	110	32	10
7620809	8x9	120	48	10
7621011	10x11	130	66	10
7621213	12x13	140	106	10
7621415	14x15	150	138	10
7621617	16x17	160	188	10
7621819	18x19	170	238	10
7622022	20x22	180	262	5
7622123	21x23	185	294	5
7622426	24x26	190	416	5
7622528	25x28	195	442	5
7622729	27x29	200	504	5
7623032	30x32	200	630	5



<b>764</b>		<i>l</i>	<i>l</i>		
Part no.	Tip	short	long	g	pc/box
76430	30	112	280	2372	5
76432	32	125	315	6162	5
76436	36	140	355	4475	5
7641.16	1/16"	14	45	1	10
7645.64	5/64"	16	50	2	10
7643.32	3/32"	18	56	3	10
7641.8	1/8"	20	63	6	10
7645.32	5/32"	25	70	10	10
7643.16	3/16"	28	80	17	10
7641.4	1/4"	32	90	34	10
7645.16	5/16"	36	100	59	10
7643.8	3/8"	40	112	97	10
7647.16	7/16"	45	125	153	10
7641.2	1/2"	50	132	219	5
7649.16	9/16"	55	140	303	5
7645.8	5/8"	60	160	402	5
7643.4	3/4"	70	180	640	5
7647.8	7/8"	80	220	1024	5
7641.0	1"	90	224	1366	5

**Hex long key**

<b>764..L</b>		<i>l</i>	<i>l</i>		
Part no.	Tip	short	long	g	pc/box
7640127L	1.27	14	68	4	10
764015L	1.5	15	74	4	10
76402L	2	16	80	4	10
764025L	2.5	18	87	6	10
76403L	3	20	96	8	10
76404L	4	24	107	14	10
76405L	5	28	120	25	10
76406L	6	32	136	41	10
76407L	7	34	145	68	10
76408L	8	36	154	84	10
76410L	10	40	172	144	10
76412L	12	45	190	299	5
76414L	14	56	210	460	5
76417L	17	63	235	779	5
76419L	19	70	260	1096	5
7641.16L	1/16"	15	74	4	10
7645.64L	5/64"	16	80	4	10
7643.32L	3/32"	18	87	6	10
7641.8L	1/8"	20	96	8	10
7645.32L	5/32"	24	107	14	10
7643.16L	3/16"	28	120	25	10
7641.4L	1/4"	32	136	41	10
7645.16L	5/16"	36	154	84	10
7643.8L	3/8"	40	172	142	10
7641.2L	1/2"	45	190	250	5
7649.16L	9/16"	56	210	355	5
7645.8L	5/8"	63	235	550	5
7643.4L	3/4"	98	260	810	5

**Hex extra long key**

<b>764..XL</b>		<i>l</i>	<i>l</i>		
Part no.	Tip	short	long	g	pc/box
7640127XL	1.27	12	80	4	10
764015XL	1.5	14	90	4	10
76402XL	2	16	100	6	10
764025XL	2.5	18	112	6	10
76403XL	3	20	126	10	10
764035XL	3.5	22	132	12	10
76404XL	4	25	140	18	10
764045XL	4.5	26	150	24	10
76405XL	5	28	160	33	10
764055XL	5.5	30	170	41	10
76406XL	6	32	180	53	10
76407XL	7	34	190	75	10
76408XL	8	36	200	103	10
76409XL	9	38	210	137	10
76410XL	10	40	224	180	10
76411XL	11	40	240	230	10
76412XL	12	45	250	300	5
76413XL	13	50	260	356	5
76414XL	14	56	280	452	5
76416XL	16	58	300	627	5
76417XL	17	63	320	784	5
76419XL	19	70	360	1095	5
7641.16XL	1/16"	14	90	4	10
7645.64XL	5/64"	16	100	4	10
7643.32XL	3/32"	18	112	6	10
7641.8XL	1/8"	20	126	10	10
7645.32XL	5/32"	25	140	18	10
7643.16XL	3/16"	28	160	32	10
7641.4XL	1/4"	32	180	52	10
7645.16XL	5/16"	36	200	104	10
7643.8XL	3/8"	40	224	175	10
7647.16XL	7/16"	40	240	230	10
7641.2XL	1/2"	50	260	356	5
7645.8XL	5/8"	58	300	625	5





**T-shape hex key**

<b>764..T</b>		<i>l</i>	<i>l</i>		
Part no.	Tip	blade	width	g	pc/box
76402T	2	62	125	34	10
764025T	2.5	62	125	34	10
76403T	3	75	150	41	10
764035T	3.5	75	150	42	10
76404T	4	90	180	60	10
764045T	4.5	90	180	69	10
76405T	5	90	180	69	10
76406T	6	105	210	124	10
76407T	7	105	210	133	10
76408T	8	125	250	219	10
76409T	9	140	280	366	10
76410T	10	150	300	405	5
76412T	12	160	320	552	5
76414T	14	170	340	798	5



**Hex ball point long key**

<b>765..L</b>		<i>l</i>	<i>l</i>		
Part no.	Tip	short	long	g	pc/box
7650127L	1.27	14	68	4	10
765015L	1.5	15	74	4	10
76502L	2	16	80	4	10
765025L	2.5	18	87	6	10
76503L	3	20	96	8	10
76504L	4	24	107	14	10
76505L	5	28	120	26	10
76506L	6	32	136	42	10
76507L	7	34	145	68	10
76508L	8	36	154	84	10
76510L	10	40	172	146	10
76512L	12	45	190	230	5
76514L	14	56	210	355	5

<b>765..L</b>		<i>l</i>	<i>l</i>		
Part no.	Tip	short	long	g	pc/box
7651.16L	1/16"	15	74	4	1010
7655.64L	5/64"	16	80	4	10
7653.32L	3/32"	18	87	6	10
7651.8L	1/8"	20	96	8	10
7655.32L	5/32"	24	107	14	10
7653.16L	3/16"	28	120	26	10
7657.32L	7/32"	30	130	38	10
7651.4L	1/4"	32	136	42	10
7655.16L	5/16"	36	154	84	10
7653.8L	3/8"	40	172	142	10
7651.2L	1/2"	45	190	250	5
7659.16L	9/16"	56	210	335	5

**Hex ball point extra long key**

<b>765..XL</b>		<i>l</i>	<i>l</i>		
Part no.	Tip	short	long	g	pc/box
7650127XL	1.27	12	80	4	10
765015XL	1.5	14	90	4	10
76502XL	2	16	100	6	10
765025XL	2.5	18	112	6	10
76503XL	3	20	126	9	10
76504XL	4	25	140	18	10
76505XL	5	28	160	32	10
76506XL	6	32	180	52	10
76508XL	8	36	200	107	10
76510XL	10	40	224	177	10
7651.16XL	1/16"	14	90	4	10
7655.64XL	5/64"	16	100	4	10
7653.32XL	3/32"	18	112	6	10
7651.8XL	1/8"	20	126	10	10
7655.32XL	5/32"	25	140	18	10
7653.16XL	3/16"	28	160	32	10
7651.4XL	1/4"	32	180	52	10
7655.16XL	5/16"	36	200	104	10
7653.8XL	3/8"	40	224	175	10



**Hex ball point grip key**

<b>765..G</b>			<i>l</i>	<i>l</i>		
Part no.	Tip	long	short	g	pc/box	
76502G	2	126	53	18	10	
765025G	2.5	126	53	20	10	
76503G	3	126	53	24	10	
76504G	4	183	68	48	10	
76505G	5	183	68	62	10	
76506G	6	240	82	114	10	
76507G	7	240	82	140	10	
76508G	8	240	82	174	10	
76510G	10	240	82	250	10	
76512G	12	240	82	330	10	
7651.64G	1/64"	126	53	20	10	
7653.32G	3/32"	126	53	24	10	
7651.8G	1/8"	183	68	48	10	
7655.32G	5/32"	183	68	62	10	
7653.16G	3/16"	240	82	114	10	
7651.4G	1/4"	240	82	140	10	
7655.16G	5/16"	240	82	174	10	
7653.8G	3/8"	240	82	250	10	
7651.2G	1/2"	240	82	330	10	

**T-shape star key**

<b>766..T</b>		<i>l</i>	<i>l</i>		
Part no.	Tip	blade	width	g	pc/box
76606T	T6	62	125	20	10
76607T	T7	62	125	20	10
76608T	T8	62	125	20	10
76609T	T9	62	125	20	10
76610T	T10	75	150	25	10
76615T	T15	75	150	25	10
76620T	T20	75	150	25	10
76625T	T25	90	180	60	10
76627T	T27	90	180	60	10
76630T	T30	90	180	62	10
76640T	T40	105	210	135	10
76645T	T45	105	210	138	10
76650T	T50	125	250	220	10
76655T	T55	150	300	450	5
76660T	T60	160	320	650	5



**Star key**



<b>766</b>		<i>l</i>	<i>l</i>		
Part no.	Tip	short	long	g	pc/box
76606	T6	18	64	5	10
76607	T7	19	70	5	10
76608	T8	20	72	6	10
76609	T9	21	75	6	10
76610	T10	21	81	6	10
76615	T15	23	85	11	10
76620	T20	24	89	11	10
76625	T25	24	95	11	10
76627	T27	25	100	13	10
76630	T30	28	112.5	22	10
76640	T40	30	119	31	10
76645	T45	31	128	43	10
76650	T50	34	148	59	10
76655	T55	37	168	107	10
76660	T60	39	185	177	5
76670	T70	43	200	261	5
76680	T80	45	213	370	5

**Star tamperproof grip key**



<b>767..G</b>			<i>l</i>	<i>l</i>		
Part no.	Tip	short	long	g	pc/box	
76710G	T10xT-10H	53	126	22	10	
76715G	T15xT-15H	53	126	26	10	
76720G	T20xT-20H	68	126	30	10	
76725G	T25xT-25H	68	133	46	10	
76727G	T27xT-27H	68	133	52	10	
76730G	T30xT-30H	82	190	96	10	
76740G	T40xT-40H	82	190	116	10	
76745G	T45xT-45H	82	190	140	10	
76750G	T50xT-50H	82	190	166	10	
76755G	T55xT-55H	82	190	196	10	







**Star long key**

<b>766..L</b>		<i>l</i>	<i>l</i>		
Part no.	Tip	short	long	g	pc/box
76606L	T6	18	68	5	10
76607L	T7	18	73	6	10
76608L	T8	18	77	6	10
76609L	T9	18	82	6	10
76610L	T10	19	86	6	10
76615L	T15	21	90	8	10
76620L	T20	23	95	11	10
76625L	T25	25	98	18	10
76627L	T27	26	105	19	10
76630L	T30	29	115	30	10
76640L	T40	33	122	45	10
76645L	T45	36	138	62	10
76650L	T50	40	155	90	10
76655L	T55	45	172	164	10
76660L	T60	52	200	267	5





**Spline key**

<b>768..K</b>		<i>l</i>	<i>l</i>		
Part no.	Tip	short	long	g	pc/box
76805K	M5	26	70	15	10
76806K	M6	31	75	31	10
76808K	M8	36	83	49	10
76810K	M10	41	96	86	10
76812K	M12	47	107	125	10
76814K	M14	52	118	186	5
76816K	M16	61	134	287	5





**Star tamperproof key**

<b>767</b>		<i>l</i>	<i>l</i>		
Part no.	Tip	short	long	g	pc/box
76706	T-6H	18	50	3	10
76707	T-7H	18	50	3	10
76708	T-8H	18	50	3	10
76709	T-9H	18	50	4	10
76710	T-10H	19	53	4	10
76715	T-15H	21	57	6	10
76720	T-20H	23	61	7	10
76725	T-25H	25	65	11	10
76727	T-27H	26	68	12	10
76730	T-30H	29	75	20	10
76740	T-40H	33	83	30	10
76745	T-45H	36	90	42	10
76750	T-50H	40	104	62	10
76755	T-55H	45	118	124	10
76760	T-60H	52	131	186	5

**Star tamperproof long key**

<b>767..L</b>		<i>l</i>	<i>l</i>		
Part no.	Tip	short	long	g	pc/box
76706L	T-6H	18	68	5	10
76707L	T-7H	18	73	6	10
76708L	T-8H	18	77	6	10
76709L	T-9H	18	82	6	10
76710L	T-10H	19	86	6	10
76715L	T-15H	21	90	8	10
76720L	T-20H	23	95	11	10
76725L	T-25H	25	98	18	10
76727L	T-27H	26	105	19	10
76730L	T-30H	29	115	30	10
76740L	T-40H	33	122	45	10
76745L	T-45H	36	138	62	10
76750L	T-50H	40	155	90	10
76755L	T-55H	45	172	164	10
76760L	T-60H	52	200	267	5

**Five-sided star tamperproof L key**

<b>76F</b>		<i>l</i>	<i>l</i>		
Part no.	Tip	short	long	g	pc/box
76F10	TS10	19	53	4	10
76F15	TS15	21	57	6	10
76F20	TS20	223	61	8	10
76F25	TS25	25	65	12	10
76F27	TS27	26	68	12	10
76F30	TS30	29	75	20	10
76F40	TS40	33	83	30	10
76F45	TS45	36	90	42	10
76F50	TS50	40	104	62	10



**Hex nut driver T handle**

<b>774</b>		<i>l</i>	<i>l</i>		
Part no.	Tip	blade	over	g	pc/box
77430004	4	260	300	121	10
774300045	4.5	260	300	122	10
77430005	5	260	300	122	10
774300055	5.5	260	300	127	10
77430006	6	260	300	130	10
77430007	7	260	300	133	10
77430008	8	260	300	137	10
77430009	9	260	300	139	10
77430010	10	260	300	202	10
77430011	11	260	300	202	10
77430012	12	260	300	204	10
77430013	13	260	300	224	10
77430014	14	260	300	270	10
77430017	17	260	300	308	10
7743003.16	3/16"	260	300	122	10
7743001.4	1/4"	260	300	127	10
7743005.16	5/16"	260	300	137	10
7743003.8	3/8"	260	300	202	10
7743007.16	7/16"	260	300	202	10
7743001.2	1/2"	260	300	204	10
7743009.16	9/16"	260	300	270	10
7743005.8	5/8"	260	300	308	10

<b>774..A</b>		<i>l</i>	<i>l</i>		
Part no.	Tip	blade	over	g	pc/box
77413A	13	300	200	346	10
77414A	14	300	200	422	10
77415A	15	300	200	480	10
77416A	16	300	200	510	10
77417A	17	300	200	542	10
77418A	18	300	200	600	10
77419A	19	300	200	620	5
77420A	20	300	200	650	5
77421A	21	300	200	715	5
77422A	22	300	200	715	5
7741.4A	1/4"	300	200	220	10
7745.16A	5/16"	300	200	279	10
7743.8A	3/8"	300	200	294	10
7747.16A	7/16"	300	200	318	10
7741.2A	1/2"	300	200	342	10
7749.16A	9/16"	300	200	422	10
7745.8A	5/8"	300	200	510	10
7743.4A	3/4"	300	200	620	5



**Hex nut driver T handle**

<b>774..A</b>		<i>l</i>	<i>l</i>		
Part no.	Tip	blade	over	g	pc/box
77406A	6	300	200	220	10
77407A	7	300	200	220	10
77408A	8	300	200	279	10
77409A	9	300	200	285	10
77410A	10	300	200	294	10
77411A	11	300	200	318	10
77412A	12	300	200	432	10



**Star nut driver T handle**

<b>776</b>		<i>l</i>	<i>l</i>		
Part no.	Tip	blade	over	g	pc/box
77604	E4	260	300	121	10
77605	E5	260	300	121	10
77606	E6	260	300	123	10
77607	E7	260	300	141	10
77608	E8	260	300	145	10
77610	E10	260	300	148	10
77611	E11	260	300	156	10
77612	E12	260	300	218	10
77614	E14	260	300	237	10
77616	E16	260	300	262	10





**3/8"DR. Universal long nut driver (ball type)**

<b>784..B</b>		<i>l</i>	<i>l</i>	
Part no.	Tip	blade	width	g
784332008B	8	320	200	338
784332010B	10	320	200	338
784332011B	11	320	200	340
784332012B	12	320	200	340
784332013B	13	320	200	340
784332014B	14	320	200	360
784345008B	8	450	200	406
784345010B	10	450	200	406
784345011B	11	450	200	408
784345012B	12	450	200	408
784345013B	13	450	200	408
784345014B	14	450	200	428
784360008B	8	600	200	486
784360010B	10	600	200	486
784360011B	11	600	200	488
784360012B	12	600	200	488
784360013B	13	600	200	488
784360014B	14	600	200	508



**3/8"DR. Universal long nut driver (joint type)**

<b>784..U</b>		<i>l</i>	<i>l</i>	
Part no.	Tip	blade	width	g
784332008U	8	320	200	350
784332010U	10	320	200	350
784332011U	11	320	200	352
784332012U	12	320	200	352
784332013U	13	320	200	352
784332014U	14	320	200	372

<b>784..U</b>		<i>l</i>	<i>l</i>	
Part no.	Tip	blade	width	g
784345008U	8	450	200	418
784345010U	10	450	200	418
784345011U	11	450	200	420
784345012U	12	450	200	420
784345013U	13	450	200	420
784345014U	14	450	200	440
784360008U	8	600	200	498
784360010U	10	600	200	498
784360011U	11	600	200	500
784360012U	12	600	200	500
784360013U	13	600	200	500
784360014U	14	600	200	520



**Universal long nut driver (joint type)**

<b>784..U</b>		<i>l</i>	<i>l</i>	
Part no.	Tip	blade	width	g
<b>1/4"DR.</b>				
784206U	6	400	165	210
784207U	7	400	165	210
784208U	8	400	165	210
784209U	9	450	175	240
<b>3/8"DR.</b>				
784310U	10	450	175	392
784311U	11	450	175	394
784312U	12	450	175	395
784313U	13	450	175	425
784314U	14	500	180	425
784315U	15	500	180	430
784316U	16	500	180	430
784317U	17	500	180	430
<b>1/2"DR.</b>				
784418U	18	500	180	820
784419U	19	500	220	880
784420U	20	500	220	880
784421U	21	500	220	900
784422U	22	500	220	900
784424U	24	500	220	920



**Single open end wrench**

<b>791</b>			
Part no.	size	<i>l</i> mm	 g
79116	16	162	100
79117	17	162	100
79118	18	162	100
79119	19	177	120
79120	20	177	120
79121	21	177	120
79122	22	197	177
79123	23	197	177
79124	24	197	177
79125	25	217	266
79126	26	217	266
79127	27	217	266
79128	28	243	352
79129	29	243	352
79130	30	243	352
79132	32	273	467
79133	33	273	467
79134	34	273	467
79135	35	299	700
79136	36	299	700
79138	38	299	700
79141	41	339	1015
79142	42	339	1015
79143	43	339	1015
79144	44	374	1230
79145	45	374	1230
79146	46	374	1230
79148	48	417	1810
79150	50	417	1810
79155	55	496	2720
79158	58	496	2720
79160	60	496	2720
79165	65	520	1850
79170	70	560	2300
79175	75	600	2800
79180	80	630	3250
79185	85	660	3650
79190	90	680	4800
79195	95	820	5800
791100	100	840	6000

<b>791</b>			
Part no.	size	<i>l</i> mm	 g
7915.8	5/8"	197	177
79111.16	11/16"	197	177
7913.4	3/4"	217	266
79113.16	13/16"	217	266
7917.8	7/8"	243	352
79115.16	15/16"	273	467
7911.0	1"	273	467
7911.1.16	1-1/16"	299	700
7911.1.8	1-1/8"	299	700
7911.1.4	1-1/4"	299	700
7911.5.16	1-5/16"	339	1015
7911.3.8	1-3/8"	339	1015
7911.7.16	1-7/16"	374	1230
7911.1.2	1-1/2"	374	1230
7911.5.8	1-5/8"	417	1810
7911.11.16	1-11/16"	417	1810
7911.3.4	1-3/4"	162	100
7911.13.16	1-13/16"	162	100
7911.7.8	1-7/8"	177	120
7912.0	2"	177	120



**Single ring wrench**

<b>792</b>			
Part no.	size	<i>l</i> mm	 g
79217	17	324	340
79219	19	324	340
79221	21	368	542
79222	22	368	542
79223	23	368	542
79224	24	380	678
79226	26	380	678
79227	27	393	762
79229	29	393	762
79230	30	409	870
79232	32	409	870
79234	34	465	1422
79235	35	465	1422
79236	36	465	1422
79238	38	490	1676
79241	41	490	1676
79243	43	519	2030



<b>792</b>		<b>l</b>	
Part no.	size	mm	g
79244	44	519	2030
79246	46	519	2030
79248	48	594	3100
79250	50	594	3200
79255	55	594	3200
79258	58	616	4860
79260	60	616	4860
79265	65	616	4860

<b>793</b>		<b>l</b>	
Part no.	size	mm	g
79360	60	280	1681
79365	65	300	2050
79370	70	320	3000
79375	75	320	3000
79380	80	350	4000
79385	85	350	4000
79390	90	390	5450
79395	95	390	5450
793100	100	420	6500
793105	105	420	6500
793110	110	450	8500
793115	115	450	8500
793120	120	480	12000
793125	125	480	12000
793130	130	520	13000
793135	135	520	13000
793140	140	520	13000
793145	145	570	19200
793150	150	570	19200
793155	155	570	19200
793160	160	570	19200
793165	165	650	28000
793170	170	650	28000
7931.0	1"	163	242
7931.1.16	1-1/16"	180	340
7931.1.8	1-1/8"	190	416
7931.3.16	1-3/16"	190	416
7931.1.4	1-1/4"	190	416
7931.5.16	1-5/16"	190	416
7931.3.8	1-3/8"	205	518
7931.7.16	1-7/16"	205	518
7931.1.2	1-1/2"	205	518
7931.5.8	1-5/8"	230	735
7931.11.16	1-11/16"	230	735
7931.3.4	1-3/4"	240	930
7931.13.16	1-13/16"	240	930
7931.7.8	1-7/8"	255	1162
7932.0	2"	255	1162



**Slugging wrench**

<b>793</b>		<b>l</b>	
Part no.	size	mm	g
79322	22	163	242
79323	23	163	242
79324	24	163	242
79325	25	163	242
79326	26	180	340
79327	27	180	340
79328	28	180	340
79329	29	190	416
79330	30	190	416
79332	32	190	416
79333	33	190	416
79334	34	205	518
79335	35	205	518
79336	36	205	518
79338	38	205	518
79340	40	230	735
79341	41	230	735
79342	42	230	735
79343	43	230	735
79344	44	240	930
79345	45	240	930
79346	46	240	930
79347	47	240	930
79348	48	255	1162
79350	50	255	1162
79352	52	255	1162
79355	55	270	1362



**Universal long extension (joint type)**

<b>804..U</b>		<i>l</i>	<i>l</i>	
Part no.	Drive	blade	width	g
8042400U	1/4"DR.	400	150	218
8042500U	1/4"DR.	500	150	258
8043320U	3/8"DR.	320	200	318
8043450U	3/8"DR.	450	200	408
8043600U	3/8"DR.	600	200	512
8043700U	3/8"DR.	700	200	582
8044500U	1/2"DR.	500	250	956
8044700U	1/2"DR.	700	250	1252



**Double Socket ratchet wrench**

<b>822..</b>		<i>l</i>		
Part no.	Socket	mm	g	pc/box
8221012	10x12	240	135	5
8221013	10x13	240	135	5
8221014	10x14	240	135	5
8221113	11x13	240	135	5
8221214	12x14	240	135	5
8221317	13x17	280	240	5
8221415	14x15	280	240	5
8221417	14x17	280	240	5
8221419	14x19	315	450	5
8221719	17x19	315	450	5
8221721	17x21	315	450	5
8221722	17x22	315	450	5
8221921	19x21	315	450	5
8221922	19x22	315	450	5
8221923	19x23	360	800	5
8221924	19x24	360	800	5
8222123	21x23	360	800	5
8222126	21x26	360	800	5
8222127	21x27	360	800	5
8222224	22x24	360	800	5
8222326	23x26	360	800	5

<b>822..</b>		<i>l</i>		
Part no.	Socket	mm	g	pc/box
8222427	24x27	360	800	5
8222430	24x30	450	1200	5
8222629	26x29	450	1200	5
8222632	26x32	450	1200	5
8222730	27x30	450	1200	5
8222732	27x32	450	1200	5
8223032	30x32	450	1200	5
8223033	30x33	450	1200	5
8223036	30x36	450	1200	5
8223235	32x35	450	1200	5
8223236	32x36	450	1200	5
8223638	36x38	450	1200	5
8223641	36x41	450	1200	5
8223841	38x41	450	1200	5
8223646	36x46	500	2300	5
8223846	38x46	500	2300	5
8224146	41x46	500	2300	5
8223650	36x50	500	2300	5
8223850	38x50	500	2300	5
8224150	41x50	500	2300	5
8224650	46x50	500	2300	5
8224155	41x55	500	2300	5
8224655	46x55	500	2300	5
8225055	50x55	500	2300	5



**Ratchet ring wrench**

<b>824..</b>		<i>l</i>		
Part no.	Socket	mm	g	pc/box
8240607	6x7	115	64	5
8240809	8x9	135	80	5
8241011	10x11	145	88	5
8241213	12x13	180	168	5
8241415	14x15	180	158	5
8241618	16x18	210	260	5
8241719	17x19	210	252	5
8242122	21x22	305	294	5





**15° Offset ratchet ring wrench**

<b>825..</b>		<i>l</i>		
Part no.	Socket	mm	g	pc/box
8250607	6x7	110	68	5
8250809	8x9	130	83	5
8251011	10x11	140	94	5
8251213	12x13	175	167	5
8251415	14x15	175	165	5
8251618	16x18	205	272	5
8251719	17x19	205	164	5
8252122	21x22	300	303	5



**Double gear flat wrench**

<b>827M..</b>		<i>l</i>		
Part no.	Socket	mm	g	pc/box
827M0809	8x9	135	52	10
827M0810	8x10	135	60	10
827M1011	10x11	145	70	10
827M1213	12x13	165	92	10
827M1415	14x15	180	134	10
827M1618	16x18	205	175	10
827M1719	17x19	225	198	10



**15° Offset ratchet Star ring wrench**

<b>826..</b>		<i>l</i>		
Part no.	Socket	mm	g	pc/box
8260607	E6xE7	110	64	5
8260810	E8xE10	130	88	5
8261112	E11xE12	140	100	5
8261416	E14xE16	175	183	5
8261820	E18xE20	205	260	5
8262224	E22xE24	300	294	5



**Star double gear flat wrench**

<b>828</b>		<i>l</i>		
Part no.	Socket	mm	g	pc/box
8280608	E6xE8	129	56	10
8281012	E10xE12	144	75	10
8281418	E14xE18	180	147	10
8282024	E20xE24	225	208	10



**Double gear flat long wrench**

<b>827..</b>		<i>l</i>		
Part no.	Socket	mm	g	pc/box
8271012	10x12	295	130	10
8271214	12x14	330	178	10
8271315	13x15	370	265	10
8271417	14x17	370	265	10
8271618	16x18	405	357	10
8271719	17x19	405	367	10



**Gear wrench adaptor**

<b>831..</b>		
Part no.	Size	g
831210	1/4" DR. 10mm	10
831313	3/8" DR. 13mm	20
831419	1/2" DR. 19mm	50
831H210	Hex head 1/4" 10mm	9

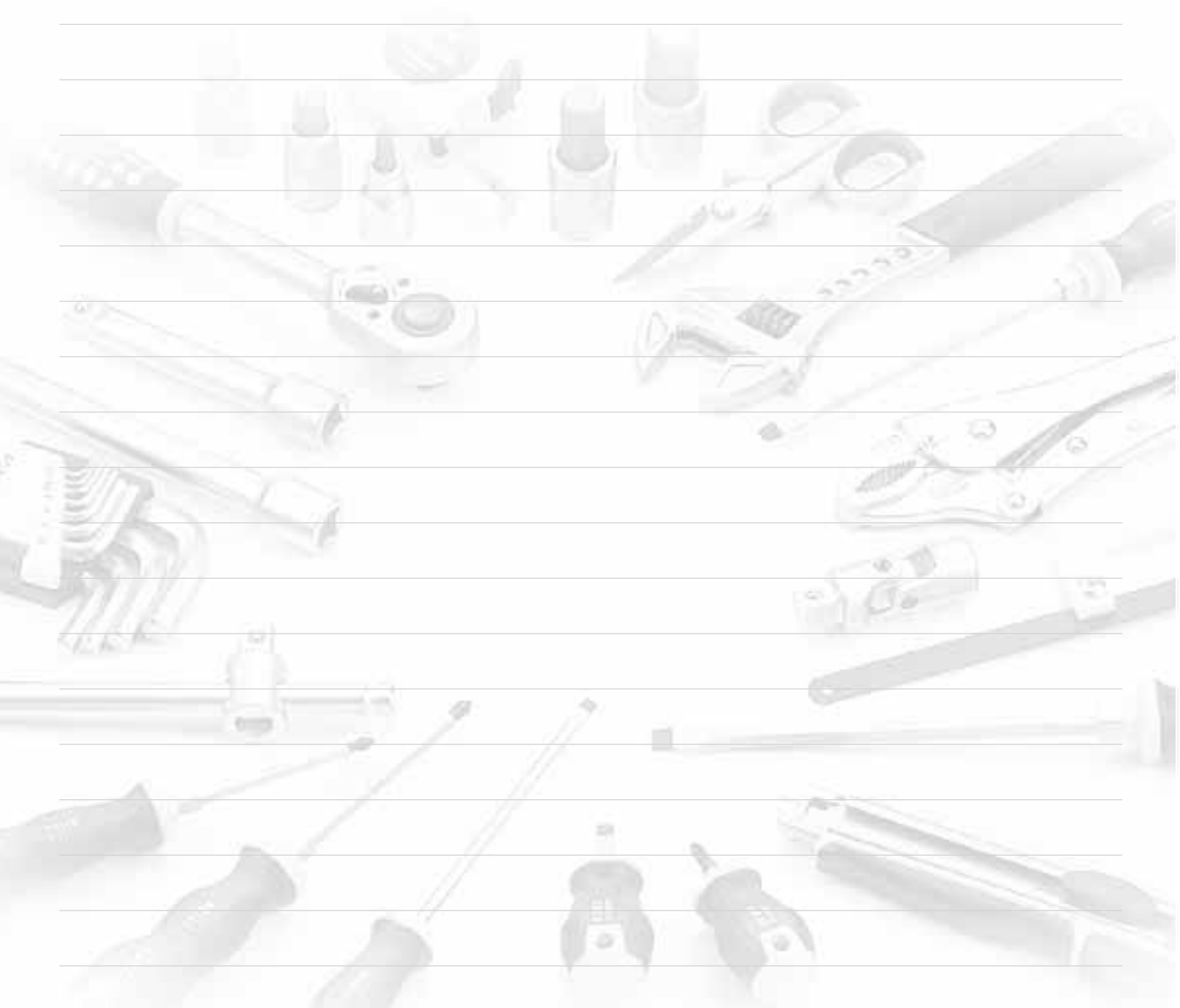



**4pc 1/4" Ratchet handle set**

<b>2045</b>		
Part no.	6/10.7/11.7/0.9'	1220g
	Content: 1/4"DR.	
6472270	1-Torque wrench(tone control)	
802215	1-20 teeth Ratchet handle	
802219	1-20 teeth Stubby ratchet handle	
802218	1-20 teeth Flexible ratchet handle	



**6pc 1/4" Star deep socket set**

<b>2062</b>			
Part no.	Socket	60/10.2/11.2/1.5'	180g
	Content: 1/4"DR.		
52650 04...10	6- Star deep socket E4; E5; E6; E7; E8; E10 (50mmL)		



**4pc 1/4" Ratchet handle set**

<b>2046</b>		
Part no.	6/7.5/8.5/0.66'	1230g
	Content: 1/4"DR.	
6472300W	1-Lock torque wrench - window display (tone control)	
80222	1-24 teeth ratchet handle	
802219	1-20 teeth stubby ratchet handle	
802223	1-72 teeth flexible ratchet handle	



**7pc 1/4" Star tamperproof bit set**

<b>2071</b>			
Part no.	Bit	200/12.0/13.0/1.3'	60g
	Content: 1/4"		
12725 10...40	7- Star tamperproof bit (25mmL) T-10H; T-15H; T-20H; T-25H; T-27H; T-30H; T-40H		



**7pc 1/4" Hex socket bit set (MM)**

<b>2073</b>			
Part no.	Bit	100/15.0/16.0/1.8'	150g
32432 03...10	Content: 1/4"DR. 7- Hex socket bit (32mmL) 3; 4; 5; 6; 7; 8; 10 mm		

**7pc 1/4" Hex socket bit set (SAE)**

<b>2073S</b>			
Part no.	Bit	100/15.0/16.0/1.8'	150g
32432 1.8...3.8	Content: 1/4"DR. 7- Hex socket bit (32mmL) 1/8"; 5/32"; 3/16"; 7/32"; 1/4"; 5/16"; 3/8"		



**8pc 1/4" Bit set**

<b>2081A</b>		
Part no.	100/14.0/15.0/1.5'	140g
12130 1G...3G	Content: 1/4" 3-Phillips bit PH.1; PH.2; PH.3 (30mmL)	
12230 1G...2G	2-Pozidriv bit PZ.1; PZ.2 (30mmL)	
12330 04G...07G	2-Slotted bit 4; 7 mm (30mmL)	
8152105	1-Offset bit holder wrench	



**8pc 1/4" Star tamperproof bit set**

<b>2081</b>			
Part no.	Bit	100/14.0/15.0/1.5'	140g
12730 10G...40G	Content: 1/4" 7-Star tamperproof bit (30mmL) T-10H; T-15H; T-20H; T-25H; T-27H; T-30H; T-40H		
8152105	1-Offset bit holder wrench		



**8pc 1/4" Hex bit set**

<b>2081B</b>			
Part no.	Bit	100/14.0/15.0/1.5'	140g
12430 02G...08G	Content: 1/4" 7-Hex bit 2; 3; 4; 5; 6; 7; 8 mm (30mmL)		
8152105	1-Offset bit holder wrench		



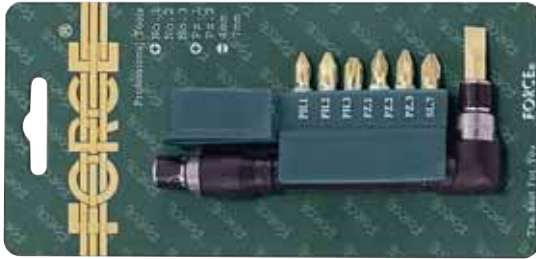

**8pc 1/4" Bit set**

<b>2081C</b>		
Part no.	100/14.0/15.0/1.5'	140g
Content: 1/4"		
12130 1G...3G	3-Phillips bit PH.1; PH.2; PH.3 (30mmL)	
12230 1G...3G	3-Pozidriv bit PZ.1; PZ.2; PZ.3 (30mmL)	
1233007G	1-Slotted bit 7 mm (30mmL)	
8152105	1-Offset bit holder wrench	

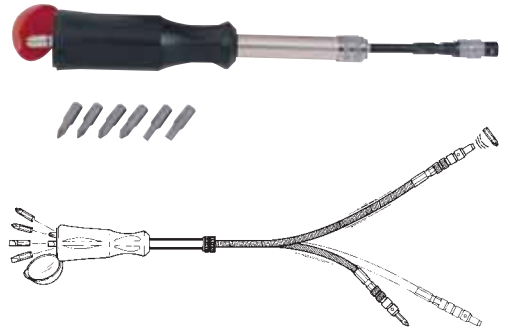

**8pc 1/4" bit set**

<b>2083</b>		
Part no.	60/14.4/15.4/3'	240g
Content: 1/4"		
8146	1-Flexible telescope bit driver	
12125 1...2	2-Phillips bit PH.1; PH.2 (25mmL)	
12225 1...2	2-Pozidriv bit PZ.1; PZ.2 (25mmL)	
12325 04...055	2-Slotted bit 4; 5.5 mm (25mmL)	
8092225M	1-Magnet bit adaptor	



**8pc 1/4" Star bit set**

<b>2081D</b>			
Part no.	Bit	100/14.0/15.0/1.5'	140g
Content: 1/4"			
12630 10...40G	7-Star bit T10; T15; T20; T25; T27; T30; T40 (30mmL)		
8152105	1-Offset bit holder wrench		



**10pc Phillips bit set**



<b>2101</b>			
Part no.	Bit	100/11.6/12.6/0.8'	116g
Content: 1/4"			
121452D	10- Double end phillips bit PH.2 (45mmL)		

**10pc Phillips long bit set**

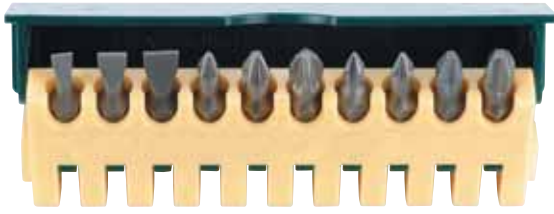
<b>2101L</b>			
Part no.	Bit	100/11.6/12.6/0.8'	116g
Content: 1/4"			
121652D	10- Double end phillips long bit PH.2 (65mmL)		



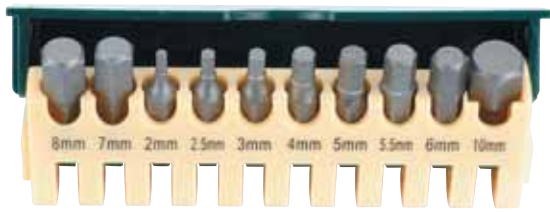

**10pc 1/4" Bit set**

<b>21010</b>		
Part no.	100/10.0/11.0/0.9'	100g
12125 0...3	Content: 4-1/4" Phillips bit (25mmL) PH.0; PH.1; PH.2; PH.3	
12225 1...3	3-1/4" Pozidriv bit (25mmL) PZ.1; PZ.2; PZ.3	
12325 04...065	3-1/4" Slotted bit (25mmL) 4; 5.5; 6.5 mm	





**10pc 1/4" Hex bit set**

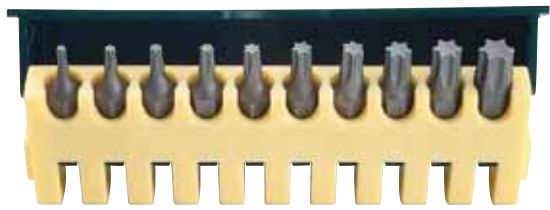

<b>21011</b>			
Part no.	Bit	100/10.0/11.0/0.9'	100g
12425 02...10	Content: 10-1/4" Hex bit (25mmL) 2; 2.5; 3; 4; 5; 5.5; 6; 7; 8; 10 mm		



**10pc 1/4" Star bit set**



<b>21012</b>			
Part no.	Bit	100/10.0/11.0/0.9'	100g
12625 07...40	Content: 10-1/4" Star bit (25mmL) T7; T8; T9; T10; T15; T20; T25; T27; T30; T40		

**10pc 1/4" Star tamperproof bit set**

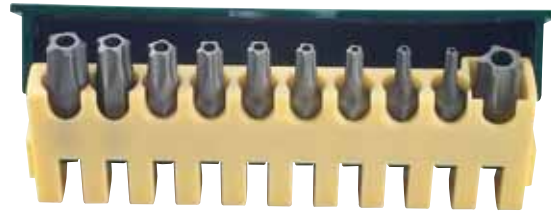
<b>21012T</b>			
Part no.	Bit	100/10.0/11.0/0.9'	100g
12725 07...40	Content: 10-1/4" Star tamperproof bit (25mmL) T-7H; T-8H; T-9H; T-10H; T-15H; T-20H; T-25H; T-27H; T-30H; T-40H		





**10pc 1/4" 5-Sided star tamperproof bit set**



<b>21013</b>			
Part no.	Bit	100/10.0/11.0/0.9'	100g
12F25 08...50	Content: 10-1/4" 5-Sided star tamperproof bit (25mmL) TS08; TS10; TS15; TS20; TS25; TS27; TS30; TS40; TS45; TS50		



**11pc Star socket bit set**

<b>2111I</b>			
Part no.	Bit	48/20.5/21.5/1.4'	428g
32632 10...30	Content: 1/4" & 3/8" DR. 6-1/4" DR. Star socket bit (32mmL) T10; T15; T20; T25; T27; T30		
33650 40...60	5-3/8" DR. Star socket bit (50mmL) T40; T45; T50; T55; T60		

**11pc Star tamperproof socket bit set**

<b>2112I</b>			
Part no.	Bit	48/20.5/21.5/1.4'	428g
32732 10...30	Content: 1/4" & 3/8" DR. 6-1/4" DR. Star tamperproof socket bit (32mmL) T-10H; T-15H; T-20H; T-25H; T-27H; T-30H		
33750 40...60	5-3/8" DR. Star tamperproof socket bit (50mmL) T-40H; T-45H; T-50H; T-55H; T-60H		



**11pc 1/4" 12pt. Flank socket set (SAE)**

<b>21110</b>			
Part no.	Socket	48/20.5/21.5/1.4'	250g
529 5.32...9.16	Content: 1/4"DR. 11- 1/4" 12pt. Flank socket 5/32"; 3/16"; 7/32"; 1/4"; 9/32"; 5/16"; 11/32"; 3/8"; 7/16"; 1/2"; 9/16"		



**11pc 1/4" Bit set**

<b>21112</b>		
Part no.	100/15.5/16.5/0.9'	145g
12125 1...3	Content: 1/4" DR. 4-Phillips bit PH.1; PH.2; PH.2; PH.3 (25mmL)	
12225 1...3	4-Pozidriv bit PZ.1; PZ.2; PZ.2; PZ.3 (25mmL)	
12325 055...065	2-Slotted bit 5.5; 6.5 mm (25mmL)	
81260Q	1-Magnetic quick-release holder	



**11pc 1/4" Bit set**

<b>21111</b>		
Part no.	100/15.5/16.5/0.9'	145g
12125 0...3	Content: 1/4" DR. 4-Phillips bit PH.0; PH.1; PH.2; PH.3 (25mmL)	
12225 0...3	4-Pozidriv bit PZ.0; PZ.1; PZ.2; PZ.3 (25mmL)	
12325 055...065	2-Slotted bit 5.5; 6.5 mm (25mmL)	
81260Q	1-Magnetic quick-release holder	



**11pc 1/4" Star bit set**



<b>21113</b>			
Part no.	Bit	100/15.5/16.5/0.9'	145g
12625 07...40	Content: 1/4" DR. 10-1/4" Star bit (25mmL) T7; T8; T9; T10; T15; T20; T25; T27; T30; T40		
81260Q	1-Magnetic quick-release holder		

**11pc 1/4" Star tamperproof bit set**

<b>21113T</b>			
Part no.	Bit	100/15.5/16.5/0.9'	145g
12725 07...40	Content: 1/4" DR. 10-1/4" Star tamperproof bit (25mmL) T-7H; T-8H; T-9H; T-10H; T-15H; T-20H; T-25H; T-27H; T-30H; T-40H		
81260Q	1-Magnetic quick-release holder		





**13pc 1/4" 12pt. Flank socket set**

<b>2133</b>			
Part no.	Socket	48/12.0/13.0/1.4'	270g
529 04...14	Content: 1/4" DR. 13-1/4" 12pt. Flank socket 4; 4.5; 5; 5.5; 6; 7; 8; 9; 10; 11; 12; 13; 14 mm		









**19pc 1/4" Socket set**

<b>2203</b>			
Part no.	Socket	15/14.0/15.0/1'	934g
527 04...14	Content: 1/4" DR. 13-Surface drive socket 4; 4.5; 5; 5.5; 6; 7; 8; 9; 10; 11; 12; 13; 14 mm		
80222	1-Ratchet handle		
8042 050...150	2-Extension bar 2"; 6"		
80521	1-Universal joint		
8032115	1-Sliding T handle		
8145	1-Spinner		





**13pc Spline deep socket set**

<b>2138Q</b>			
Part no.	Socket	48/21.0/22.0/1.2'	438g
52Q50 04...14	Content: 1/4" DR. 13-1/4" Spline deep socket (50mmL) 4; 4.5; 5; 5.5; 6; 7; 8; 9; 10; 11; 12; 13; 14 mm		

<b>2203-5</b>			
Part no.	Socket	15/14.0/15.0/1'	934g
Changed Items 525 04...14	Content: 1/4" DR. 13-6pt. Flank socket 4; 4.5; 5; 5.5; 6; 7; 8; 9; 10; 11; 12; 13; 14 mm		





**14pc Spline socket set**

<b>2144Q</b>			
Part no.	Socket	48/11.0/12.0/1.1'	230g
52Q 032...14	Content: 1/4" DR. 14- 1/4" Spline socket 3.2; 4; 4.5; 5; 5.5; 6; 7; 8; 9; 10; 11; 12; 13; 14 mm		











**19pc 1/4" Socket set**

<b>2203-72</b>			
Part no.	Socket	15/14.0/15.0/1'	934g
527 04...14	Content: 1/4" DR. 13-Surface drive socket 4; 4.5; 5; 5.5; 6; 7; 8; 9; 10; 11; 12; 13; 14 mm		
80229	1-72 teeth ratchet handle		
8042 050...150	2-Extension bar 2"; 6"		
80521	1-Universal joint		
8032115	1-Sliding T handle		
8145	1-Spinner		

**24pc 1/4" Socket set**



<b>2253</b>			
Part no.	Socket	15/19.3/20.3/1'	1287g
525 04...13	Content: 1/4" DR. 11-6pt. Flank socket 4; 5; 5.5; 6; 7; 8; 9; 10; 11; 12; 13 mm		
52550 05...13	9-6pt. Flank deep socket 5; 6; 7; 8; 9; 10; 11; 12; 13 mm		
80225	1-Ratchet handle		
8042 050...150	2-Extension bar 2"; 6"		
8143	1-Spinner		

**2203-72-5**



<b>2203-72-5</b>			
Part no.	Socket	15/14.0/15.0/1'	934g
Changed Items 525 04...14	Content: 1/4" DR. 13-6pt. Flank socket 4; 4.5; 5; 5.5; 6; 7; 8; 9; 10; 11; 12; 13; 14 mm		





**24pc 1/4" Socket set**

<b>2253-72</b>			
Part no.	Socket	15/19.3/20.3/1'	1287g
	Content: 1/4" DR.		
525 04...13	11-6pt. Flank socket 4; 5; 5.5; 6; 7; 8; 9; 10; 11; 12; 13 mm		
52550 05...13	9-6pt. Flank deep socket 5; 6; 7; 8; 9; 10; 11; 12; 13 mm		
80229	1-72 teeth ratchet handle		
8042 050...150	2-Extension bar 2"; 6"		
8143	1-Spinner		

**27pc 1/4" Socket combination set**



<b>2281</b>			
Part no.	Socket	15/17.3/18.3/1'	1154g
	Content: 1/4" DR.		
529 04...14	11-12pt. Flank socket 4; 5; 6; 7; 8; 9; 10; 11; 12; 13; 14 mm		
32432 03...06	10-Socket bit (32mmL) Hex 3; 4; 5; 6 mm		
32332 04...07	Slotted 4; 5.5; 7 mm		
32132 1...3	Phillips PH.1; PH.2; PH.3		
80222	1-Ratchet handle		
8042 050...150	2-Extension bar 2"; 6"		
8032115	1-Sliding T handle		
80521	1-Universal joint		
8143	1-Spinner		



**2281-5**

<b>2281-5</b>			
Part no.	Socket	15/17.3/18.3/1'	1154g
Changed Items	Content: 1/4" DR.		
525 04...14	11-6pt. Flank socket 4; 5; 6; 7; 8; 9; 10; 11; 12; 13; 14 mm		





**27pc 1/4" Socket combination set**



<b>2281-72</b>			
Part no.	Socket	15/17.3/18.3/1'	1154g
529 04...14	Content: 1/4" DR. 11-12pt. Flank socket 4; 5; 6; 7; 8; 9; 10; 11; 12; 13; 14 mm		
32432 03...06	10-Socket bit (32mmL) Hex 3; 4; 5; 6 mm		
32332 04...07	Slotted 4; 5.5; 7 mm		
32132 1...3	Phillips PH.1; PH.2; PH.3		
80229	1-72 teeth ratchet handle		
8042 050...150	2-Extension bar 2"; 6"		
8032115	1-Sliding T handle		
80521	1-Universal joint		
8143	1-Spinner		



<b>2281-72-5</b>			
Part no.	Socket	15/17.3/18.3/1'	1154g
Changed Items 525 04...14	Content: 1/4" DR. 11-6pt. Flank socket 4; 5; 6; 7; 8; 9; 10; 11; 12; 13; 14 mm		



**29pc 1/4" Socket combination set**



<b>2292</b>			
Part no.	Socket	20/16.0/17.0/1'	800g
525 04...13	Content: 1/4" DR. 12-6pt. Flank socket 4; 4.5; 5; 5.5; 6; 7; 8; 9; 10; 11; 12; 13 mm		
324 03...08	12-Socket bit 25mmL (one-piece) Hex 3; 4; 5; 6; 8 mm		
323 04...07	Slotted 4; 5.5; 7 mm		
321 01...2	Phillips PH.1; PH.2		
322 01...2	Poqidriv PZ.1; PZ.2		
80222	1-Ratchet handle		
8032115	1-Sliding T handle		
8042050	1-Extension bar 2"		
80521	1-Universal joint		
8143	1-Spinner 6"		

<b>2292-7</b>			
Part no.	Socket	20/16.0/17.0/1'	800g
Changed Items 527 04...13	Content: 1/4" DR. 12- Surface drive socket 4; 4.5; 5; 5.5; 6; 7; 8; 9; 10; 11; 12; 13 mm		



<b>2292-9</b>			
Part no.	Socket	20/16.0/17.0/1'	800g
Changed Items 529 04...13	Content: 1/4" DR. 12-12pt. Flank socket 4; 4.5; 5; 5.5; 6; 7; 8; 9; 10; 11; 12; 13 mm		



**29pc 1/4" Star set**

<b>2303</b>			
Part no.	Socket	10/16.5/17.5/0.7'	1650g
	Content: 1/4" & 3/8" & 1/2" DR.		
	10-Star socket		
526 05...08	1/4"DR.: E5; E6; E7; E8		
536 10...14	3/8"DR.: E10; E12; E14		
546 16...20	1/2"DR.: E16; E18; E20		
12625 10...30	5-1/4" Star bit (25mmL) T10; T20; T25; T27; T30		
15635 40...50	3-5/16" Star bit (35mmL) T40; T45; T50		
346055 55...60	2-1/2"DR. Star socket bit T55; T60 (55mmL)		
1266525	1-1/4" Star bit T25 (65mmL)		
1273030	1-1/4" Star tamperproof bit T-30H (30mmL)		
756 0608...2024	4-Star wrench E6xE8; E10xE12; E14xE18; E20xE24		
81022	1-Bit holder 1/4"DR.x1/4"		
81035	1-Bit holder 3/8"DR.x5/16"		
81045	1-Bit holder 1/2"DR.x5/16"		



**30pc 1/4" Security bit set**

<b>2304</b>		
Part no.	20/10.5/11.5/1'	525g
	Content: 1/4" DR.	
8147	1-Magnetic bit holder spinner	
	26-1/4" Security bit (25mmL)	
121S25 06...10	Torq set 6; 8; 10	
122S25 01...04	Tri-wing 1; 2; 3; 4	
123S25 04...10	Spanner 4; 6; 8; 10	
124S25	Hex security 5/32"; 9/64"; 1/8"; 7/64"; 3/32"; 5/64"	
5.32...5.64		
12725 08...40	Star tamperproof T-8H; T-10H; T-15H; T-20H; T-25H; T-27H; T-30H; T-35H; T-40H	
81022U	1-U spring bit holder 1/4"(F)x1/4"(F)	
8092225	1-Bit adaptor 25mmL	











**31pc 1/4" Socket set**

<b>2312</b>			
Part no.	Socket	15/19.3/20.3/1'	1360g
529 04...14	Content: 1/4" DR. 13-12pt. Flank socket (MM) 4; 4.5; 5; 5.5; 6; 7; 8; 9; 10; 11; 12; 13; 14 mm		
529 3.16...9.16	10-12pt. Flank socket (SAE) 3/16"; 7/32"; 1/4"; 9/32"; 5/16"; 11/32"; 3/8"; 7/16"; 1/2"; 9/16"		
80222	1-Ratchet handle		
8042 050...150	2-Extension bar 2"; 6"		
80622	1-Adaptor for extension 1/4"(F)x1/4"(M)		
80521	1-Universal joint		
8145	1-Spinner		
81022	1-Bit holder 1/4"DR.x1/4"		
8111	1-Flexible extension		



**31pc 1/4" Socket set**

<b>2312-72</b>			
Part no.	Socket	15/19.3/20.3/1'	1360g
529 04...14	Content: 1/4" DR. 13-12pt. Flank socket (MM) 4; 4.5; 5; 5.5; 6; 7; 8; 9; 10; 11; 12; 13; 14 mm		
529 3.16...9.16	10-12pt. Flank socket (SAE) 3/16"; 7/32"; 1/4"; 9/32"; 5/16"; 11/32"; 3/8"; 7/16"; 1/2"; 9/16"		
80229	1-72 teeth ratchet handle		
8042 050...150	2-Extension bar 2"; 6"		
80622	1-Adaptor for extension 1/4"(F)x1/4"(M)		
80521	1-Universal joint		
8145	1-Spinner		
81022	1-Bit holder 1/4"DR.x1/4"		
8111	1-Flexible extension		



**2312-5**



			
Part no.	Socket	15/19.3/20.3/1'	1360g
Changed Items	Content: 1/4" DR.		
525 04...14	13- 6pt. Flank socket (MM) 4; 4.5; 5; 5.5; 6; 7; 8; 9; 10; 11; 12; 13; 14 mm		
525 3.16...9.16	10- 6pt. Flank socket (SAE) 3/16"; 7/32"; 1/4"; 9/32"; 5/16"; 11/32"; 3/8"; 7/16"; 1/2"; 9/16"		

**2312-72-5**



			
Part no.	Socket	15/19.3/20.3/1'	1360g
Changed Items	Content: 1/4" DR.		
525 04...14	13- 6pt. Flank socket (MM) 4; 4.5; 5; 5.5; 6; 7; 8; 9; 10; 11; 12; 13; 14 mm		
525 3.16...9.16	10- 6pt. Flank socket (SAE) 3/16"; 7/32"; 1/4"; 9/32"; 5/16"; 11/32"; 3/8"; 7/16"; 1/2"; 9/16"		



31pc 1/4" Bit set		
<b>2313</b>		
Part no.	48/14.4/15.4/1.2'	300g
Content: 1/4"		
12125 0...3	6-1/4" Phillips bit (25mmL) PH.0 x 1pc; PH.1 x 2pc; PH.2 x 2pc; PH.3 x 1pc	
12225 1...3	5-1/4" Pozidriv bit (25mmL) PZ.1 x 2pc; PZ.2 x 2pc; PZ.3 x 1pc	
12325 055...065	3-1/4" Slotted bit 4; 5.5; 6.5 mm (25mmL)	
12425 03...06	4-1/4" Hex bit 3; 4; 5; 6 mm (25mmL)	
12625 05...40	12-1/4" Star bit T5; T6; T7; T8; T9; T10; T15; T20; T25; T27; T30; T40 (25mmL)	
81260Q	1-Magnetic quick-release holder	



31pc 1/4" Bit set		
<b>2314A</b>		
Part no.	48/14.4/15.4/1.2'	300g
Content: 1/4"		
12125 1...3	10-1/4" Phillips bit (25mmL) PH.1 x 2pc; PH.2 x 5pc; PH.3 x 3pc	
12225 1...3	10-1/4" Pozidriv bit (25mmL) PZ.1 x 2pc; PZ.2 x 5pc; PZ.3 x 3pc	
12325 04...065	10-1/4" Slotted bit (25mmL) 4 x 2pc; 5.5 x 5pc; 6.5 x 3pc	
81260Q	1-Magnetic quick-release holder	



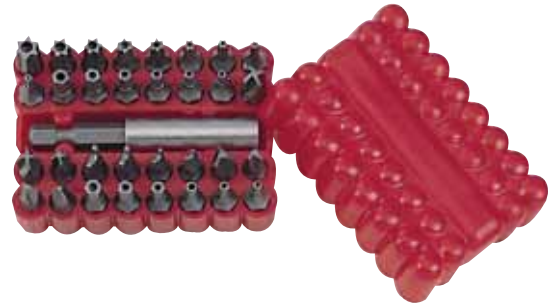

31pc 1/4" Bit set		
<b>2314B</b>		
Part no.	48/14.4/15.4/1.2'	300g
Content: 1/4"		
12125 1...3	10-1/4" Phillips bit (25mmL) PH.1 x 2pc; PH.2 x 5pc; PH.3 x 3pc	
12225 1...3	10-1/4" Pozidriv bit (25mmL) PZ.1 x 2pc; PZ.2 x 5pc; PZ.3 x 3pc	
12325 04...065	10-1/4" Slotted bit (25mmL) 4 x 2pc; 5.5 x 5pc; 6.5 x 3pc	
81280Q	1-Magnetic quick-release holder with screw steady * 81280Q with a second magnet to keep screws always straight and centered.	



**31pc 1/4" Bit set**



<b>2315</b>		
Part no.	48/14.4/15.4/1.2'	300g
	Content: 1/4"	
121S25 06...1.4	4-1/4" Torq set bit (25mmL) 6; 8; 10; mm 1/4"	
122S25 01...03	3-1/4" Tri-wing bit (25mmL) PH.1; PH.2; PH.3	
123S25 04...10	4-1/4" Spanner bit (25mmL) 4; 6; 8; 10 mm	
124S25 02...06	6-1/4" Hex security bit (25mmL) 2; 2.5; 3; 4; 5; 6 mm	
12725 07...40	9-1/4" Star tamperproof bit (25mmL) T-7H; T-8H; T-10H; T-15H; T-20H; T-25H; T-27H; T-30H; T-40H	
124R25 0...3	4-1/4" Square bit (25mmL) No.0; No.1; No.2; No.3	
81260Q	1-Magnetic quick-release holder	

**33pc 1/4" Security bit set**



<b>2331</b>		
Part no.	80/20.0/21.0/1.6'	250g
	Content: 1/4"	
81260	1-Magnetic bit holder (60mmL)	
	32-1/4" Security bit (25mmL)	
121S25 06...10	Torq set 6; 8; 10	
122S25 01...04	Tri-wing 1; 2; 3; 4	
123S25 04...10	Spanner 4; 6; 8; 10	
124S25 02...06	Hex security 2; 2.5; 3; 4; 5; 6 mm	
124S25 5.32...5.64	5/32"; 9/64"; 1/8"; 7/64"; 3/32"; 5/64"	
12725 08...40	Star tamperproof T-8H; T-10H; T-15H; T-20H; T-25H; T-27H; T-30H; T-35H; T-40H	



**40pc 1/4" Socket set**

<b>2402</b>			
Part no.	Socket	10/20.0/21.0/1'	2000g
	Content: 1/4" DR.		
525 04...13	18-6pt. Flank socket	4; 4.5; 5; 5.5; 6; 7; 8; 9; 10; 11; 12; 13 mm	
525 3.16...1.2		3/16"; 1/4"; 9/32"; 11/32"; 3/8"; 1/2"	
	14-6pt. Flank deep socket		
52550 04...13		4; 5; 5.5; 6; 7; 8; 9; 10; 11; 13 mm	
52550 3.16...1.2		3/16"; 1/4"; 3/8"; 1/2"	
80225	1-Ratchet handle		
8042 050...150	3-Extension bar 2"; 4"; 6"		
8111	1-Flexible extension		
8032115	1-Sliding T handle		
80521	1-Universal joint		
8143	1-Spinner		



**40pc 1/4" Spline combination set**

<b>2405Q</b>			
Part no.	Socket	15/14.5/15.5/1'	967g
	Content: 1/4" DR.		
52Q 04...14	13-Spline socket	4; 4.5; 5; 5.5; 6; 7; 8; 9; 10; 11; 12; 13; 14 mm	
	22-1/4" bit (25mmL)		
12125 1...2	Phillips PH.1; PH.2		
12225 1...2	Pozidriv PZ.1; PZ.2		
12425 03...08	Hex 3; 4; 5; 6; 7; 8 mm		
12625 10...40	Star T10; T15; T20; T25; T27; T30; T40		
12825 04...10	Spline M4; M5; M6; M8; M10		
80222	1-Ratchet handle		
8042100	1-Extension bar (100mmL)		
80521	1-Universal joint		
81022	1-Bit holder 1/4"(F)x1/4"(F)		
8143	1-Spinner 6"		











**40pc 1/4" Socket combination set**

<b>2411</b>			
Part no.	Socket	10/17.0/18.0/0.9'	1700g
	Content: 1/4" DR.		
529 04...13	10-12pt. Flank socket	4; 5; 5.5; 6; 7; 8; 10; 11; 12; 13 mm	
52950 07...10	3-12pt. Flank deep socket	7; 8; 10 mm (50mmL)	
	16-Socket bit (32mmL)		
32432 03...06	Hex 3; 4; 5; 6 mm		
32632 10...40	Star T10; T20; T25; T27; T30; T40		
32332 04...07	Slotted 0.8x4; 1.0x5.5; 1.2x7 mm		
32132 1...3	Phillips PH.1; PH.2; PH.3		
80222	1-Ratchet handle		
8042 050...150	2-Extension bar 2"; 6"		
8111	1-Flexible extension 6"		
80521	1-Universal joint		
8142	1-Spinner		
80622	1-Adaptor for extension	1/4"(F)x1/4"(M)	
764-4	4-Hex key 1.27; 1.5; 2; 2.5 mm		

**42pc 1/4" Socket combination set**

<b>2421</b>			
Part no.	Socket	20/18.0/19.0/0.82	900g
	Content: 1/4" DR.		
525 032...14	14-6pt. Flank socket	3.2; 4; 4.5; 5; 5.5; 6; 7; 8; 9; 10; 11; 12; 13; 14 mm	
	20-1/4" bit (25mmL)		
12425 03...08	Hex 3, 4, 5, 6, 8 mm		
12625 10...40	Star T10, T15, T20, T25, T30, T40		
12325 04...065	Slotted 4, 5.5, 6.5 mm		
12125 1...3	Phillips PH.1, PH.2, PH.3		
12225 1...3	Pozidriv PZ.1, PZ.2, PZ.3		
80229	1-72 teeth ratchet handle		
8042 050...150	2-Extension bar 2"; 6"		
80521	1-Universal joint		
81022	1-Bit holder 1/4"(F)x1/4"(F)		
8143	1-Spinner		
80632	1-Adaptor for extension	3/8"(F)x1/4"(M)	
81225	1-Magnetic socket pick up		

**2411-5**

<b>2411-5</b>			
Part no.	Socket	10/17.0/18.0/0.9'	1700g
Changed Items	Content: 1/4" DR.		
525 04...13	10-6pt. Flank socket	4; 5; 5.5; 6; 7; 8; 10; 11; 12; 13 mm	
52550 07...10	3-6pt. Flank deep socket	7; 8; 10 mm (50mmL)	

**42pc 1/4" Socket combination set**
**2421F**



Part no.	Socket	20/18.0/19.0/0.82	900g
	Content: 1/4" DR.		
525 032...14	14-6pt. Flank socket	3.2; 4; 4.5; 5; 5.5; 6; 7; 8; 9; 10; 11; 12; 13; 14 mm	
	20-1/4" bit (25mmL)		
12425 03...08	Hex 3, 4, 5, 6, 8 mm		
12625 10...40	Star T10, T15, T20, T25, T30, T40		
12325 04...065	Slotted 4, 5.5, 6.5 mm		
12125 1...3	Phillips PH.1, PH.2, PH.3		
12225 1...3	Pozidriv PZ.1, PZ.2, PZ.3		
802218	1-Flexible ratchet handle		
8042 050...150	2-Extension bar 2"; 6"		
80521	1-Universal joint		
81022	1-Bit holder 1/4"(F)x1/4"(F)		
8143	1-Spinner		
80632	1-Adaptor for extension	3/8"(F)x1/4"(M)	
81225	1-Magnetic socket pick up		



**42pc 1/4" Socket combination set**
**2421BF**

Part no.	Socket	20/18.0/19.0/0.82	900g
	Content: 1/4" DR.		
525 032...14	14-6pt. Flank socket	3.2; 4; 4.5; 5; 5.5; 6; 7; 8; 9; 10; 11; 12; 13; 14 mm	
	20-1/4" bit (25mmL)		
12425 03...08	Hex 3, 4, 5, 6, 8 mm		
12625 10...40	Star T10, T15, T20, T25, T30, T40		
12325 04...065	Slotted 4, 5.5, 6.5 mm		
12125 1...3	Phillips PH.1, PH.2, PH.3		
12225 1...3	Pozidriv PZ.1, PZ.2, PZ.3		
802202F	1-Flexible bit ratchet for 1/4" inhex		
8042 050...150	2-Extension bar 2"; 6"		
80521	1-Universal joint		
8092225	1-Bit adaptor 1/4"Hex-1/4"Sq.		
8143	1-Spinner		
80632	1-Adaptor for extension	3/8"(F)x1/4"(M)	
81225	1-Magnetic socket pick up		









**46pc 1/4" Socket combination set**



<b>2461</b>			
Part no.	Socket	10/18.0/19.0/1.3'	1800g
Content: 1/4" DR.			
527 04...14	13-Surface drive socket	4; 4.5; 5; 5.5; 6; 7; 8; 9; 10; 11; 12; 13; 14 mm	
52750 08...13	4-Surface drive deep socket	8; 10; 12; 13 (50mmL)	
20-Socket bit (32mmL)			
32432 03...08	Hex 3; 4; 5; 6; 8 mm		
32632 10...40	Star T10; T15; T20; T25; T30; T40		
32332 04...065	Slotted 4; 5.5; 6.5 mm		
32132 1...3	Phillips PH.1; PH.2; PH.3		
32232 1...3	Pozidriv PZ.1; PZ.2; PZ.3		
80222	1-Ratchet handle		
8042 050...100	2-Extension bar 2"; 4"		
8032115	1-Sliding T handle		
80521	1-Universal joint		
8143	1-Spinner		
764-3	3-Hex key 1.5; 2; 2.5 mm		

<b>2461-5</b>			
Part no.	Socket	10/18.0/19.0/1.3'	1800g
Content: 1/4" DR.			
525 04...14	13-6pt. Flank socket	4; 4.5; 5; 5.5; 6; 7; 8; 9; 10; 11; 12; 13; 14 mm	
52550 08...13	4-6pt. Flank deep socket	8; 10; 12; 13 (50mmL)	

**46pc 1/4" Socket combination set**



<b>2462</b>			
Part no.	Socket	10/12.5/13.5/0.8'	1250g
Content: 1/4" DR.			
525 04...14	13-6pt. Flank socket	4; 4.5; 5; 5.5; 6; 7; 8; 9; 10; 11; 12; 13; 14 mm	
22-Socket bit (32mmL)			
32432 03...08	Hex 3; 4; 5; 6; 7; 8 mm		
32632 08...40	Star T8; T10; T15; T20; T25; T30; T40		
32332 04...07	Slotted 4; 5.5; 7 mm		
32132 1...3	Phillips PH.1; PH.2; PH.3		
32232 1...3	Pozidriv PZ.1; PZ.2; PZ.3		
80222	1-Ratchet handle		
8042 050...100	2-Extension bar 2"; 4"		
8032115	1-Sliding T handle		
8111	1-Flexible extension		
80521	1-Universal joint		
8143	1-Spinner		
764-4	4-Hex key 1.27; 1.5; 2; 2.5 mm		

<b>2462-7</b>			
Part no.	Socket	10/12.5/13.5/0.8'	1250g
Content: 1/4" DR.			
527 04...14	13-Surface drive socket	4; 4.5; 5; 5.5; 6; 7; 8; 9; 10; 11; 12; 13; 14 mm	



<b>2462-9</b>			
Part no.	Socket	10/12.5/13.5/0.8'	1250g
Content: 1/4" DR.			
529 04...14	13-12pt. Flank socket	4; 4.5; 5; 5.5; 6; 7; 8; 9; 10; 11; 12; 13; 14 mm	





**50pc 1/4" Combination set**

<b>2502</b>			
Part no.	Socket	10/14.7/15.7/1'	1500g
525 04...14	Content: 1/4" DR. 13-6pt. Flank socket 4; 4.5; 5; 5.5; 6; 7; 8; 9; 10; 11; 12; 13; 14 mm		
52550 08...13	4-6pt. Flank deep socket 8; 10; 12; 13 mm		
32432 03...08	23-Socket bit (32mmL) Hex 3; 4; 5; 6; 7; 8 mm		
32132 1...3	Phillips PH.1; PH.2; PH.3		
32232 1...3	Pozidriv PZ.1; PZ.2; PZ.3		
32332 04...065	Slotted 4; 5.5; 6.5 mm		
32632 08...40	Star T8; T10; T15; T20; T25; T27;T30; T40		
80229	1-72 teeth ratchet handle		
8042 050...100	2-Extension bar 2"; 4"		
8032115	1-Sliding T handle		
80521	1-Universal joint		
8143	1-Spinner		
764-4	4-Hex key 1.27; 1.5; 2; 2.5		



**57pc 1/4" Combination set**

<b>2571</b>			
Part no.	Socket	15/21.0/22.0/1'	1400g
525 04...14	Content: 1/4" DR. 13-6pt. Flank socket 4; 4.5; 5; 5.5; 6; 7; 8; 9; 10; 11; 12; 13; 14 mm		
52550 06...10	4-6pt. Flank deep socket 6; 7; 8; 10 mm		
32132 1...3	24-Socket bit (32mmL) Phillips PH.1; PH.2; PH.3		
32232 1...3	Pozidriv PZ.1; PZ.2; PZ.3		
32332 04...065	Slotted 4; 5.5; 6.5 mm		
32432 03...10	Hex 3; 4; 5; 6; 7; 8; 10 mm		
32632 08...40	Star T8; T10; T15; T20; T25; T27; T30; T40		
526 04...10	6-Star socket E4; E5; E6; E7; E8; E10		
80229	1-72 teeth ratchet handle		
8032115	2-Sliding T handle		
8042 050...100	1-Extension bar 2"; 4"		
80521	1-Universal joint		
8143	1-Spinner		
764-4	4-Hex key 1.27; 1.5; 2; 2.5 mm		

**2502-7**

<b>2502-7</b>			
Part no.	Socket	10/14.7/15.7/1'	1500g
Changed Items	Content: 1/4" DR.		
527 04...14	13-Surface drive socket 4; 4.5; 5; 5.5; 6; 7; 8; 9; 10; 11; 12; 13; 14 mm		
52750 08...13	4-Surface drive deep socket 8; 10; 12; 13 mm		

**2502-9**

<b>2502-9</b>			
Part no.	Socket	10/14.7/15.7/1'	1500g
Changed Items	Content: 1/4" DR.		
529 04...14	13-12pt. Flank socket 4; 4.5; 5; 5.5; 6; 7; 8; 9; 10; 11; 12; 13; 14 mm		
52950 08...13	4-12pt. Flank deep socket 8; 10; 12; 13 mm		





**61pc 1/4" bit set**

**2611A**



Part no.	30/16.1/17.1/0.98'	520g
	Content: 1/4"	
12125 1...3	23-Phillips bit (25mmL) PH.1x7pc; PH.2x13pc; PH.3x3pc	
12225 1...3	23-Pozidriv bit (25mmL) PZ.1x7pc; PZ.2x13pc; PZ.3x3pc	
12325 04...065	3-Slotted bit (25mmL) 4; 5.5; 6.5 mm	
12425 03...06	4-Hex bit (25mmL) 3; 4; 5; 6 mm	
12625 10...40	7-Star bit (25mmL) T10; T15; T20; T25; T27; T30; T40	
81260Q	1-Magnetic quick-release holder	

**61pc 1/4" bit set**

**2611B**



Part no.	30/16.1/17.1/0.98'	520g
	Content: 1/4"	
12125 1...3	23-Phillips bit (25mmL) PH.1x7pc; PH.2x13pc; PH.3x3pc	
12225 1...3	23-Pozidriv bit (25mmL) PZ.1x7pc; PZ.2x13pc; PZ.3x3pc	
12325 04...065	3-Slotted bit (25mmL) 4; 5.5; 6.5 mm	
12425 03...06	4-Hex bit (25mmL) 3; 4; 5; 6 mm	
12625 10...40	7-Star bit (25mmL) T10; T15; T20; T25; T27; T30; T40	
81280Q	1-Magnetic quick-release holder with screw steady *81280Q with a second magnet to keep screws always straight and centered	



**65pc 1/4" Socket combination set**

<b>2641</b>			
Part no.	Socket	6/15.0/16.0/0.9'	2500g
	Content: 1/4" DR.		
525 032...14	14-6pt. Flank socket	3.2; 4; 4.5; 5; 5.5; 6; 7; 8; 9; 10; 11; 12; 13; 14 mm	
52550 05...13	9-6pt. Flank deep socket	5; 6; 7; 8; 9; 10; 11; 12; 13 mm	
	24-Socket bit (32mmL)		
32432 03...10	Hex 3; 4; 5; 6; 7; 8; 10 mm		
32132 1...3	Phillips PH.1; PH.2; PH.3		
32232 1...3	Pozidriv PZ.1; PZ.2; PZ.3		
32332 04...065	Slotted 4; 5.5; 6.5 mm		
32632 08...40	Star T8; T10; T15; T20; T25; T27; T30; T40		
80229	1-72 teeth ratchet handle		
8042 050...150	1-Extension bar 2"; 4"; 6"		
8032115	1-Sliding T handle		
80521	1-Universal joint		
8143	1-Spinner 6"		
81225	1-Magnetic socket pick-up		
5102XLB	10 pc Hex ball point long key set		
7650127XL...	1.27; 1.5; 2; 2.5; 3; 4; 5; 6; 8;		
10XL	10 mm		

**74pc 1/4" Socket combination set**

<b>2741</b>			
Part no.	Socket	6/14.2/15.2/0.9	1840g
	Content: 1/4" DR.		
	18-6pt. Flank socket		
525 04...13	4; 4.5; 5; 5.5; 6; 7; 8; 9; 10; 11; 12; 13 mm		
525 3.16...1.2	3/16"; 1/4"; 9/32"; 11/32"; 3/8"; 1/2"		
	18-6pt. Flank deep socket		
52550 04...13	4; 4.5; 5; 5.5; 6; 7; 8; 9; 10; 11; 12; 13 mm		
52550 3.16...1.2	3/16"; 1/4"; 9/32"; 11/32"; 3/8"; 1/2"		
	30-Socket bit (32mmL)		
32432 03...10	Hex 3, 4, 5, 6, 7, 8, 10 mm		
32432 1.8...3.8	Hex 1/8"; 3/16"; 7/32"; 1/4"; 3/8"		
32132 1...3	Phillips PH.1, PH.2, PH.3		
32232 1...3	Pozidriv PZ.1, PZ.2, PZ.3		
32332 03...065	Slotted 3; 4, 5.5, 6.5 mm		
32632 08...40	Star T8; T10; T15; T20; T25; T27; T30; T40		
802215	1-Ratchet handle		
8042 050...150	3-Extension bar 2"; 4"; 6"		
8032115	1-Sliding T handle		
80521	1-Universal joint		
8143	1-Spinner 6"		
81225	1-Magnetic socket pick-up		



**74pc 1/4" Socket combination set**

**2742**



Part no.	Socket	6/12.7/13.7/0.9'	1580g
	Content: 1/4" DR.		
525 04...13	12-6pt. Flank socket	4; 4.5; 5; 5.5; 6; 7; 8; 9; 10; 11; 12; 13 mm	
52550 04...13	12-6pt. Flank deep socket	4; 4.5; 5; 5.5; 6; 7; 8; 9; 10; 11; 12; 13 mm	
526 04...10	6-Star socket	E4; E5; E6; E7; E8; E10	
52650 04...10	6-Star deep socket	E4; E5; E6; E7; E8; E10	
	32-Socket bit (32mmL)		
32432 03...10	Hex 3; 4; 5; 6; 7; 8; 10 mm		
32132 0...2	Phillips PH.0; PH.1; PH.2		
32232 0...2	Pozidriv PZ.0; PZ.1; PZ.2		
32332 04...065	Slotted 4; 5.5; 6.5 mm		
32632 08...40	Star T8; T10; T15; T20; T25; T27; T30; T40		
32732 08...40	Star tamperproof T-8H; T-10H; T-15H; T-20H; T-25H; T-27H; T-30H; T-40H		
802220	1-T mini ratchet		
8042 050...150	3-Extension bar 2"; 4"; 6"		
80521	1-Universal joint		
81225	1-Magnetic socket pick-up		

**74pc Socket combination set**

**2742-18**



Part no.	Socket	6/12.7/13.7/0.9'	1580g
	Content: 1/4" DR.		
525 04...13	12-6pt. Flank socket	4; 4.5; 5; 5.5; 6; 7; 8; 9; 10; 11; 12; 13 mm	
52550 04...13	12-6pt. Flank deep socket	4; 4.5; 5; 5.5; 6; 7; 8; 9; 10; 11; 12; 13 mm	
526 04...10	6-Star socket	E4; E5; E6; E7; E8; E10	
52650 04...10	6-Star deep socket	E4; E5; E6; E7; E8; E10	
	32-Socket bit (32mmL)		
32432 03...10	Hex 3; 4; 5; 6; 7; 8; 10 mm		
32132 0...2	Phillips PH.0; PH.1; PH.2		
32232 0...2	Pozidriv PZ.0; PZ.1; PZ.2		
32332 04...065	Slotted 4; 5.5; 6.5 mm		
32632 08...40	Star T8; T10; T15; T20; T25; T27; T30; T40		
32732 08...40	Star tamperproof T-8H; T-10H; T-15H; T-20H; T-25H; T-27H; T-30H; T-40H		
802218	1-Flexible ratchet		
8042 050...150	3-Extension bar 2"; 4"; 6"		
80521	1-Universal joint		
81225	1-Magnetic socket pick-up		



**102pc 1/4" bit set**

**21021**



Part no.	10/15.5/16.5/1'	1550g
	Content:	
12125 0...3	40-1/4" Phillips bit (25mmL) PH.0; PH.1; PH.2; PH.3 each 10pcs	
12225 1...3	30-1/4" Pozidriv bit (25mmL) PZ.1; PZ.2; PZ.3 each 10pcs	
12325 04...065	30-1/4" Slotted bit (25mmL) 4; 5.5; 6.5 mm each 10pcs	
81260	1-Magnetic bit holder (60mmL)	
81260Q	1-Magnetic quick-release bit holder	

**102pc 1/4" bit set**

**21022**



Part no.	20/17.8/18.8/0.9'	1550g
	Content:	
12125 1...3	15-Phillips bits (25mmL) PH.1x5pc; PH.2x5pc; PH.3x5pc	
12225 1...3	15-Pozidriv bits (25mmL) PZ.1x5pc; PZ.2x5pc; PZ.3x5pc	
12325 04...065	15-Slotted bits (25mmL) 4x5pc; 5.5x5pc; 6.5x5pc	
12425 02...06	10-Hex bits (25mmL) 2x2pc; 3x2pc; 4x2pc; 5x2pc; 6x2pc	
12625 06...40	27-Star bits (25mmL) T6x3pc; T8x3pc; T10x3pc; T15x3pc; T20x3pc; T25x3pc; T27x3pc; T30x3pc; T40x3pc	
12725 06...40	18-Star tamperproof bits (25mmL) T-6Hx2pc; T-8Hx2pc; T-10Hx2pc; T-15Hx2pc; T-20Hx2pc; T-25Hx2pc; T-27Hx2pc; T-30Hx2pc; T-40Hx2pc	
81260Q	1-Magnetic quick-release holder	
81260	1-Magnetic bit holder (60mmL)	



**1/4" Phillips bit**

<b>121</b>		<i>l</i>		
Part no.	size	mm	g	pc/box
121250	PH.0	25	4	10
121251	PH.1	25	4	10
121252	PH.2	25	6	10
121253	PH.3	25	6	10
121300	PH.0	30	6	10
121301	PH.1	30	6	10
121302	PH.2	30	6	10
121303	PH.3	30	6	10

**1/4" Slotted bit**



<b>123</b>		<i>l</i>		
Part no.	size	mm	g	pc/box
1232503	0.5x3	25	4	10
1232504	0.8x4	25	4	10
1232505	0.8x5	25	4	10
12325055	1.0x5.5	25	4	10
12325065	1.2x6.5	25	4	10
1233004	0.8x4	30	6	10
1233005	0.8x5	30	6	10
12330055	1.0x5.5	30	6	10
1233006	1.0x6	30	6	10
12330065	1.2x6.5	30	6	10
1233007	1.2x7	30	6	10

**1/4" Pozidriv bit**

<b>122</b>		<i>l</i>		
Part no.	size	mm	g	pc/box
122250	PZ.0	25	4	10
122251	PZ.1	25	4	10
122252	PZ.2	25	6	10
122253	PZ.3	25	6	10
122300	PZ.0	30	6	10
122301	PZ.1	30	6	10
122302	PZ.2	30	6	10
122303	PZ.3	30	6	10





**1/4" Hex bit**

<b>124</b>		<i>l</i>		
Part no.	size	mm	g	pc/box
12425015	1.5	25	4	10
1242502	2	25	4	10
12425025	2.5	25	4	10
1242503	3	25	4	10
1242504	4	25	5	10
1242505	5	25	5	10
12425055	5.5	25	5	10
1242506	6	25	5	10
1242507	7	25	6	10
1242508	8	25	6	10
1242510	10	25	8	10
124251.16	1/16"	25	4	10
124253.32	3/32"	25	4	10
124251.8	1/8"	25	4	10
124255.32	5/32"	25	5	10

<b>124</b>		<i>l</i>		
Part no.	size	mm	g	pc/box
124253.16	3/16"	25	4	10
124257.32	7/32"	25	4	10
124251.4	1/4"	25	4	10
124259.32	9/32"	25	4	10
124255.16	5/16"	25	6	10
124253.8	3/8"	25	6	10
12430015	1.5	30	6	10
1243002	2	30	6	10
12430025	2.5	30	6	10
1243003	3	30	6	10
1243004	4	30	7	10
1243005	5	30	8	10
12430055	5.5	30	8	10
1243006	6	30	8	10
1243007	7	30	8	10
1243008	8	30	10	10
1243010	10	30	12	10
124301.16	1/16"	30	6	10
124303.32	3/32"	30	6	10
124301.8	1/8"	30	6	10
124305.32	5/32"	30	7	10
124303.16	3/16"	30	7	10
124307.32	7/32"	30	8	10
124301.4	1/4"	30	8	10
124309.32	9/32"	30	8	10
124305.16	5/16"	30	8	10
124303.8	3/8"	30	10	10





**1/4" Hex ball point bit**

<b>125</b>		<i>l</i>		
Part no.	size	mm	g	pc/box
12525025	2.5	25	4	10
1252503	3	25	4	10
1252504	4	25	4	10
1252505	5	25	6	10
12525055	5.5	25	6	10
1252506	6	25	6	10
125251.8	1/8"	25	4	10
125255.32	5/32"	25	4	10
125253.16	3/16"	25	4	10
125257.32	7/32"	25	6	10
125251.4	1/4"	25	6	10
12530025	2.5	30	6	10
1253003	3	30	6	10
1253004	4	30	6	10
1253005	5	30	8	10
12530055	5.5	30	8	10
1253006	6	30	8	10
125301.8	1/8"	30	6	10
125305.32	5/32"	30	6	10
125303.16	3/16"	30	6	10
125307.32	7/32"	30	8	10
125301.4	1/4"	30	8	10





**1/4" Star bit**

<b>126</b>		<i>l</i>		
Part no.	size	mm	g	pc/box
1262504	T4	25	4	10
1262505	T5	25	4	10
1262506	T6	25	4	10
1262507	T7	25	4	10
1262508	T8	25	4	10
1262509	T9	25	4	10
1262510	T10	25	4	10
1262515	T15	25	4	10
1262520	T20	25	4	10
1262525	T25	25	4	10
1262527	T27	25	6	10
1262530	T30	25	6	10
1262540	T40	25	6	10
1263004	T4	30	6	10
1263005	T5	30	6	10
1263006	T6	30	6	10
1263007	T7	30	6	10
1263008	T8	30	6	10
1263009	T9	30	6	10
1263010	T10	30	6	10
1263015	T15	30	6	10
1263020	T20	30	6	10
1263025	T25	30	6	10
1263027	T27	30	8	10
1263030	T30	30	8	10
1263040	T40	30	8	10
1266525	T25	65	16	10





**1/4" Star tamperproof bit**

<b>127</b>		<i>l</i>		
Part no.	size	mm	g	pc/box
1272506	T-6H	25	4	10
1272507	T-7H	25	4	10
1272508	T-8H	25	4	10
1272509	T-9H	25	4	10
1272510	T-10H	25	4	10
1272515	T-15H	25	4	10
1272520	T-20H	25	4	10
1272525	T-25H	25	4	10
1272527	T-27H	25	6	10
1272530	T-30H	25	6	10
1272535	T-35H	25	6	10
1272540	T-40H	25	6	10
1273006	T-6H	30	6	10
1273007	T-7H	30	6	10
1273008	T-8H	30	6	10
1273009	T-9H	30	6	10
1273010	T-10H	30	6	10
1273015	T-15H	30	6	10
1273020	T-20H	30	6	10
1273025	T-25H	30	6	10
1273027	T-27H	30	8	10
1273030	T-30H	30	8	10
1273040	T-40H	30	8	10



**1/4" Spline bit**

<b>128</b>		<i>l</i>		
Part no.	size	mm	g	pc/box
1282504	M4	25	4	10
1282505	M5	25	4	10
1282506	M6	25	6	10
1282508	M8	25	6	10
1282510	M10	25	8	10



**1/4" Five-sided star tamperproof bit**

<b>12F</b>		<i>l</i>		
Part no.	size	mm	g	pc/box
12F2508	TS8	25	4	10
12F2510	TS10	25	4	10
12F2515	TS15	25	4	10
12F2520	TS20	25	4	10
12F2525	TS25	25	4	10
12F2527	TS27	25	4	10
12F2530	TS30	25	4	10
12F2540	TS40	25	4	10
12F2545	TS45	25	6	10
12F2550	TS50	25	8	10

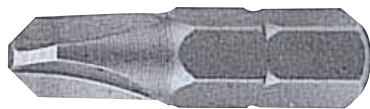

**1/4" Torq set bit**

<b>121S</b>		<i>l</i>		
Part no.	size	mm	g	pc/box
121S2506	6	25	6	10
121S2508	8	25	6	10
121S2510	10	25	6	10
121S251.4	1/4"	25	6	10



**1/4" Tri-wing bit**

<b>122S</b>		<i>l</i>		
Part no.	size	mm	g	pc/box
122S2501	1	25	6	10
122S2502	2	25	6	10
122S2503	3	25	6	10
122S2504	4	25	6	10

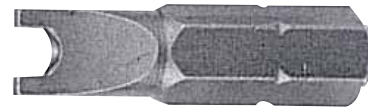

**1/4" Spanner bit**

<b>123S</b>		<i>l</i>		
Part no.	size	mm	g	pc/box
123S2504	4	25	6	10
123S2506	6	25	6	10
123S2508	8	25	6	10
123S2510	10	25	6	10



**1/4" Hex security bit**

<b>124S</b>		<i>l</i>		
Part no.	size	mm	g	pc/box
124S2502	2	25	6	10
124S25025	2.5	25	6	10
124S2503	3	25	6	10
124S2504	4	25	6	10
124S2505	5	25	6	10
124S2506	6	25	6	10
124S255.64	5/64"	25	6	10
124S253.32	3/32"	25	6	10
124S257.64	7/64"	25	6	10
124S251.8	1/8"	25	6	10
124S259.64	9/64"	25	6	10
124S255.32	5/32"	25	6	10



**1/4" Square bit**

<b>124R</b>		<i>l</i>		
Part no.	size	mm	g	pc/box
124R250	0	25	6	10
124R251	1	25	6	10
124R252	2	25	6	10
124R253	3	25	6	10





1/4" Phillips socket bit				
<b>321</b>		<i>l</i>		
Part no.	size	mm	g	pc/box
321320	PH.0	32	12	50
321321	PH.1	32	12	50
321322	PH.2	32	12	50
321323	PH.3	32	14	50



1/4" Hex socket bit				
<b>324</b>		<i>l</i>		
Part no.	size	mm	g	pc/box
3243203	3	32	13	50
3243204	4	32	14	50
3243205	5	32	14	50
3243206	6	32	14	50
3243207	7	32	16	50
3243208	8	32	17	50
3243210	10	32	21	50
324321.8	1/8"	32	14	50
324325.32	5/32"	32	14	50
324323.16	3/16"	32	14	50
324327.32	7/32"	32	14	50
324321.4	1/4"	32	16	50
324325.16	5/16"	32	16	50
324323.8	3/8"	32	20	50



1/4" Pozidriv socket bit				
<b>322</b>		<i>l</i>		
Part no.	size	mm	g	pc/box
322320	PZ.0	32	12	50
322321	PZ.1	32	12	50
322322	PZ.2	32	12	50
322323	PZ.3	32	14	50



1/4" Star socket bit				
<b>326</b>		<i>l</i>		
Part no.	size	mm	g	pc/box
3263208	T8	32	13	50
3263209	T9	32	13	50
3263210	T10	32	13	50
3263215	T15	32	13	50
3263220	T20	32	14	50
3263225	T25	32	14	50
3263227	T27	32	14	50
3263230	T30	32	14	50
3263240	T40	32	15	50
3269030	T30	90	26	10





1/4" Slotted socket bit				
<b>323</b>		<i>l</i>		
Part no.	size	mm	g	pc/box
3233204	0.8x4	32	12	50
32332055	1.0x5.5	32	12	50
32332065	1.2x6.5	32	12	50
3233207	1.2x7	32	12	50
323325.32	5/32"	32	12	50
323327.32	7/32"	32	12	50
323321.4	1/4"	32	12	50

3269030 -T30 90mmL

\*To remove and replace the screws on airbag of VW-Audi.





**1/4" Star tamperproof socket bit**

<b>327</b>		<i>l</i>		
Part no.	size	mm	g	pc/box
3273208	T-8H	32	13	50
3273210	T-10H	32	13	50
3273215	T-15H	32	13	50
3273220	T-20H	32	14	50
3273225	T-25H	32	14	50
3273227	T-27H	32	14	50
3273230	T-30H	32	14	50
3273240	T-40H	32	14	50





**1/4" Five-sided star tamperproof socket bit**

<b>32F</b>		<i>l</i>		
Part no.	size	mm	g	pc/box
32F3210	TS10	32	12	50
32F3215	TS15	32	12	50
32F3220	TS20	32	12	50
32F3225	TS25	32	12	50
32F3227	TS27	32	14	50
32F3230	TS30	32	14	50
32F3240	TS40	32	14	50





**1/4" DR. 6pt. Flank socket**

<b>525</b>		<i>l</i>		
Part no.	size	mm	g	pc/box
525032	3.2	25	10	50
52504	4	25	10	50
525045	4.5	25	11	50
52505	5	25	11	50
525055	5.5	25	11	50
52506	6	25	11	50
52507	7	25	12	50
52508	8	25	12	50
52509	9	25	14	50
52510	10	25	15	50
52511	11	25	18	50
52512	12	25	21	50
52513	13	25	22	50
52514	14	25	36	50
5255.32	5/32"	25	11	50
5253.16	3/16"	25	11	50
5257.32	7/32"	25	11	50
5251.4	1/4"	25	11	50
5259.32	9/32"	25	12	50
5255.16	5/16"	25	12	50
52511.32	11/32"	25	14	50
5253.8	3/8"	25	14	50
5257.16	7/16"	25	18	50
5251.2	1/2"	25	21	50
5259.16	9/16"	25	22	50





**1/4" DR. 6pt. Flank deep socket**

<b>52550</b>		<i>l</i>		
Part no.	size	mm	g	pc/box
5255004	4	50	14	50
52550045	4.5	50	16	50
5255005	5	50	17	50
52550055	5.5	50	18	50
5255006	6	50	20	50
5255007	7	50	22	50
5255008	8	50	27	50
5255009	9	50	29	40
5255010	10	50	34	30
5255011	11	50	40	30
5255012	12	50	41	20
5255013	13	50	52	20
5255014	14	50	54	20
525505.32	5/32"	50	14	50
525503.16	3/16"	50	17	50
525507.32	7/32"	50	18	50
525501.4	1/4"	50	20	50
525509.32	9/32"	50	22	50
525505.16	5/16"	50	27	50
5255011.32	11/32"	50	29	40
525503.8	3/8"	50	34	30
525507.16	7/16"	50	40	30
525501.2	1/2"	50	52	20





**1/4" DR. Star socket**

<b>526</b>		<i>l</i>		
Part no.	size	mm	g	pc/box
52604	E4	25	10	50
52605	E5	25	10	50
52606	E6	25	11	50
52607	E7	25	11	50
52608	E8	25	12	50
52610	E10	25	12	50
52611	E11	25	14	50
52612	E12	25	17	50
52614	E14	25	21	50
52616	E16	25	30	50





**1/4" DR. Star deep socket**



<b>52650</b>		<i>l</i>		
Part no.	size	mm	g	pc/box
5265004	E4	50	14	50
5265005	E5	50	19	50
5265006	E6	50	19	50
5265007	E7	50	21	50
5265008	E8	50	23	50
5265010	E10	50	28	30



**1/4" DR. Surface drive socket**



<b>527</b>		<i>l</i>		
Part no.	size	mm	g	pc/box
52704	4	25	10	50
527045	4.5	25	10	50
52705	5	25	10	50
527055	5.5	25	11	50
52706	6	25	11	50
52707	7	25	12	50
52708	8	25	12	50
52709	9	25	13	50
52710	10	25	15	50
52711	11	25	24	50
52712	12	25	28	50
52713	13	25	32	50
52714	14	25	36	50
5275.32	5/32"	25	10	50
5273.16	3/16"	25	11	50
5277.32	7/32"	25	11	50
5271.4	1/4"	25	12	50
5279.32	9/32"	25	12	50
5275.16	5/16"	25	12	50
52711.32	11/32"	25	13	50
5273.8	3/8"	25	15	50
5277.16	7/16"	25	24	50
5271.2	1/2"	25	32	50
5279.16	9/16"	25	38	50

**1/4" DR. Surface drive deep socket**



<b>52750</b>		<i>l</i>		
Part no.	size	mm	g	pc/box
5275006	6	50	20	50
5275007	7	50	20	50
5275008	8	50	24	50
5275009	9	50	30	40
5275010	10	50	36	30
5275011	11	50	46	30
5275012	12	50	50	20
5275013	13	50	52	15



**1/4" DR. 12pt. Flank socket**

<b>529</b>		<i>l</i>		
Part no.	size	mm	g	pc/box
52904	4	25	10	50
529045	4.5	25	11	50
52905	5	25	11	50
529055	5.5	25	11	50
52906	6	25	11	50
52907	7	25	12	50
52908	8	25	12	50
52909	9	25	13	50
52910	10	25	15	50
52911	11	25	19	50
52912	12	25	20	50
52913	13	25	22	50
52914	14	25	25	50
5295.32	5/32"	25	11	50
5293.16	3/16"	25	11	50
5297.32	7/32"	25	11	50
5291.4	1/4"	25	12	50
5299.32	9/32"	25	12	50
5295.16	5/16"	25	12	50
52911.32	11/32"	25	13	50
5293.8	3/8"	25	15	50
5297.16	7/16"	25	19	50
5291.2	1/2"	25	22	50
5299.16	9/16"	25	25	50







**1/4" DR. 12pt. Flank deep socket**

<b>52950</b>		<i>l</i>		
Part no.	size	mm	g	pc/box
5295005	5	50	18	50
52950055	5.5	50	18	50
5295006	6	50	21	50
5295007	7	50	22	50
5295008	8	50	22	50
5295009	9	50	28	40
5295010	10	50	33	30
5295011	11	50	44	30
5295012	12	50	44	20
5295013	13	50	45	20











**1/4" DR. Spline socket**

<b>52Q</b>						<i>l</i>			
Part no.	size	6point	12point	SAE	E-Torx	XZN	mm	g	pc/box
52Q032	3.2	•	•	1/8"	E4		25	10	50
52Q04	4	•	•	5/32"	E5	4	25	10	50
52Q045	4.5	•	•				25	10	50
52Q05	5	•	•	3/16"	E6	5	25	12	50
52Q055	5.5	•	•	7/32"	E7		25	12	50
52Q06	6	•	•		E8	6	25	12	50
52Q07	7	•	•	9/32"		7	25	12	50
52Q08	8	•	•	5/16"	E10	8	25	12	50
52Q09	9	•	•	11/32"	E11	9	25	18	50
52Q10	10	•	•	3/8"	E12	10	25	18	50
52Q11	11	•	•	7/16"	E14	11	25	24	50
52Q12	12	•	•	15/32"		12	25	28	50
52Q13	13	•	•	1/2"	E16		25	32	50
52Q14	14	•	•	9/16"	E18	14	25	36	50



**1/4" DR. Spline deep socket**

<b>52Q50</b>						<i>l</i>			
Part no.	size	6point	12point	SAE	E-Torx	XZN	mm	g	pc/box
52Q5004	4	•	•	5/32"	E5	4	50	14	50
52Q50045	4.5	•	•				50	16	50
52Q5005	5	•	•	3/16"	E6	5	50	16	50
52Q50055	5.5	•	•	7/32"	E7		50	20	50
52Q5006	6	•	•		E8	6	50	20	50
52Q5007	7	•	•	9/32"		7	50	20	50
52Q5008	8	•	•	5/16"	E10	8	50	24	50
52Q5009	9	•	•	11/32"	E11	9	50	30	50
52Q5010	10	•	•	3/8"	E12	10	50	36	50
52Q5011	11	•	•	7/16"	E14	11	50	46	50
52Q5012	12	•	•	15/32"		12	50	50	50
52Q5013	13	•	•	1/2"	E16		50	52	50
52Q5014	14	•	•	9/16"	E18	14	50	56	50



**1/4" DR. Swivel handle**

**8012**

Part no.	l mm	g	pc/box
8012140	140-5.5"	118	10

\* Spare part available



**1/4" DR. Ratchet handle-24 teeth-Thin**

**80224**

Part no.	l mm	g	pc/box
80224	125	142	1

\* Spare part available



**1/4" DR. Ratchet handle-24 teeth**

**80222**

Part no.	l mm	g	pc/box
80222	155	150	1

\* Spare part available



**1/4" DR. Ratchet handle-24 teeth-RD**

**80225**

Part no.	l mm	g	pc/box
80225	115	148	1

\* Spare part available



**1/4" DR. 72 teeth round ratchet handle**

**802222**

Part no.	l mm	g	pc/box
802222	150	114	1

\* Spare part available



**1/4" DR. Ratchet handle-32 teeth**

**80226**

Part no.	l mm	g	pc/box
80226	137	124	1

\* Spare part available



**1/4" DR. 72 teeth flexible round ratchet handle**

**802223**

Part no.	l mm	g	pc/box
802223	150	126	1

\* Spare part available



**1/4" DR. 72 teeth Ratchet handle**

**80229**

Part no.	l mm	g	pc/box
80229	145	132	1

\* Spare part available





**1/4" DR. Ratchet handle-24 teeth**

**802211**

Part no.	l mm	g	pc/box
802211	140	168	1

\* Spare part available



**1/4" DR. T mini ratchet handle - 48 teeth**

**802220**

Part no.	l mm	g	pc/box
802220	110	77	1

\* Spare part available



**1/4" DR. Ratchet handle-20 teeth**

**802215**

Part no.	l mm	g	pc/box
802215	130	120	1

\* Spare part available



**1/4" DR. Gearless ratchet**

**802221**

Part no.	l mm	g	pc/box
802221	128	128	1



**1/4" DR. Flexible ratchet handle-20 teeth**

**802218**

Part no.	l mm	g	pc/box
802218	125	146	1

\* Spare part available



**1/4" DR. Bit ratchet handle-20 teeth**

**802202**

Part no.	size	l mm	g	pc/box
802202	For 1/4" bit	130	118	1

\* Spare part available



**1/4" DR. Stubby ratchet handle-20 teeth**

**802219**

Part no.	l mm	g	pc/box
802219	95	104	1

\* Spare part available



**1/4" DR. Flexible bit ratchet handle-20 teeth**

**802202F**

Part no.	size	l mm	g	pc/box
802202F	For 1/4" bit	125	142	1

\* Spare part available





**1/4" DR. Sliding T handle**

<b>8032</b>	<i>l</i>		
Part no.	mm	g	pc/box
8032115	115	42	10



**Adaptor for 1/4" DR. Extension**

<b>806</b>		<i>l</i>		
Part no.	size	mm	g	pc/box
80622	1/4"(F)x1/4"(M)	26	15	50
80632	3/8"(F) x1/4"(M)	35	29	20



**1/4" DR. Extension**

<b>8042</b>	<i>l</i>		
Part no.	mm	g	pc/box
8042050	50-2"	23	20
8042100	100-4"	46	10
8042150	150-6"	66	10
8042250	250-10"	110	10



**1/4" DR. Adaptor**

<b>8092</b>		<i>l</i>		
Part no.	size	mm	g	pc/box
80923	1/4"(F) x3/8"(M)	26	18	25



**1/4" DR. Wobble extension**

<b>8042..W</b>	<i>l</i>		
Part no.	mm	g	pc/box
8042050W	50-2"	23	20
8042075W	75-3"	34	10
8042100W	100-4"	46	10
8042150W	150-6"	66	10
8042225W	225-9"	101	10
8042250W	250-10"	110	10



**1/4" Bit adaptor**

<b>8092</b>		<i>l</i>		
Part no.	size	mm	g	pc/box
8092225	1/4"Hex-1/4"Sq.	25	8	10
8092230	1/4"Hex-1/4"Sq.	30	10	10
8092250	1/4"Hex-1/4"Sq.	50	16	50



**1/4" DR. Universal joint**

<b>80521</b>	<i>l</i>		
Part no.	mm	g	pc/box
80521	37	23	20



**1/4" Adaptor extension**

<b>8092</b>		<i>l</i>		
Part no.	size	mm	g	pc/box
80922175	1/4"Hex-1/4"Sq.	175	73	20



**1/4" DR. Bit holder**

<b>8102</b>		<i>l</i>		
Part no.	size	mm	g	pc/box
81022	1/4"(F) x1/4"(F)	25	14	50



**1/4" Magnetic inhex extension**

<b>812</b>		<i>l</i>		
Part no.	size	mm	g	pc/box
81260	1/4"Hex-1/4"Inhex	60	23	50
812175	1/4"Hex-1/4"Inhex	175	55	20



**1/4" DR. Flexible inhex extension**

<b>8111</b>		<i>l</i>		
Part no.	size	mm	g	pc/box
8111	1/4"DR..	145	61	10



**1/4" Magnetic QR bit holder**

<b>812</b>		<i>l</i>		
Part no.	size	mm	g	pc/box
81260Q	1/4"Hex-1/4"Inhex	60	32	10



**1/4" DR. Flexible inhex extension**

<b>8112</b>		<i>l</i>		
Part no.	size	mm	g	pc/box
8112	1/4"Hex-1/4"Inhex	175	73	10



**1/4" Magnetic QR bit holder**

<b>812</b>		<i>l</i>		
Part no.	size	mm	g	pc/box
81280Q	1/4"Hex-1/4"Inhex	75	38	10

81280Q with a second magnet to keep screws always straight and centered.



**1/4" Flexible spinner**

<b>8113</b>		<i>l</i>		
Part no.	size	mm	g	pc/box
8113	1/4"DR.	275-11"	151	10





**1/4" DR. Magnetic socket pick-up**

<b>81225</b>		<i>l</i>		
Part no.	size	mm	g	pc/box
81225	1/4"DR.	25	16	50







**1/4" DR. Spinner**

<b>8142</b>		<i>l</i>		
Part no.	size	mm	g	pc/box
8142	1/4"DR.	150-6"	99	10





**1/4" DR. Quick-release bit spinner**

<b>8148</b>		<i>l</i>		
Part no.	size	mm	g	pc/box
8148	1/4"inhex	150-6"	105	10





**1/4" DR. Spinner**

<b>8143</b>		<i>l</i>		
Part no.	size	mm	g	pc/box
8143	1/4"DR.	150-6"	104	10





**1/4" DR. Plastic hanger**

<b>8162</b>		<i>l</i>		
Part no.	size	mm	g	pc/box
8162	1/4"DR.	68	3	100





**1/4" Magnetic Inhex Spinner**

<b>8144</b>		<i>l</i>		
Part no.	size	mm	g	pc/box
8144	1/4"inhex	215	117	10





**1/4" DR. Socket rail**

<b>8192...</b>		<i>l</i>		
Part no.	PCS	mm	g	pc/box
819210	10	160	25	10
819212	12	200	32	10
819230	30	560	122	10



**1/4" DR. Spinner**

<b>8145</b>		<i>l</i>		
Part no.	size	mm	g	pc/box
8145	1/4"DR.	150-6"	88	10

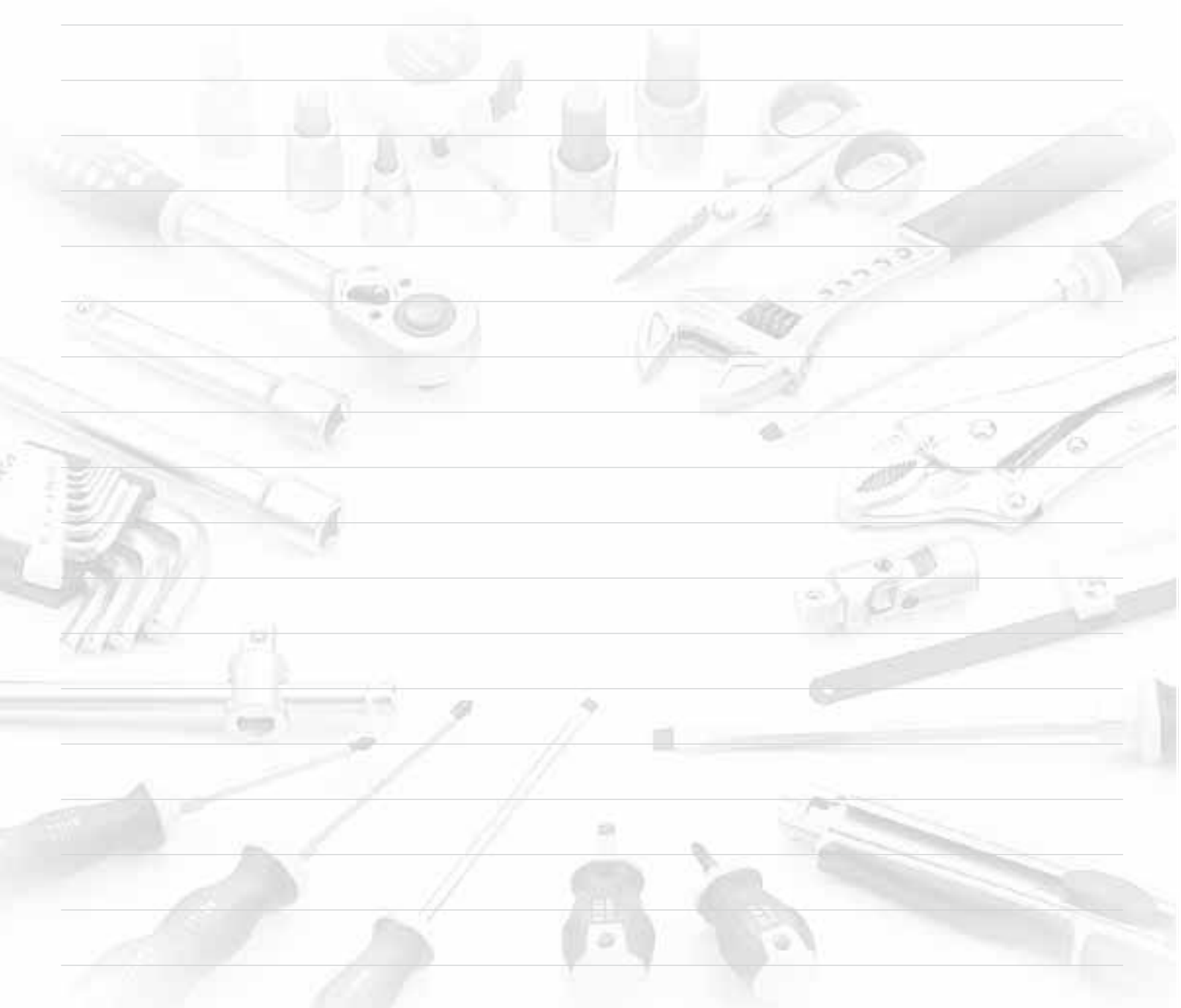



**5pc 3/8" Accessory set**

<b>3051</b>		
Part no.	20/17.5/18.5/1.3'	875g
802313	Content:3/8"DR.	
8073 16...20.6	1-Flex ratchet handle (round head)	
8043 044...075	2-Spark plug socket 16;20.6 mm	
	2-Extension bar 44; 75 mm	



**6pc 3/8" Hex socket bit set (MM)**

<b>3065</b>			
Part no.	Bit	40/14.5/15.5/1.1'	360g
334050 04...10	Content:3/8"DR.		
	6-Hex socket bit (50mmL)		
	4; 5; 6; 7; 8; 10 mm		

**6pc 3/8" Hex socket bit set (SAE)**

<b>3065S</b>			
Part no.	Bit	40/14.5/15.5/1.1'	360g
334050 1.8...7.16	Content:3/8"DR.		
	6-Hex socket bit (50mmL)		
	1/8"; 3/16"; 1/4"; 5/16"; 3/8"; 7/16"		



**5pc 3/8" Star socket set**

<b>3062</b>			
Part no.	Socket	80/15.0/16.0/1.7'	187g
536 08...16	Content:3/8"DR.		
	5-Star socket		
	E8; E10; E12; E14; E16		



**7pc 3/8" Star bit set**

<b>3071</b>			
Part no.	Bit	100/14.5/15.5/1.8'	145g
15635 25...55	Content:3/8"DR.		
	6-5/16" Star bit (35mmL)		
	T25; T30; T40; T45; T50; T55		
81035	1-Bit holder 3/8"DR.x5/16"		



**6pc 3/8" Star socket set**

<b>3064</b>			
Part no.	Socket	80/15.0/16.0/1.7'	187g
536 06...14	Content:3/8"DR.		
	6-Star socket		
	E6; E7; E8; E10; E12; E14		



**7pc 3/8" Hex socket bit set (MM)**

<b>3075</b>			
Part no.	Bit	48/21.0/22.0/1.4'	437g
334050 03...10	Content:3/8"DR. 7-Hex socket bit (50mmL) 3;4;5;6;7;8;10mm		

**7pc 3/8" Hex socket bit set (SAE)**

<b>3075S</b>			
Part no.	Bit	48/21.0/22.0/1.4'	437g
334050 1.8...3.8	Content:3/8"DR. 7-Hex socket bit (50mmL) 1/8"; 5/32"; 3/16"; 7/32"; 1/4"; 5/16"; 3/8"		
<b>3075SK</b>			
Part no.	Bit	48/21.0/22.0/1.4'	437g
334050 3.16...1.2	Content:3/8"DR. 7-Hex socket bit (50mmL) 3/16"; 7/32"; 1/4"; 5/16"; 3/8"; 7/16"; 1/2"		

**7pc 3/8" Star socket set**

<b>3072</b>			
Part no.	Socket	40/10.9/11.9/1'	272g
536 04...11	Content:3/8"DR. 7-Star socket E4; E5; E6; E7; E8; E10; E11		
<b>3073</b>			
Part no.	Socket	40/10.9/11.9/1'	272g
536 05...14	Content:3/8"DR. 7-Star socket E5; E6; E7; E8; E10; E12; E14		



**7pc 3/8" Universal deep socket set**

<b>3077S</b>			
Part no.	Socket	20/16.4/17.4/1.3'	437g
8053585 3.8...3.4	Content:3/8"DR. 7-3/8" Universal deep socket (85mmL) 3/8"; 7/16"; 1/2"; 9/16"; 5/8"; 11/16"; 3/4"		



**7pc Star socket set**

<b>3074</b>			
Part no.	Socket	80/15.0/16.0/1.7'	187g
526 06...08 536 10...16	Content:1/4"DR. & 3/8"DR. 6-Star socket 1/4"DR.: E6; E7; E8 3/8"DR.: E10; E12; E14; E16		



**7pc Ribe socket set**

<b>3078</b>			
Part no.	Bit	20/20.0/21.0/1.2'	1000g
	Content:3/8" & 1/2"DR.		
339090 06...10	4-3/8"DR. Ribe socket bit (90mmL) M6; M7; M8; M10		
349100 12...14	3-1/2"DR. Ribe socket bit (100mmL) M12; M13; M14		



**7pc Ratchet handle set**

<b>30711</b>		
Part no.	6/14.1/15.1/0.8'	2350g
	Content:3/8"DR.	
6473365	1-Torque wrench	
802318	1-Flexible ratchet handle	
802315	1-Ratchet handle	
802319	1-Stubby ratchet handle	
8073 16M...20.6M	3-Magnetic spark plug socket 16; 18; 20.6 mm	



**7pc 3/8" Universal socket set**

<b>30710S</b>			
Part no.	Socket	20/12.0/13.0/1.2'	500g
	Content:3/8"DR.		
80535 3.8...3.4	7-Universal socket (42mmL) 3/8"; 7/16"; 1/2"; 9/16"; 5/8"; 11/16"; 3/4"		



**7pc Ratchet handle set**

<b>30712</b>		
Part no.	6/14.7/15.7/0.9'	2440g
	Content:3/8"DR.	
6473365	1-Torque wrench	
80232	1-24 teeth ratchet handle	
802319	1-Stubby ratchet handle	
802323	1-72 teeth flexible ratchet handle	
807316...20.6	3-Spark plug socket 16; 18; 20.6mm	





**8pc 3/8" Hex socket bit set**

<b>3081</b>			
Part no.	Bit	60/18.0/19.0/1.7'	538g
334050 04...12	Content:3/8"DR. 8-Hex socket bit (50mmL) 4; 5; 6; 7; 8; 9; 10; 12 mm		



**9pc Star socket set**

<b>3092</b>			
Part no.	Socket	60/16.0/17.0/1.3'	265g
526 04...08 536 10...14	Content:1/4"DR. & 3/8"DR. 9-Star socket 1/4"DR.: E4; E5; E6; E7; E8 3/8"DR.: E10; E11; E12; E14		

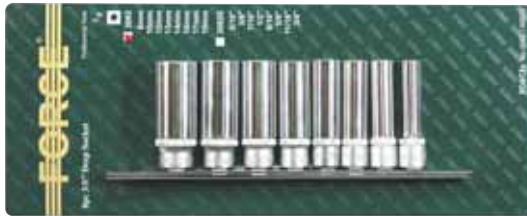

**8pc 3/8" Deep socket set (MM)**

<b>3082</b>			
Part no.	Socket	24/19.4/20.4/1.4'	806g
53563 08...19	Content:3/8"DR. 8-6pt. Flank deep socket (63mmL) 8; 10; 12; 13; 14; 16; 17; 19 mm		

**8pc 3/8" Deep socket set (SAE)**

<b>3082S</b>			
Part no.	Socket	24/19.4/20.4/1.4'	806g
53563 5.16...3.4	Content:3/8"DR. 8-6pt. Flank deep socket (63mmL) 5/16"; 3/8"; 7/16"; 1/2"; 9/16"; 5/8"; 11/16"; 3/4"		



**9pc 3/8" Socket set (MM)**

<b>3093</b>			
Part no.	Socket	40/22.0/23.0/1.7'	550g
535 09...19	Content:3/8"DR. 9-6pt. Flank socket 9; 10; 11; 12; 13; 14; 15; 17; 19 mm		

**9pc 3/8" Socket set (SAE)**

<b>3093S</b>			
Part no.	Socket	40/22.0/23.0/1.7'	550g
535 3.8...15.16	Content:3/8"DR. 9-6pt. Flank socket 3/8"; 7/16"; 1/2"; 9/16"; 5/8"; 11/16"; 3/4"; 13/16"; 15/16"		



**9pc 3/8" Star socket set**

<b>3091</b>			
Part no.	Socket	60/18.0/19.0/1.7'	300g
536 04...14	Content:3/8"DR. 9-Star socket E4; E5; E6; E7; E8; E10; E11; E12; E14		



**9pc 3/8" Star bit set**

<b>3094</b>			
Part no.	Bit	100/19.0/20.0/1.6'	190g
17630 20...60	Content:3/8"DR. 8-10mm Star bit (30mmL) T20; T25; T30; T40; T45; T50; T55; T60		
81037	1-Bit holder 3/8"DR.x10mm		



**10pc Star socket set**

<b>3101</b>			
Part no.	Socket	60/17.0/18.0/1.4'	283g
526 04...08	Content:1/4" & 3/8"DR. 10-Star socket 1/4"DR.: E4; E5; E6; E7; E8		
536 10...18	3/8"DR.: E10; E12; E14; E16; E18		



**9pc 1/4" & 3/8" Five-sided star tamperproof socket bit set**

<b>3095</b>			
Part no.	Bit	30/6.9/7.9/0.9'	230g
32F32 10...40	Content:1/4"DR. & 3/8"DR. 7-1/4"DR.: Five-sided star tamperproof socket bit TS10; TS15; TS20; TS25; TS27; TS30; TS40		
33F50 45...50	2-3/8"DR.: Five-sided star tamperproof socket bit TS45; TS50		





**10pc 3/8" Universal deep socket set**

<b>3103</b>			
Part no.	Socket	15/17.1/18.1/1'	1140g
8053585 10...19	Content:3/8"DR. 10-Universal deep socket (85mmL) 10; 11; 12; 13; 14; 15; 16; 17; 18; 19 mm		





**10pc 3/8" Universal socket set**

<b>3105</b>			
Part no.	Socket	15/9.8/10.8/1'	650g
80535 10...19	Content:3/8"DR. 10-Universal socket 10; 11; 12; 13; 14; 15; 16; 17; 18; 19 mm		





**10pc Spline deep socket set**

<b>3108Q</b>			
Part no.	Socket	24/24.0/22.0/0.9'	875g
53Q63 08...17	Content:3/8"DR. 10-Spline deep socket (63mmL) 8; 10; 11; 12; 13; 14; 15; 16; 17; 19 mm		





**11pc 3/8" 12pt. Socket set**

<b>3111</b>			
Part no.	Socket	36/17.0/18.0/1.6'	472g
538 08...18	Content:3/8"DR. 11-12pt. Socket 8; 9; 10; 11; 12; 13; 14; 15; 16; 17; 18 mm		





**11pc 3/8" Star deep socket set**

<b>3112</b>			
Part no.	Socket	24/2.5/21.5/1.9'	
53655 04...07	Content:3/8"DR. 11-Star deep socket E4; E5; E6; E7 (55mmL)		
53663 08...18	E8; E10; E11; E12; E14; E16; E18 (63mmL)		





**11pc Go-through ratchet socket set (SAE)**

<b>3114</b>			
Part no.	Socket	18/17.5/19.5/1.8'	940g
	Content:3/8"DR. 7- Go-through socket 3/8"; 7/16"; 1/2"; 9/16"; 5/8"; 11/16"; 3/4" 2- Push Adaptor 3/8"; 1/4" 1- Extension bar 75mmL 1- 72 teeth 3/8" go-through reverse combination ratchet		





**12pc 3/8" Deep socket set**

<b>3121</b>			
Part no.	Socket	6/10.6/11.6/0.9'	1760g
53563 08...22	Content:3/8"DR. 12-6pt. Flank deep socket (63mmL) 8; 10; 11; 12; 13; 14; 15; 16; 17; 18; 19; 22 mm		





**14pc Go-through ratchet socket set (MM)**

<b>3142</b>			
Part no.	Socket	18/19.0/21.0/1.8'	1050g
	Content:3/8"DR. 10-Go-through socket 10; 11; 12; 13; 14; 15; 16; 17; 18; 19 mm 2-Push Adaptor 3/8"; 1/4" 1-Extension bar 75mmL 1-72 teeth 3/8" go-through reverse combination ratchet		





**12pc Spline socket set**

<b>3122Q</b>			
Part no.	Socket	36/19.0/20.0/1.5'	528g
53Q 08...22	Content:3/8"DR. 12-Spline socket 8; 10; 11; 12; 13; 14; 15; 16; 17; 18; 19; 22 mm		



**15pc Surface drive deep socket set**

<b>3151</b>			
Part no.	Socket	20/22.4/23.4/1.2'	1120g
52750 08...13 53763 08...19	Content:1/4" & 3/8"DR. 15-Surface drive deep socket 1/4"DR.: 8; 9; 10; 11; 12; 13 mm 3/8"DR.: 8; 10; 11; 12; 13; 14; 15; 17; 19 mm		



**17pc Star set**
**19pc 6pt. Flank socket set (SAE)**

<b>3171</b>			
Part no.	Bit	25/13.5/14.5/0.64'	540g
526 06...08	Content: 1/4 DR. & 3/8 DR.		
536 10...16	7-Star socket		
15630 10...55	1/4"DR.: E6; E7; E8		
	3/8"DR.: E10; E12; E14; E16		
	9-5/16" Star bit (30mmL)		
	T10; T15; T20; T25; T30; T40; T45;		
	T50; T55		
81035	1-Bit holder 3/8"DR.(F)x5/16"		

<b>3193</b>			
Part no.	Socket	6/10.6/11.6/0.66'	1760g
535 1.4...7.8	Content: 3/8 DR.		
	11-6pt. Flank socket		
	1/4"; 5/16"; 3/8"; 7/16"; 1/2"; 9/16";		
	5/8"; 11/16"; 3/4"; 13/16"; 7/8"		
53563 5.16...3.4	8-6pt. Flank deep socket (63mmL)		
	5/16"; 3/8"; 7/16"; 1/2"; 9/16"; 5/8";		
	11/16"; 3/4"		

<b>3171T</b>			
Part no.	Bit	25/13.5/14.5/0.64'	540g
<b>Changed Items</b>	Content: 3/8 DR.		
15730 10...55	9-5/16" Star tamperproof bit (30mmL)		
	T-10H; T-15H; T-20H; T-25H;		
	T-30H; T-40H; T-45H; T-50H;		
	T-55H		

**21pc 3/8 Socket set (SAE)**

<b>3212</b>			
Part no.	Socket	6/12.2/13.2/0.9'	2040g
535 1.4...7.8	Content: 3/8 DR.		
	13-6pt. Flank socket		
	1/4"; 5/16"; 3/8"; 7/16"; 1/2"; 9/16";		
	19/32"; 5/8"; 11/16"; 3/4"; 25/32";		
	13/16"; 7/8"		
80232	1-Ratchet handle		
8033165	1-Sliding T handle		
8043 075...250	3-Extension bar 3"; 6"; 10"		
80531	1-Universal joint		
8073 16...20.6	2-Spark plug socket 16; 20.6 mm		





**21pc Go-through ratchet socket set (SAE & MM)**

<b>3213</b>			
Part no.	Socket	12/20.5/22.5/2.5'	1580g
Content:3/8"DR.			
17- Go-through socket 3/8"; 7/16"; 1/2"; 9/16"; 5/8"; 11/16"; 3/4" 10; 11; 12; 13; 14; 15; 16; 17; 18; 19 mm			
2- Push Adaptor 3/8"; 1/4"			
1- Extension bar 75mmL			
1- 72 teeth 3/8" go-through reverse combination ratchet			



**22pc Surface drive socket set**

<b>3222</b>			
Part no.	Socket	20/15.5/16.5/0.94'	775g
Content:1/4"DR. & 3/8"DR.			
22-Surface drive socket 1/4"DR.: 6; 7; 8; 9; 10; 11; 12; 13; mm 3/8"DR.: 6; 7; 8; 9; 10; 11; 12; 13; 14; 15; 16; 17; 18; 19 mm			
527 06...13			
537 06...19			





**22pc 3/8" Universal socket set**



<b>3224</b>			
Part no.	Socket	6/17.2/18.2/0.9'	2860g
Content:3/8"DR.			
80535 10...19	10-Universal socket (42mmL) 10; 11; 12; 13; 14; 15; 16; 17; 18; 19 mm		
8053585 10...19	10-Universal deep socket (85mmL) 10; 11; 12; 13; 14; 15; 16; 17; 18; 19 mm		
807316UM...20.6UM	2-Universal magnetic spark plug 16; 20.6 mm		



**23pc 3/8" Socket set**



<b>3232</b>			
Part no.	Socket	10/18.8/19.8/1'	1880g
Content:3/8"DR.			
535 06...22	17-6pt. Flank socket 6; 7; 8; 9; 10; 11; 12; 13; 14; 15; 16; 17; 18; 19; 20; 21; 22 mm		
80239	1-72 teeth ratchet handle		
8043 075...225	3-Extension bar 3"; 6"; 9"		
80531	1-Universal joint		
80643	1-Adaptor for extension 1/2"(F)x3/8"(M)		



<b>3232-7</b>			
Part no.	Socket	10/18.8/19.8/1'	1880g
<b>Changed Items</b> 537 06...22	Content:3/8"DR. 17-Surface drive socket 6; 7; 8; 9; 10; 11; 12; 13; 14; 15; 16; 17; 18; 19; 20; 21; 22 mm		



<b>3232-9</b>			
Part no.	Socket	10/18.8/19.8/1'	1880g
<b>Changed Items</b> 539 06...22	Content:3/8"DR. 17-12pt. Flank socket 6; 7; 8; 9; 10; 11; 12; 13; 14; 15; 16; 17; 18; 19; 20; 21; 22 mm		





**24pc 3/8" Socket set**



<b>3251</b>			
Part no.	Socket	6/15.0/16.0/0.9'	2500g
537 06...22	Content:3/8"DR. 17-Surface drive socket 6; 7; 8; 9; 10; 11; 12; 13; 14; 15; 16; 17; 18; 19; 20; 21; 22 mm		
80232	1-Ratchet handle		
8043 075...150	2-Extension bar 3"; 6"		
80531	1-Universal joint		
8033165	1-Sliding T handle		
8073 16...20.6	2-Spark plug socket 16; 20.6 mm		

<b>3251-5</b>			
Part no.	Socket	6/15.0/16.0/0.9'	2500g
<b>Changed Items</b> 535 06...22	Content:3/8"DR. 17-6pt. Flank socket 6; 7; 8; 9; 10; 11; 12; 13; 14; 15; 16; 17; 18; 19; 20; 21; 22 mm		



<b>3251-9</b>			
Part no.	Socket	6/15.0/16.0/0.9'	2500g
<b>Changed Items</b> 539 06...22	Content:3/8"DR. 17-12pt. Flank socket 6; 7; 8; 9; 10; 11; 12; 13; 14; 15; 16; 17; 18; 19; 20; 21; 22 mm		



<b>3251-72</b>			
Part no.	Socket	6/16.4/17.4/0.9'	2500g
<b>Changed Items</b> 80239	Content:3/8"DR. 1-72 teeth ratchet handle		

<b>3251-72-5</b>			
Part no.	Socket	6/16.4/17.4/0.9'	2100g
<b>Changed Items</b> 535 06...22	Content:3/8"DR. 17-6pt. Flank socket 6; 7; 8; 9; 10; 11; 12; 13; 14; 15; 16; 17; 18; 19; 20; 21; 22 mm		
80239	1-72 teeth ratchet handle		



<b>3251-5-18</b>			
Part no.	Socket	6/15.0/16.0/0.9'	2500g
<b>Changed Items</b> 535 06...22	Content:3/8"DR. 7- 6pt. Flank socket 6; 7; 8; 9; 10; 11; 12; 13; 14; 15; 16; 17; 18; 19; 20; 21; 22 mm		
802318	1- Flexible ratchet handle		



**24pc 3/8" Spline socket set**

<b>3251Q</b>			
Part no.	Socket	6/15.0/16.0/0.9'	2500g
53Q 06...22	Content:3/8"DR. 17- Spline socket 6; 7; 8; 9; 10; 11; 12; 13; 14; 15; 16; 17; 18; 19; 20; 21; 22 mm		
80232	1- Ratchet handle		
8043 075...150	2- Extension bar 3"; 6"		
80531	1- Universal joint		
8033165	1- Sliding T bar		
8073 16...20.6	2- Spark plug socket 16mm; 20.6mm		



**26pc 3/8" Socket set**

<b>3261</b>			
Part no.	Socket	4/10.0/11.0/0.85'	2500g
535 06...24	Content:3/8"DR. 18- 6pt. Flank socket 6; 7; 8; 9; 10; 11; 12; 13; 14; 15; 16; 17; 18; 19; 20; 21; 22; 24 mm		
80232	1- Ratchet handle		
8043 044...150	3- Extension bar 1-3/4"; 3"; 6"		
8073 16...20.6	2- Spark plug socket 16; 20.6 mm		
80531	1- Universal joint		
80643	1- Adaptor for extension 1/2"(F)x3/8" (M)		

<b>3261-7</b>			
Part no.	Socket	4/10.0/11.0/0.85'	2500g
<b>Changed Items</b> 537 06...24	Content:3/8"DR. 18-Surface drive socket 6; 7; 8; 9; 10; 11; 12; 13; 14; 15; 16; 17; 18; 19; 20; 21; 22; 24 mm		
<b>3261-9</b>			
Part no.	Socket	4/10.0/11.0/0.85'	2500g
<b>Changed Items</b> 539 06...24	Content:3/8"DR. 18-12pt. Flank socket 6; 7; 8; 9; 10; 11; 12; 13; 14; 15; 16; 17; 18; 19; 20; 21; 22; 24 mm		



**32pc Socket set (MM & SAE)**

<b>3322</b>			
Part no.	Socket	6/15.0/16.0/0.73'	2500g
535 06...22	Content:3/8"DR. 15- 6pt. Flank socket (MM) 6; 7; 8; 9; 10; 11; 12; 13; 14; 15; 16; 17; 18; 19; 20; 21; 22 mm		
535 1.4...13.16	11- 6pt. Flank socket (SAE) 1/4"; 3/8"; 1/2"; 9/16"; 5/8"; 11/16"; 13/16"		
8043 075...225	3- Extension bar 3"; 6"; 9"		
80643	1- Adaptor for extension 1/2"(F)x3/8" (M)		
80531	1- Universal joint		
802322	1- 72 teeth ratchet handle		
8073 16...20.6	2- Spark plug socket 16; 20.6 mm		



<b>3322-15</b>			
Part no.	Socket	6/15.0/16.0/0.73'	2500g
<b>Changed Items</b>	Content:3/8"DR.		
802315	1-30 teeth ratchet handle		



<b>3322-23</b>			
Part no.	Socket	6/15.0/16.0/0.73'	2500g
<b>Changed Items</b>	Content:3/8"DR.		
802323	1-72 teeth flexible round ratchet handle		



<b>3322-24</b>			
Part no.	Socket	6/15.0/16.0/0.73'	2500g
<b>Changed Items</b>	Content:3/8"DR.		
80232	1-24 teeth ratchet handle		



**35pc 3/8" Socket set**

<b>3351</b>			
Part no.	Socket	6/19.0/20.0/0.7'	3160g
Content:3/8"DR.			
539 06...21	15-12pt. Flank socket (MM) 6; 7; 8; 9; 10; 11; 12; 13; 14; 15; 16; 17; 18; 19; 21 mm		
539 1.4...7.8	11-12pt. Flank socket (SAE) 1/4"; 5/16"; 3/8"; 7/16"; 1/2"; 9/16"; 5/8"; 11/16"; 3/4"; 13/16"; 7/8"		
80232	1-Ratchet handle		
8043 075...225	3-Extension bar 3"; 6"; 9"		
80633	1-Adaptor for extension 3/8"(F)x3/8"(M)		
	2-Adaptor		
80932	3/8"DR.(F)x1/4"DR.(M)		
80934	3/8"DR.(F)x1/2"DR.(M)		
807316	1-Spark plug socket (16mm)		
80531	1-Universal joint		

<b>3351-5</b>			
Part no.	Socket	6/19.0/20.0/0.7'	3160g
<b>Changed Items</b>	Content:3/8"DR.		
535 06...21	15-6pt. Flank socket (MM) 6; 7; 8; 9; 10; 11; 12; 13; 14; 15; 16; 17; 18; 19; 21 mm		
535 1.4...7.8	11-6pt. Flank socket (SAE) 1/4"; 5/16"; 3/8"; 7/16"; 1/2"; 9/16"; 5/8"; 11/16"; 3/4"; 13/16"; 7/8"		





**36pc 3/8" Combination socket set**

<b>3361</b>			
Part no.	Socket	6/20.5/21.5/0.9'	3410g
	Content:3/8"DR.		
535 06...22	17-6pt. Flank socket 6; 7; 8; 9; 10; 11; 12; 13; 14; 15; 16; 17; 18; 19; 20; 21; 22 mm		
80239	1-72 teeth ratchet handle		
8043 075...225	3-Extension bar 3"; 6"; 9"		
8073 16...20.6	2-Spark plug socket 16; 20.6 mm		
80531	1-Universal joint		
80643	3-Adaptor for extension 1/2"(F)x3/8"(M)		
755 07...17	11-Combination wrench 7; 8; 9; 10; 11; 12; 13; 14; 15; 16; 17 mm		
<b>3361-7</b>			
Part no.	Socket	6/20.5/21.5/0.9'	3410g
<b>Changed Items</b>	Content:3/8"DR.		
537 06...22	17-Surface drive socket 6; 7; 8; 9; 10; 11; 12; 13; 14; 15; 16; 17; 18; 19; 20; 21; 22 mm		
<b>3361-9</b>			
Part no.	Socket	6/20.5/21.5/0.9'	3410g
<b>Changed Items</b>	Content:3/8"DR.		
539 06...22	17-12pt. Flank socket 6; 7; 8; 9; 10; 11; 12; 13; 14; 15; 16; 17; 18; 19; 20; 21; 22 mm		



**39pc 1/4" & 3/8" socket set**

<b>3391</b>			
Part no.	Socket	6/15.5/16.5/0.7'	2580g
	Content:1/4" & 3/8"DR.		
529 04...12	18-1/4"DR. 12pt. Flank Socket 4; 5; 6; 7; 8; 9; 10; 11; 12 mm		
529 3.16...1.2	3/16"; 7/32"; 1/4"; 9/32"; 5/16"; 11/32"; 3/8"; 7/16"; 1/2"		
539 09...19	16-3/8"DR. 12pt. Flank Socket 9; 10; 11; 12; 13; 14; 16; 17; 19 mm		
539 3.8...3.4	3/8"; 7/16"; 1/2"; 9/16"; 5/8"; 11/16"; 3/4"		
80232	1-Ratchet handle		
807316	1-Spark plug socket 5/8" (16mm)		
8043075	1-Extension bar 3"		
8145	1-Spinner handle		
80932	1-Adaptor 3/8"DR.(F)x1/4"DR.(M)		
<b>3391-5</b>			
Part no.	Socket	6/15.5/16.5/0.7'	2580g
<b>Changed Items</b>	Content:1/4" & 3/8"DR.		
525 04...12	18-1/4"DR. 6pt. Flank socket 4; 5; 6; 7; 8; 9; 10; 11; 12 mm		
525 3.16...1.2	3/16"; 7/32"; 1/4"; 9/32"; 5/16"; 11/32"; 3/8"; 7/16"; 1/2"		
535 09...19	16-3/8"DR. 6pt. Flank socket 9; 10; 11; 12; 13; 14; 16; 17; 19 mm		
535 3.8...3.4	3/8"; 7/16"; 1/2"; 9/16"; 5/8"; 11/16"; 3/4"		





**44pc 3/8" socket set**

Part no.	Socket	4/14.8/15.8/0.9'	3700g
<b>3441</b>			
Content:3/8"DR.			
535 06...22	17-6pt. Flank socket	6; 7; 8; 9; 10; 11; 12; 13; 14; 15; 16; 17; 18; 19; 20; 21; 22 mm	
53563 10...17	4-6pt. Flank deep socket	10; 13; 15; 17 mm	
334050 04...10	10-Socket bit (50mmL)	Hex 4; 5; 6; 8; 10 mm	
33650 20...40		Star T20; T25; T27; T30; T40	
80239	1-72 teeth ratchet handle		
8043 075...225	1-Extension bar	3"; 6"; 9"	
80531	1-Universal joint		
80643	1-Adaptor for extension	1/2"(F)x3/8"(M)	
8073 16...20.6	3-Spark plug socket	16; 18; 20.6 mm	
764-4	4-Hex key	1.27; 1.5; 2; 2.5 mm	



**45pc 3/8" socket set**

Part no.	Socket	4/20.2/21.2/0.9'	5550g
<b>3451</b>			
Content:3/8"DR.			
535 08...22	15-6pt. Flank socket (MM)	8; 9; 10; 11; 12; 13; 14; 15; 16; 17; 18; 19; 20; 21; 22 mm	

Part no.	Socket	4/20.2/21.2/0.9'	5550g
<b>3451</b>			
53563 08...22	11-6pt. Flank deep socket (MM)	8; 9; 10; 11; 12; 13; 14; 16; 17; 19; 22 mm	
535 3.8...13.16	5-6pt. Flank socket (SAE)	3/8"; 1/2"; 9/16"; 11/16"; 13/16"	
53563 3.8...13/16	5-6pt. Flank deep socket (SAE)	3/8"; 1/2"; 9/16"; 11/16"; 13/16"	
8073 16...20.6	3-Spark plug socket	10; 12; 14 mm (16; 18; 20.6 mm)	
802311	1-Ratchet handle		
8013200B	1-Bent flex handle		
8043 075...150	2-Extension bar	3"; 6"	
80643	1-Adaptor for extension	1/2"(F)x3/8"(M)	
80531	1-Universal joint		











**52pc Star set**

Part no.	Bit	6/18.0/19.0/0.9'	3000g
<b>3521</b>			
Content:3/8"DR.			
15630 20...55	13-15/16" Star bit	T20; T25; T30; T40; T45; T50; T55 (30mmL)	
15670 20...50		T20; T25; T30; T40; T45; T50 (70mmL)	
526 04...08	5-1/4"DR. Star socket	E4; E5; E6; E7; E8	
536 10...20	7-3/8"DR. Star socket	E10; E11; E12; E14; E16; E18; E20	
766 09...70	13-Star L key	T9; T10; T15; T20; T25; T27; T30; T40; T45; T50; T55; T60; T70	
12725 08...40	9-1/4" Star tamperproof bit	T-8H; T-10H; T-15H; T-20H; T-25H; T-27H; T-30H; T-35H; T-40H (25mmL)	
34614055	1-Star socket bit	T55 (140mmL)	
34605560	1-Star socket bit	T60 (55mmL)	
34610070	1-Star socket bit	T70 (100mmL)	
810 22...35	2-Bit holder	1/4"DR.x1/4"; 3/8"DR.x5/16"	









**55pc 3/8" Combination set**



<b>3551</b>			
Part no.	Socket	3/13.0/14.0/1'	4330g
	Content:3/8"DR.		
537 06...24	18-Surface drive socket 6; 7; 8; 9; 10; 11; 12; 13; 14; 15; 16; 17; 18; 19; 20; 21; 22; 24 mm		
80232	1-Ratchet handle		
8043 044...150	3-Extension 1-3/4"; 3"; 6"		
8073 16...20.6	2-Spark plug socket 16; 20.6 mm		
80531	1-Universal joint		
80643	1-Adaptor for extension 1/2"(F)x3/8"(M)		
755 08...22	9-Combination wrench 8; 10; 11; 12; 13; 14; 17; 19; 22 mm		
5102A	10 pc Hex key set		
764 0127...10	1.27; 1.5; 2; 2.5; 3; 4; 5; 6; 8; 10 mm		
5102XLBA	10 pc Hex ball point extra long key set		
765 0127...10 XL	1.27; 1.5; 2; 2.5; 3; 4; 5; 6; 8; 10 mm		
<b>3551-5</b>			
Part no.	Socket	3/13.0/14.0/1'	4330g
<b>Changed Items</b>	Content:3/8"DR.		
535 06...24	18-6pt. Flank socket 6; 7; 8; 9; 10; 11; 12; 13; 14; 15; 16; 17; 18; 19; 20; 21; 22; 24 mm		
<b>3551-9</b>			
Part no.	Socket	3/13.0/14.0/1'	4330g
<b>Changed Items</b>	Content:3/8"DR.		
539 06...24	18- 12pt. Flank socket 6; 7; 8; 9; 10; 11; 12; 13; 14; 15; 16; 17; 18; 19; 20; 21; 22; 24 mm		









**56pc 3/8" Combination set**

<b>3571</b>			
Part no.	Socket	3/17.0/18.0/1'	5667g
	Content:3/8"DR.		
539 06...24	14- 12pt. Flank socket 6; 7; 8; 9; 10; 11; 12; 13; 14; 15; 17; 19; 22; 24 mm		
	9-6pt. Flank deep socket		
53546 08...14	8; 10; 12; 13; 14 mm (46mmL)		
53563 17...24	17; 19; 22; 24 mm (63mmL)		
334080 04...12	7-Hex socket bit 4; 5; 6; 7; 8; 10; 12 mm (80mmL)		
	14-Socket bit (50mmL)		
33650 10...50	Star T10; T20; T25; T27; T30; T40; T45; T50		
33350 04...08	Slotted 0.8x4; 1.0x5.5; 1.2x8 mm		
33150 1...3	Phillips PH.1; PH.2; PH.3		
8073 16...20.6	3-Spark plug socket 16; 18; 20.6 mm		
80232	1-Ratchet handle		
8043 075...225	2-Extension bar 3"; 9"		
80531	1-Universal joint		
764-4	4-Hey key 1.27; 1.5; 2; 2.5;		
80633	1-Adaptor for extension 3/8"(F)x3/8"(M)		
<b>3571-5</b>			
Part no.	Socket	3/17.0/18.0/1'	5667g
<b>Changed Items</b>	Content:3/8"DR.		
535 06...24	14-6pt. Flank socket 6; 7; 8; 9; 10; 11; 12; 13; 14; 15; 17; 19; 22; 24 mm		

**56pc 3/8 Combination set**



<b>3571-72</b>			
Part no.	Socket	3/17.0/18.0/1'	5667g
	Content:3/8 DR.		
539 06...24	14- 12pt. Flank socket 6; 7; 8; 9; 10; 11; 12; 13; 14; 15; 17; 19; 22; 24 mm		
53546 08...14	9-6pt. Flank deep socket 8; 10; 12; 13; 14 mm (46mmL)		
53563 17...24	17; 19; 22; 24 mm (63mmL)		
334080 04...12	7-Hex socket bit (80mmL) 4; 5; 6; 7; 8; 10; 12 mm		
33650 10...50	14-Socket bit (50mmL) Star T10; T20; T25; T27; T30; T40; T45; T50		
33350 04...08	Slotted 0.8x4; 1.0x5.5; 1.2x8 mm		
33150 1...3	Phillips PH.1; PH.2; PH.3		
8073 16...20.6	3-Spark plug socket 16; 18; 20.6 mm		
80239	1-72 teeth ratchet handle		
8043 075...225	2-Extension bar 3"; 9"		
80531	1-Universal joint		
764-4	4-Hey key 1.27; 1.5; 2; 2.5;		
80633	1-Adaptor for extension 3/8"(F)x3/8"(M)		

**61pc 3/8 Combination set**

<b>3611</b>			
Part no.	Socket	4/18.0/19.0/1'	4500g
	Content:3/8 DR.		
537 06...24	18-Surface drive socket 6; 7; 8; 9; 10; 11; 12; 13; 14; 15; 16; 17; 18; 19; 20; 21; 22; 24 mm		
53563 08...19	9-6pt. Flank deep socket (63mmL) 8; 10; 11; 12; 13; 14; 15; 17; 19 mm		
334050 03...10	26-Socket bit (50mmL) Hex 3; 4; 5; 6; 7; 8; 10 mm		
33650 10...55	Star T10; T15; T20; T25; T27; T30; T40; T45; T50; T55		
33350 055...08	Slotted 5.5; 6.5; 8		
33150 1...3	Phillips PH.1; PH.2; PH.3		
33250 1...3	Pozidriv PZ.1; PZ.2; PZ.3		
80232	1-Ratchet handle		
8073 16...20.6	2-Spark plug socket 16; 20.6 mm		
8043 075...250	3-Extension bar 3"; 6"; 10"		
80531	1-Universal joint		
80643	1-Adaptor for extension 1/2"DR.x3/8"(M)		
			
<b>3611-5</b>	Socket	4/18.0/19.0/1'	4500g
	Content:3/8 DR.		
535 06...24	18-6pt. Flank socket 6; 7; 8; 9; 10; 11; 12; 13; 14; 15; 16; 17; 18; 19; 20; 21; 22; 24 mm		





**5/16" Phillips bit**

<b>151</b>		<i>l</i>		
Part no.	size	mm	g	pc/box
151301	PH.1	30	10	10
151302	PH.2	30	10	10
151303	PH.3	30	10	10
151304	PH.4	30	11	10
151321	PH.1	32	10	10
151322	PH.2	32	10	10
151323	PH.3	32	12	10
151384	PH.4	38	14	10





**5/16" Slotted bit**

<b>153</b>		<i>l</i>		
Part no.	size	mm	g	pc/box
15330055	0.8x5.5	30	9	10
1533007	1.2x7	30	10	10
1533008	1.2x8	30	12	10
1533010	1.6x10	30	14	10
1533012	2.0x12	30	14	10





**5/16" Pozidriv bit**

<b>152</b>		<i>l</i>		
Part no.	size	mm	g	pc/box
152301	PZ.1	30	10	10
152302	PZ.2	30	10	10
152303	PZ.3	30	10	10
152304	PZ.4	30	10	10
152321	PZ.1	32	10	10
152322	PZ.2	32	10	10
152323	PZ.3	32	12	10
152384	PZ.4	38	14	10







**5/16" Hex bit**





<b>154</b>		<i>l</i>		
Part no.	size	mm	g	pc/box
1543003	3	30	8	10
1543004	4	30	9	10
1543005	5	30	10	10
1543006	6	30	11	10
1543007	7	30	12	10
1543008	8	30	12	10
1543010	10	30	16	10
1543012	12	30	21	10
1543014	14	30	25	10
154301.8	1/8"	30	12	10
154305.32	5/32"	30	12	10
154303.16	3/16"	30	12	10
154301.4	1/4"	30	12	10
154309.32	9/32"	30	13	10
154305.16	5/16"	30	13	10
154303.8	3/8"	30	16	10
154307.16	7/16"	30	18	10
154301.2	1/2"	30	22	10
154309.16	9/16"	30	26	10



**5/16" Star bit**

<b>156</b>				
Part no.	size	mm	g	pc/box
1563010	T10	30	9	10
1563015	T15	30	9	10
1563020	T20	30	9	10
1563025	T25	30	9	10
1563027	T27	30	9	10
1563030	T30	30	10	10
1563040	T40	30	10	10
1563045	T45	30	11	10
1563050	T50	30	12	10
1563055	T55	30	14	10
1563060	T60	30	24	10
1563520	T20	35	12	10
1563525	T25	35	12	10
1563527	T27	35	12	10
1563530	T30	35	12	10
1563540	T40	35	12	10
1563545	T45	35	12	10
1563550	T50	35	14	10
1563555	T55	35	16	10
1567010	T10	70	30	10
1567015	T15	70	30	10
1567020	T20	70	30	10
1567025	T25	70	30	10
1567027	T27	70	30	10
1567030	T30	70	30	10
1567040	T40	70	30	10
1567045	T45	70	30	10
1567050	T50	70	30	10
1567055	T55	70	40	10
1567060	T60	70	56	10



**5/16" Star tamperproof bit**

<b>157</b>				
Part no.	size	mm	g	pc/box
1573010	T-10H	30	10	10
1573015	T-15H	30	10	10
1573020	T-20H	30	10	10
1573025	T-25H	30	10	10
1573027	T-27H	30	10	10
1573030	T-30H	30	10	10
1573040	T-40H	30	10	10
1573045	T-45H	30	10	10
1573050	T-50H	30	12	10
1573055	T-55H	30	14	10
1573060	T-60H	30	24	10
1577010	T-10H	70	30	10
1577015	T-15H	70	30	10
1577020	T-20H	70	30	10
1577025	T-25H	70	30	10
1577027	T-27H	70	30	10
1577030	T-30H	70	30	10
1577040	T-40H	70	30	10
1577045	T-45H	70	30	10
1577050	T-50H	70	30	10
1577055	T-55H	70	40	10
1577060	T-60H	70	56	10







**3/8" Phillips socket bit**

<b>331</b>		<i>l</i>		
Part no.	size	mm	g	pc/box
331501	PH.1	50	42	20
331502	PH.2	50	42	20
331503	PH.3	50	42	20
331504	PH.4	50	46	20





**3/8" Slotted socket bit**

<b>333</b>		<i>l</i>		
Part no.	size	mm	g	pc/box
3335004	1.8x4	50	50	20
3335005	1.0x5	50	50	20
33350055	1.0x5.5	50	50	20
3335006	1.0x6	50	50	20
3335007	1.2x7	50	50	20
3335008	1.2x8	50	50	20









**3/8" Pozidriv socket bit**

<b>332</b>		<i>l</i>		
Part no.	size	mm	g	pc/box
332501	PZ.1	50	50	20
332502	PZ.2	50	50	20
332503	PZ.3	50	52	20
332504	PZ.4	50	52	20





**3/8" Hex socket bit**



<b>334</b>		<i>l</i>		
Part no.	size	mm	g	pc/box
33405003	3	50	42	20
33405004	4	50	42	20
33405005	5	50	43	20
334050055	5.5	50	43	20
33405006	6	50	43	20
33405007	7	50	47	20
33405008	8	50	47	20
33405009	9	50	52	20
33405010	10	50	57	20
33405012	12	50	66	20

<b>334</b>		<i>l</i>		
Part no.	size	mm	g	pc/box
3340501.8	1/8"	50	42	20
3340505.32	5/32"	50	42	20
3340503.16	3/16"	50	43	20
3340507.32	7/32"	50	43	20
3340501.4	1/4"	50	45	20
3340505.16	5/16"	50	47	20
3340503.8	3/8"	50	57	20
3340507.16	7/16"	50	62	20
3340501.2	1/2"	50	66	20
33405504	4	55	48	10
33406005	5	60	50	10
33406506	6	65	52	10
33407007	7	70	62	10
33407508	8	75	64	10
33408009	9	80	80	10
33408510	10	85	86	10
33409012	12	90	108	10
3340555.32	5/32"	55	48	10
3340603.16	3/16"	60	50	10
3340657.32	7/32"	65	52	10
3340701.4	1/4"	70	62	10
3340805.16	5/16"	80	80	10
3340803.8	3/8"	80	86	10
33408004	4	80	56	10
33408005	5	80	58	10
33408006	6	80	58	10
33408007	7	80	66	10
33408008	8	80	66	10
33408010	10	80	86	10
33408012	12	80	104	10
33410008	8	100	75	10
33413010	10	130	120	10
33418005	5	180	75	10
33422006	6	220	93	10

**3/8" Hex ball point socket bit**

<b>335</b>		<i>l</i>		
Part no.	size	mm	g	pc/box
33506203	3	62	48	10
33506204	4	62	48	10
33506205	5	62	54	10
33506206	6	62	54	10
33506207	7	62	58	10
33506208	8	62	58	10
33506210	10	62	68	10
33510003	3	100	56	10
33510004	4	100	56	10
33510005	5	100	62	10
33510006	6	100	62	10
33510007	7	100	66	10
33510008	8	100	74	10
33510010	10	100	94	10

**3/8" Star socket bit**

<b>336</b>		<i>l</i>		
Part no.	size	mm	g	pc/box
3365008	T8	50	50	20
3365010	T10	50	50	20
3365015	T15	50	50	20
3365020	T20	50	50	20
3365025	T25	50	50	20
3365027	T27	50	50	20
3365030	T30	50	50	20
3365040	T40	50	50	20
3365045	T45	50	52	20
3365050	T50	50	52	20
3365055	T55	50	62	20
3365060	T60	50	72	20



**3/8 Star tamperproof socket bit**

<b>337</b>		<i>l</i>		
Part no.	size	mm	g	pc/box
3375008	T-8H	50	42	20
3375010	T-10H	50	42	20
3375015	T-15H	50	42	20
3375020	T-20H	50	42	20
3375025	T-25H	50	42	20
3375027	T-27H	50	42	20
3375030	T-30H	50	43	20
3375040	T-40H	50	42	20
3375045	T-45H	50	46	20
3375050	T-50H	50	47	20
3375055	T-55H	50	55	20
3375060	T-60H	50	60	20



**3/8 Ribe socket bit**

<b>339</b>		<i>l</i>		
Part no.	size	mm	g	pc/box
33905007	M7	50	50	20
33905010	M10	50	55	20
33909005	M5	90	58	10
33909006	M6	90	60	10
33909007	M7	90	63	10
33909008	M8	90	64	10
33909009	M9	90	81	10
33909010	M10	90	83	10
33920007	M7	200	102	10
33924008	M8	240	129	10



**3/8 Spline socket bit**

<b>338</b>		<i>l</i>		
Part no.	size	mm	g	pc/box
3385005	M5	50	50	20
3385006	M6	50	50	20
3385008	M8	50	52	20
3385009	M9	50	54	20
3385010	M10	50	54	20
3385012	M12	50	56	20
3388808	M8	88	68	10
3388909	M9	89	86	10
3388910	M10	89	86	10



**3/8 Five-sided star tamperproof socket bit**

<b>33F</b>		<i>l</i>		
Part no.	size	mm	g	pc/box
33F5045	TS45	50	52	20
33F5050	TS50	50	52	20



**3/8" DR. 6pt. Flank socket**

<b>535</b>				
Part no.	size	mm	g	pc/box
53506	6	28	22	20
53507	7	28	23	20
53508	8	28	24	20
53509	9	28	24	20
53510	10	28	24	20
53511	11	28	25	20
53512	12	28	25	20
53513	13	28	28	20
53514	14	30	36	20
53515	15	30	44	20
53516	16	30	44	20
53517	17	30	47	20
53518	18	30	47	20
53519	19	30	55	20
53520	20	30	66	20
53521	21	30	66	20
53522	22	32	74	20
53524	24	32	77	20
5351.4	1/4"	28	23	20
5355.16	5/16"	28	24	20
5353.8	3/8"	28	25	20
5357.16	7/16"	28	28	20
5351.2	1/2"	28	32	20
5359.16	9/16"	30	38	20
53519.32	19/32"	30	44	20
5355.8	5/8"	30	44	20
53511.16	11/16"	30	47	20
5353.4	3/4"	30	55	20
53525.32	25/32"	30	71	20
53513.16	13/16"	30	71	20
5357.8	7/8"	32	72	20

**3/8" DR. 6pt. Flank deep socket**



<b>53546</b>				
Part no.	size	mm	g	pc/box
5354608	8	46	29	20
5354610	10	46	34	20
5354612	12	46	38	20
5354613	13	46	43	20
5354614	14	46	54	20

**3/8" DR. 6pt. Flank deep socket**



<b>53563</b>				
Part no.	size	mm	g	pc/box
5356306	6	63	40	20
5356307	7	63	40	20
5356308	8	63	40	20
5356309	9	63	46	20
5356310	10	63	47	20
5356311	11	63	51	20
5356312	12	63	52	20
5356313	13	63	59	20
5356314	14	63	74	20
5356315	15	63	83	20
5356316	16	63	91	20
5356317	17	63	104	10
5356318	18	63	114	10
5356319	19	63	123	10
5356320	20	63	149	10
5356321	21	63	154	10
5356322	22	63	166	10
535635.16	5/16"	63	46	20
535633.8	3/8"	63	49	20
535637.16	7/16"	63	50	20
535631.2	1/2"	63	52	20
535639.16	9/16"	63	71	20
535635.8	5/8"	63	88	20
5356311.16	11/16"	63	106	10
535633.4	3/4"	63	123	10



**3/8" DR. Star socket**



<b>536</b>		<i>l</i>		
Part no.	size	mm	g	pc/box
53604	E4	28	22	20
53605	E5	28	23	20
53606	E6	28	23	20
53607	E7	28	23	20
53608	E8	28	23	20
53610	E10	28	24	20
53611	E11	28	25	20
53612	E12	28	26	20
53614	E14	28	27	20
53616	E16	28	30	20
53618	E18	28	36	20
53620	E20	28	46	20

**3/8" DR. Surface drive socket**

<b>537</b>		<i>l</i>		
Part no.	size	mm	g	pc/box
53706	6	28	22	20
53707	7	28	23	20
53708	8	28	24	20
53709	9	28	24	20
53710	10	28	24	20
53711	11	28	25	20
53712	12	28	25	20
53713	13	28	28	20
53714	14	30	36	20
53715	15	30	44	20
53716	16	30	44	20
53717	17	30	47	20
53718	18	30	47	20
53719	19	30	55	20
53720	20	30	66	20
53721	21	30	66	20
53722	22	32	74	20
53724	24	32	77	20
5371.4	1/4"	28	23	20
5375.16	5/16"	28	24	20
5373.8	3/8"	28	25	20
5377.16	7/16"	28	28	20
5371.2	1/2"	28	32	20
5379.16	9/16"	30	38	20
53719.32	19/32"	30	44	20
5375.8	5/8"	30	44	20
53711.16	11/16"	30	47	20
5373.4	3/4"	30	55	20
53725.32	25/32"	30	71	20
53713.16	13/16"	30	71	20
5377.8	7/8"	32	72	20



**3/8" DR. Star deep socket**

<b>536...</b>		<i>l</i>		
Part no.	size	mm	g	pc/box
5365504	E4	55	26	20
5365505	E5	55	29	20
5365506	E6	55	30	20
5365507	E7	55	34	20
5366308	E8	63	40	20
5366310	E10	63	45	20
5366311	E11	63	53	20
5366312	E12	63	57	20
5366314	E14	63	66	20
5366316	E16	63	78	20
5366318	E18	63	97	20





**3/8" DR. Surface drive deep socket**

**53763**

Part no.	size	mm	g	pc/box
5376308	8	63	40	20
5376310	10	63	45	20
5376311	11	63	53	20
5376312	12	63	57	20
5376313	13	63	61	20
5376314	14	63	66	20
5376315	15	63	70	20
5376317	17	63	78	20
5376319	19	63	97	20



**3/8" DR. 12pt. Flank socket**

**539**

Part no.	size	mm	g	pc/box
53906	6	28	23	20
53907	7	28	24	20
53908	8	28	24	20
53909	9	28	24	20
53910	10	28	24	20
53911	11	28	24	20
53912	12	28	24	20
53913	13	28	27	20
53914	14	30	36	20
53915	15	30	44	20
53916	16	30	44	20
53917	17	30	47	20
53918	18	30	47	20

539 Part no.	size	mm	g	pc/box
53919	19	30	55	20
53920	20	30	66	20
53921	21	30	66	20
53922	22	32	74	20
53924	24	32	77	20
5391.4	1/4"	28	23	20
5395.16	5/16"	28	24	20
5393.8	3/8"	28	25	20
5397.16	7/16"	28	28	20
5391.2	1/2"	28	32	20
5399.16	9/16"	30	38	20
53919.32	19/32"	30	44	20
5395.8	5/8"	30	44	20
53911.16	11/16"	30	47	20
5393.4	3/4"	30	55	20
53925.32	25/32"	30	71	20
53913.16	13/16"	30	71	20
5397.8	7/8"	32	72	20









**3/8" DR. 12pt. Flank deep socket**

**53963**

Part no.	size	mm	g	pc/box
5396306	6	63	50	20
5396307	7	63	50	20
5396308	8	63	54	20
5396309	9	63	54	20
5396310	10	63	66	20
5396311	11	63	66	20
5396312	12	63	66	20
5396313	13	63	82	20
5396314	14	63	82	20
5396315	15	63	88	20
5396316	16	63	102	20
5396317	17	63	120	20
5396318	18	63	130	20
5396319	19	63	138	20
5396320	20	63	176	20
5396321	21	63	194	20
5396322	22	63	220	20









**3/8" DR. Spline socket**

<b>53Q</b>							<i>l</i>		
Part no.	size	6point	12point	SAE	E-Torx	XZN	mm	g	pc/box
53Q06	6	•	•		E8	6	25	24	20
53Q07	7	•	•	9/32"		7	25	24	20
53Q08	8	•	•	5/16"	E10	8	25	24	20
53Q09	9	•	•	11/32"	E11	9	25	24	20
53Q10	10	•	•	3/8"	E12	10	25	24	20
53Q11	11	•	•	7/16"	E14	11	25	24	20
53Q12	12	•	•	15/32"		12	25	24	20
53Q13	13	•	•	1/2"	E16		25	32	20
53Q14	14	•	•	9/16"	E18	14	25	44	20
53Q15	15	•	•	19/32"			25	48	20
53Q16	16	•	•	5/8"	E20	16	25	60	20
53Q17	17	•	•				25	74	20
53Q18	18	•	•		E22	18	25	75	20
53Q19	19	•	•	3/4"	E24		25	90	20
53Q20	20	•	•	25/32"		20	25	92	20
53Q21	21	•	•	13/16"			25	95	20
53Q22	22	•	•	7/8"		22	25	100	20
53Q24	24	•	•	15/16"		24	25	105	20



**3/8" DR. Spline deep socket**

<b>53Q63</b>							<i>l</i>		
Part no.	size	6point	12point	SAE	E-Torx	XZN	mm	g	pc/box
53Q6306	6	•	•		E8	6	63	50	20
53Q6307	7	•	•	9/32"		7	63	50	20
53Q6308	8	•	•	5/16"	E10	8	63	54	20
53Q6309	9	•	•	11/32"	E11	9	63	54	20
53Q6310	10	•	•	3/8"	E12	10	63	66	20
53Q6311	11	•	•	7/16"	E14	11	63	66	20
53Q6312	12	•	•	15/32"		12	63	66	20
53Q6313	13	•	•	1/2"	E16		63	82	20
53Q6314	14	•	•	9/16"	E18	14	63	86	20
53Q6315	15	•	•	19/32"			63	88	20
53Q6316	16	•	•	5/8"	E20	16	63	105	20
53Q6317	17	•	•				63	120	20
53Q6318	18	•	•		E22	18	63	130	20
53Q6319	19	•	•	3/4"	E24		63	138	20
53Q6320	20	•	•	25/32"		20	63	176	20
53Q6321	21	•	•	13/16"			63	194	20
53Q6322	22	•	•	7/8"		22	63	220	20



**3/8 DR. Swivel handle**

<b>8013</b>	<i>l</i>		
Part no.	mm	g	pc/box
8013215	215-8.5"	307	10

\* Spare part available



**3/8 DR. Ratchet handle-24 teeth-Thin**

<b>80233</b>	<i>l</i>		
Part no.	mm	g	pc/box
80233	200	294	1

\* Spare part available



**3/8 DR. Ratchet handle-24 teeth**

<b>80232</b>	<i>l</i>		
Part no.	mm	g	pc/box
80232	215	354	1

\* Spare part available



**3/8 DR. Ratchet handle-24 teeth-Thin**

<b>80234</b>	<i>l</i>		
Part no.	mm	g	pc/box
80234	175	306	1

\* Spare part available



**3/8 DR. 72 teeth round ratchet handle**

<b>802322</b>	<i>l</i>		
Part no.	mm	g	pc/box
802322	210	300	1

\* Spare part available



**3/8 DR. Ratchet handle-24 teeth-RD**

<b>80235</b>	<i>l</i>		
Part no.	mm	g	pc/box
80235	175	332	1

\* Spare part available



**3/8 DR. 72 teeth flexible round ratchet handle**

<b>802323</b>	<i>l</i>		
Part no.	mm	g	pc/box
802323	225	404	1

\* Spare part available



**3/8 DR. Ratchet handle-32 teeth**

<b>80236</b>	<i>l</i>		
Part no.	mm	g	pc/box
80236	193	288	1

\* Spare part available



**3/8"DR. 72 teeth Ratchet handle**

<b>80239</b>	<i>l</i>		
Part no.	mm	g	pc/box
80239	195	248	1

\* Spare part available



**3/8"DR. Stubby ratchet handle**

<b>802319</b>	<i>l</i>		
Part no.	mm	g	pc/box
802319	120	250	1

\* Spare part available



**3/8"DR. Ratchet handle-24 teeth**

<b>802311</b>	<i>l</i>		
Part no.	mm	g	pc/box
802311	195	374	1

\* Spare part available



**3/8"DR. Gearless ratchet handle**

<b>802321</b>	<i>l</i>		
Part no.	mm	g	pc/box
802321	180	278	1



**3/8"DR. Ratchet handle-30 teeth**

<b>802315</b>	<i>l</i>		
Part no.	mm	g	pc/box
802315	175	324	1

\* Spare part available



**3/8"DR. Bit ratchet**

<b>8023...</b>	<i>l</i>			
Part no.	size	mm	g	pc/box
802302	For 1/4" bit	130	122	1
802305	For 5/16" bit	180	280	1
802307	For 10mm bit	180	285	1

\* Spare part available



**3/8"DR. Flexible ratchet handle**

<b>802318</b>	<i>l</i>		
Part no.	mm	g	pc/box
802318	260	460	1

\* Spare part available



**3/8"DR. Stubby bit ratchet**

<b>8023...S</b>	<i>l</i>			
Part no.	size	mm	g	pc/box
802302S	for 1/4" bit	120	210	1
802305S	for 5/16" bit	120	252	1
802307S	for 10mm bit	120	256	1

\* Spare part available



**3/8"DR. Flexible bit ratchet**

**8023...F**

Part no.	size	l mm	g	pc/box
802302F	for 1/4" bit	260	265	1
802305F	for 5/16" bit	265	395	1
802307F	for 10mm bit	265	400	1

\* Spare part available



**3/8"DR. Extension-Thin**

**8043...R**

Part no.	mm	g	pc/box
8043150R	150-6"	120	10
8043225R	225-9"	178	10
8043300R	300-12"	235	10



**3/8"DR. Sliding T handle**

**8033**

Part no.	mm	g	pc/box
8033165	165	182	10



**3/8"DR. Wobble extension**

**8043...W**

Part no.	mm	g	pc/box
8043044W	44-1.75"	45	10
8043075W	75-3"	67	10
8043150W	150-6"	120	10

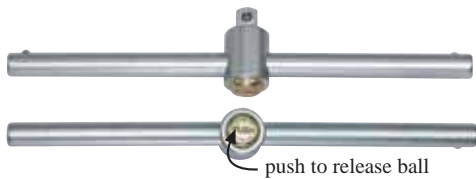

**3/8"DR. Locking Sliding T handle**

**8033200L**

Part no.	mm	g	pc/box
8033200L	200-8"	184	10



**3/8"DR. Universal joint**

**80531**

Part no.	mm	g	pc/box
80531	46	61	10



**3/8"DR. Extension**

**8043**

Part no.	mm	g	pc/box
8043044	44-1.75"	41	10
8043075	75-3"	78	10
8043150	150-6"	148	10
8043225	225-9"	220	10
8043250	250-10"	242	10
8043300	300-12"	291	10





**3/8"DR. Universal socket**

<b>80535</b>				
Part no.	socket	mm	g	pc/box
8053510	10	42	64	10
8053511	11	42	66	10
8053512	12	42	67	10
8053513	13	42	67	10
8053514	14	42	70	10
8053515	15	42	77	10
8053516	16	42	78	10
8053517	17	42	82	10
8053518	18	42	92	10
8053519	19	42	92	10
805353.8	3/8"	42	64	10
805357.16	7/16"	42	66	10
805351.2	1/2"	42	67	10
805359.16	9/16"	42	67	10
805355.8	5/8"	42	78	10
8053511.16	11/16"	42	82	10
805353.4	3/4"	42	92	10



**3/8"DR. Star universal socket**

<b>80536</b>				
Part no.	socket	mm	g	pc/box
8053606	E6	42	52	10
8053607	E7	42	52	10
8053608	E8	42	56	10
8053610	E10	42	56	10
8053611	E11	42	60	10
8053612	E12	42	60	10
8053614	E14	42	62	10
8053616	E16	42	62	10



**Adaptor for 3/8"DR. Extension**

<b>806</b>				
Part no.	size	mm	g	pc/box
80633	3/8"(F)x3/8"(M)	35	38	20
80643	1/2"(F)x3/8"(M)	46	68	10



**3/8"DR. Universal deep socket**

<b>8053585</b>				
Part no.	socket	mm	g	pc/box
805358510	10	85	82	10
805358511	11	85	86	10
805358512	12	85	92	10
805358513	13	85	92	10
805358514	14	85	104	10
805358515	15	85	108	10
805358516	16	85	112	10
805358517	17	85	121	10
805358518	18	85	136	10
805358519	19	85	136	10
80535853.8	3/8"	85	82	10
80535857.16	7/16"	85	86	10
80535851.2	1/2"	85	92	10
80535859.16	9/16"	85	92	10
80535855.8	5/8"	85	112	10
805358511.16	11/16"	85	121	10
80535853.4	3/4"	85	136	10



**3/8"DR. Spark plug socket**

<b>8073</b>				
Part no.	size	mm	g	pc/box
807316	16mm	63	96	10
807318	18mm	63	125	10
807320.6	20.6mm	63	150	10



**3/8"DR. Magnetic spark plug socket**

<b>8073..M</b>				
Part no.	size	mm	g	pc/box
807316M	16mm	70	80	10
807318M	18mm	70	122	10
807320.6M	20.6mm	70	151	10



**3/8 DR. Locking extension**

<b>8083</b>	<i>l</i>		
Part no.	mm	g	pc/box
808306	150-6"	157	10
808310	250-10"	249	10
808312	300-12"	322	5
808318	450-18"	484	5



**3/8 DR. Adaptor**

<b>8093</b>	<i>l</i>			
Part no.	size	mm	g	pc/box
80932	3/8"(F) x 1/4"(M)	35	31	10
80934	3/8"(F) x 1/2"(M)	46	47	10



**3/8 Bit adaptor**

<b>809</b>	<i>l</i>			
Part no.	size	mm	g	pc/box
8095330	5/16"Hex-3/8" Sq.	30	16	20



**3/8 DR. Bit holder**

<b>8103</b>	<i>l</i>			
Part no.	size	mm	g	pc/box
81032	3/8"(F)x1/4"(F)	30	27	20
81035	3/8"(F)x5/16"(F)	30	38	20
81037	3/8"(F)x10mm(F)	30	38	20



**3/8 DR. Plastic hanger**

<b>8163</b>	<i>l</i>			
Part no.	size	mm	g	pc/box
8163	3/8"DR.	66	4	100



**3/8 DR. Speed T handle**

<b>8193T</b>	<i>l</i>		
Part no.	mm	g	pc/box
8193T	250	449	10





**3/8 DR. Socket rail**

<b>8193...</b>				
Part no.	PCS	L(mm)	WT(gw)	pc/box
819307	7	160	26	10
819313	13	280	46	10
819320	20	560	126	10





**4pc Star socket bit set**

<b>4041</b>			
Part no.	Bit	20/17.0/18.0/0.82'	850g
Content: 1/2"DR.			
2-Star socket bit			
346120 40...45	T40; T45 (120mmL)		
346140 50...55	T50; T55 (140mmL)		





**5pc Star socket bit set**

<b>4051</b>			
Part no.	Bit	30/19.3/20.3/0.9'	643g
Content: 1/2"DR.			
5-Star socket bit			
346055 40...60	T40; T45; T50; T55; T60 (55mmL)		





**4pc Star socket bit set**

<b>4042</b>			
Part no.	Bit	40/20.6/21.6/1.4'	515g
Content: 1/2"DR.			
4-Star socket bit			
346100 40...70	T40; T45; T55; T70 (100mmL)		



**5pc 1/2" Hex socket bit set**

<b>4056</b>			
Part no.	Bit	20/17.0/18.0/1'	850g
Content: 1/2"DR.			
5-Hex socket bit			
344055 10...12	10; 12 mm (55mmL)		
34406514	14 mm (65mmL)		
344070 17...19	17; 19 mm (70mmL)		



**5pc Accessory set**

<b>4057</b>		
Part no.	6/15.0/16.0/0.9'	2500g
	Content: 1/2"DR.	
80249	1-72 teeth ratchet handle	
8044 125...250	2-Extension bar 5"; 10"	
8034250	1-Sliding T handle	
80541	1-Universal joint	



**6pc 1/2" Spline socket bit set**

<b>4061</b>		
Part no.	20/21.0/22.0/0.82'	1050g
	Content: 1/2"DR.	
	6-Spline socket bit	
348055 06...10	M6; M8; M10 (55mmL)	
348100 08...12	M8; M10; M12 (100mmL)	



**5pc Specialty set**

<b>4059</b>		
Part no.	20/13.0/14.0/1.3	650g
	Content: 1/2"DR.	
348140 08...12	3-1/2" Spline socket bit M8; M10; M12 (140mmL)	
34413008	1-1/2" Hex socket bit 8mm (130mmL)	
34410508B	1-1/2" Bent hex socket bit 8mm (105mmL)	





**6pc Star socket bit set**

<b>4062</b>			
Part no.	Bit	25/15.8/16.8/0.64'	632g
	Content: 1/2"DR.		
	6-Star socket bit (55mmL)		
346055 25...55	T25; T30; T40; T45; T50; T55		





**6pc 10mm Spline bit set**

<b>4066</b>			
Part no.	Bit	100/13.0/14.0/3.1'	130g
	Content: 1/2"DR.		
17830 05...12	5-10mm spline bit (30mmL) M5; M6; M8; M10; M12		
81047	1-Bit holder 1/2"DR.x10mm		





**6pc Accessory set**

<b>40613</b>		
Part no.	6/16.5/17.5/0.9'	2750g
	Content: 1/2"DR.	
802418	1-Flexible ratchet handle	
8044 125...250	2-Extension bar 5"; 10"	
8034250	1-Sliding T handle	
80541	1-Universal joint	
8014380	1-Swivel handle 15"	





**6pc Accessory set**

<b>40612</b>		
Part no.	6/16.5/17.5/0.9'	2750g
	Content: 1/2"DR.	
802415	1-Ratchet handle	
8044 125...250	2-Extension bar 5"; 10"	
8034250	1-Sliding T handle	
80541	1-Universal joint	
8014380	1-Swivel handle 15"	



**6pc Accessory set**

<b>40613-23</b>		
Part no.	6/16.5/17.5/0.9'	2750g
	Content: 1/2"DR.	
802423	1-72 teeth flexible round ratchet handle	
8044 125...250	2-Extension bar 5"; 10"	
8034250	1-Sliding T handle	
80541	1-Universal joint	
8014380	1-Swivel handle 15"	





**7pc Star socket set**

<b>4071</b>			
Part no.	Socket	20/20.0/21.0/1.1'	1000g
546 10...24	Content: 1/2"DR. 7-Star socket E10; E12; E14; E16; E18; E20; E24		

**7pc 10mm Hex bit set**

<b>4075</b>			
Part no.	Bit	100/14.0/15.0/3.1'	140g
17430 04...12 81047	Content: 1/2"DR. 6-10mm hex bit (30mmL) 4; 5; 6; 8; 10; 12 mm 1-Bit holder 1/2"DR.x10mm		



**7pc 10mm Spline bit set**

<b>4072</b>			
Part no.	Bit	60/16.5/17.5/1.3'	275g
17830 06...10 17875 08...12 81047	Content: 1/2"DR. 6-10mm Spline bit M6; M8; M10 (30mmL) M8; M10; M12 (75mmL) 1-Bit holder 1/2"DR.x10mm		

**8pc 10mm Star bit set**

<b>4081</b>			
Part no.	Bit	100/19.0/20.0/1.6'	190g
17630 20...55 81047	Content: 1/2"DR. 7-10mm Star bit (30mmL) T20; T25; T30; T40; T45; T50; T55 1-Bit holder 1/2"DR.x10mm		



**7pc 10mm Star bit set**

<b>4074</b>			
Part no.	Bit	100/14.0/15.0/3.1'	140g
17630 25...55 81047	Content: 1/2"DR. 6-10mm Star bit (30mmL) T25; T30; T40; T45; T50; T55 1-Bit holder 1/2"DR.x10mm		



<b>4081-3</b>			
Part no.	Bit	100/19.0/20.0/1.6'	190g
81037	Content: 3/8"DR. 1-Bit holder 3/8"DR.x10mm		



**8pc 1/2" Deep socket set (MM)**



<b>4082</b>			
Part no.	Socket	12/17.3/18.3/1'	1440g
54577 13...24	Content: 1/2"DR. 8-6pt. Flank deep socket (77mmL) 13; 14; 15; 17; 19; 21; 22; 24 mm		

**8pc 1/2" Deep socket set (SAE)**



<b>4082S</b>			
Part no.	Socket	12/17.3/18.3/1'	1440g
54577 1.2...15.16	Content: 1/2"DR. 8-6pt. Flank deep socket (77mmL) 1/2"; 9/16"; 5/8"; 11/16"; 3/4"; 13/16"; 7/8"; 15/16"		



**8pc 1/2" Universal deep socket set (MM)**



<b>4084</b>			
Part no.	Socket	15/28.5/29.5/1'	1900g
80545108 13...24	Content: 1/2"DR. 8-Universal deep socket 13; 14; 15; 17; 19; 21; 22; 24 mm		

**8pc 1/2" Universal deep socket set (SAE)**

<b>4084S</b>			
Part no.	Socket	15/28.5/29.5/1'	1900g
80545108 1.2...15.16	Content: 1/2"DR. 8-Universal deep socket 1/2"; 9/16"; 5/8"; 11/16"; 3/4"; 13/16"; 7/8"; 15/16"		





**8pc Star deep socket set**



<b>4083</b>			
Part no.	Socket	12/13.5/14.5/1'	1125g
54677 10...24	Content: 1/2"DR. 8-Star deep socket (77mmL) E10; E11; E12; E14; E16; E18; E20; E24		



**8pc 1/2" Universal socket set (MM)**



<b>4085</b>			
Part no.	Socket	15/22.5/23.5/1'	1500g
80545 13...24	Content: 1/2"DR. 8-Universal socket 13; 14; 15; 17; 19; 21; 22; 24 mm		

**8pc 1/2" Universal socket set (SAE)**



<b>4085S</b>			
Part no.	Socket	15/22.5/23.5/1'	1500g
80545 1.2...15.16	Content: 1/2"DR. 8-Universal socket 1/2"; 9/16"; 5/8"; 11/16"; 3/4"; 13/16"; 7/8"; 15/16"		





**8pc 1/2" Hex socket bit set (MM)**

<b>4091</b>			
Part no.	Bit	20/22.5/23.5/0.82'	1125g
344055 05...12	Content: 1/2"DR. 8-Hex socket bit 5; 6; 7; 8; 10; 12 mm (55mmL)		
34406514	14 mm (65mmL)		
34407017	17 mm (70mmL)		

**8pc 1/2" Hex socket bit set (SAE)**

<b>4091S</b>			
Part no.	Bit	20/22.5/23.5/0.82'	1125g
344055 5.32...1.2	Content: 1/2"DR. 8-Hex socket bit 5/32"; 3/16"; 1/4"; 5/16"; 3/8"; 1/2" (55mmL)		
344065 9.16...5.8	9/16"; 5/8" (70mmL)		

**8pc 1/2" Adapter set**

<b>K4087</b>			
Part no.	ADAPTER	24/26.5/27.5/1.5'	1750g
809 23...86	Content: 1/2"DR. 8-Adapter 1/4"(F)x3/8"(M); 3/8"(F)x1/4"(M); 3/8"(F)x1/2"(M); 1/2"(F)x3/8"(M); 1/2"(F)x3/4"(M); 3/4"(F)x1/2"(M); 3/4"(F)x1"(M); 1"(F)x3/4"(M)		





8pc 1/2" Hex socket bit set (MM)			
<b>4092</b>			
Part no.	Bit	10/19.8/20.8/1'	1980g
344110 05...17	Content: 1/2"DR. 8-Hex socket bit (110mmL) 5; 6; 7; 8; 10; 12; 14; 17 mm		



9pc Star socket set			
<b>4093</b>			
Part no.	Socket	20/24.0/25.0/1.1'	1200g
546 10...24	Content: 1/2"DR. 9-Star socket E10; E11; E12; E14; E16; E18; E20; E22; E24		



9pc Star socket set			
<b>4095</b>			
Part no.	Socket	36/23.3/24.3/1.6'	647g
536 10...14 546 16...24	Content: 3/8" & 1/2"DR. 9-Star socket 3/8"DR.: E10; E11; E12; E14; 1/2"DR.: E16; E18; E20; E22; E24		





9pc 1/2" Hex socket bit set (MM)			
<b>4101</b>			
Part no.	Bit	15/20.0/21.0/1'	1334g
344055 04...12 34406514 34407017	Content: 1/2"DR. 9-Hex socket bit 4; 5; 6; 7; 8; 10; 12 mm (55mmL) 14 mm (65mmL) 17 mm (70mmL)		

9pc 1/2" Hex socket bit set (SAE)			
<b>4101S</b>			
Part no.	Bit	15/20.0/21.0/1'	1334g
344055 5.32...1.2 344065 9.16...5.8	Content: 1/2"DR. 9-Hex socket bit 5/32"; 3/16"; 7/32"; 1/4"; 5/16"; 3/8"; 1/2" (55mmL) 9/16"; 5/8" (65mmL)		







**9pc Star socket bit set**

<b>4102</b>			
Part no.	Bit	20/22.0/23.0/0.82'	1100g
346055 20...60	Content: 1/2"DR. 9-Star socket bit T20; T25; T27; T30; T40; T45; T50; T55; T60 (55mmL)		





**10pc Spline deep socket set**



<b>41014Q</b>			
Part no.	Socket	24/36.0/37.0/1.4'	1500g
54Q77 10...24	Content: 1/2"DR. 10-Spline deep socket (77mmL) 10; 11; 12; 13; 14; 15; 17; 19; 22; 24 mm		



**10pc 1/2" Hex socket bit set (MM)**

<b>4106</b>			
Part no.	Socket	20/16.0/17.0/1.3'	800g
545 11...24	Content: 1/2"DR. 10-1/2" 6pt. Flank socket 11; 12; 13; 14; 15; 17; 19; 21; 22; 24 mm		

**10pc 1/2" Hex socket bit set (SAE)**

<b>4111</b>			
Part no.	Bit	15/23.4/24.4/1'	1560g
344055 04...12 34406514 344070 17...19	Content: 1/2"DR. 10-Hex socket bit 4; 5; 6; 7; 8; 10; 12 mm (55mmL) 14 mm (65mmL) 17; 19 mm (70mmL)		

**10pc 1/2" Hex socket bit set (SAE)**



<b>4106S</b>			
Part no.	Socket	20/16.0/17.0/1.3'	800g
545 3.8...15.16	Content: 1/2"DR. 10-1/2" 6pt. Flank socket 3/8"; 7/16"; 1/2"; 9/16"; 5/8"; 11/16"; 3/4"; 13/16"; 7/8"; 15/16"		

<b>4111S</b>			
Part no.	Bit	15/23.4/24.4/1'	1560g
344055 5.32...1.2 344065 9.16...5.8 3440703.4	Content: 1/2"DR. 10-Hex socket bit 5/32"; 3/16"; 7/32"; 1/4"; 5/16"; 3/8"; 1/2" (55mmL) 9/16"; 5/8" (65mmL) 3/4" (70mmL)		







**11pc 10mm Spline bit set**

<b>4112</b>			
Part no.	Bit	20/10.3/11.3/0.82'	515g
Content: 1/2"DR.			
10-10mm Spline bit			
17830 05...12	M5; M6; M8; M10; M12 (30mmL)		
17875 05...12	M5; M6; M8; M10; M12 (75mmL)		
81047	1-Bit holder 1/2"DR.x10mm		





**11pc Star socket set**

<b>4113</b>			
Part no.	Socket	36/16.5/17.5/1.6'	458g
Content: 1/4" & 3/8" & 1/2"DR.			
11-Star socket			
526 05...08	1/4"DR.: E5; E6; E7; E8		
536 10...14	3/8"DR.: E10; E11; E12; E14		
546 16...20	1/2"DR.: E16; E18; E20		





**11pc Socket bit set**

<b>4116</b>		
Part no.	6/13.5/14.5/0.9'	2250g
Content: 1/2"DR.		
5-Hex socket bit		
344 18005...14010	5mm (180mmL); 6mm (160mmL); 7mm (100mmL); 8mm (120mmL); 10mm (140mmL)	
3-Star socket bit		
346140 45...55	T45; T55 (140mmL)	
34610070	T70 (100mmL)	
3-Spline socket bit		
348100 08...10	M8 (100mmL); M10 (120mmL)	
34814012	M12 (140mmL)	





**12pc Socket bit set**

<b>4122</b>		
Part no.	6/13.0/14.0/0.9'	2160g
Content: 1/2"DR.		
4-Hex socket bit		
34418005	5mm (180mmL)	
344100 06...08	6; 7; 8 mm (100mmL)	
4-Star Socket bit		
346120 40...45	T40; T45 (120mmL)	
346140 55...70	T55; T70 (140mmL)	
4-Spline socket bit		
348100 06...12	M6; M8; M10; M12 (100mmL)	









**12pc Spline socket set**

<b>4124Q</b>			
Part no.	Socket	36/29.0/30.0/1.6'	806g
54Q 10...24	Content: 1/2"DR. 12-Spline socket 10; 11; 12; 13; 14; 15; 16; 17; 19; 21; 22; 24 mm		





**14pc 1/2" Deep socket set**

<b>4143</b>			
Part no.	Socket	6/18.6/19.6/0.9'	3100g
54577 10...32	Content: 1/2"DR. 14-6pt. Flank deep socket 10; 12; 13; 14; 15; 17; 19; 21; 22; 23; 24; 27; 30; 32 mm		
<b>4143-9</b>			
Part no.	Socket	6/18.6/19.6/0.9'	3100g
54977 10...32	Content: 1/2"DR. 14-12pt. Flank deep socket 10; 12; 13; 14; 15; 17; 19; 21; 22; 23; 24; 27; 30; 32 mm		





**13pc Hex socket bit set**

<b>4141</b>			
Part no.	Bit	6/21.0/22.0/0.9'	3500g
344055 04...12 34406514 344070 17...19 80243 8044125 8034300 80541	Content: 1/2"DR. 9-Hex socket bit 4; 5; 6; 8; 10; 12 mm (55mmL) 14 mm (65mmL) 17; 19 mm (70mmL) 1-Ratchet handle 1-Extension bar 5" 1-Sliding T handle 12" 1-Universal joint		



**15pc 10mm Hex bit set**

<b>4155</b>			
Part no.	Bit	20/16.0/17.0/0.82'	800g
17430 04...12 17475 04...12 81047	Content: 1/2"DR. 14-10mm Hex bit 4; 5; 6; 7; 8; 10; 12 mm (30mmL) 4; 5; 6; 7; 8; 10; 12 mm (75mmL) 1-Bit holder 1/2"DR.x10mm		



**15pc 10mm Star bit set**

<b>4156</b>			
Part no.	Bit	20/16.0/17.0/0.82'	800g
17630 20...55	Content: 1/2"DR. 7-10mm Star bit (30mmL) T20; T25; T30; T40; T45; T50; T55		
17675 20...55	7-10mm Star bit (75mmL) T20; T25; T30; T40; T45; T50; T55		
81047	1-Bit holder 1/2"DR.x10mm		



**14pc Star set**

<b>4157</b>			
Part no.	Bit	20/18.0/19.0/0.82'	900g
546 10...20	Content: 1/2"DR. 6-Star socket E10; E12; E14; E16; E18; E20		
17630 25...55	7-10mmL Star bit (30mmL) T25; T27; T30; T40; T45; T50; T55		
81047	1-Bit holder 1/2"DR.x10mm		



**14pc Star socket set**

<b>4158</b>			
Part no.	Socket	20/13.0/14.0/1'	650g
526 04...08	Content: 1/4" & 3/8" & 1/2"DR. 5-1/4"DR. Star socket E4; E5; E6; E7; E8		
536 10...14	4-3/8"DR. Star socket E10; E11; E12; E14		
546 16...24	5-1/2"DR. Star socket E16; E18; E20; E22; E24		



**16pc Socket set**

<b>4161</b>			
Part no.	Socket	6/20.8/21.8/0.68'	3466g
545 10...27	Content: 1/2"DR. 13-6pt. Flank socket 10; 11; 12; 13; 14; 15; 17; 19; 21; 22; 24; 26; 27 mm		
80244	1-Ratchet handle		
8044125	1-Extension bar 5"		
8014380	1-Swivel handle 15"		
<b>4161-7</b>			
Part no.	Socket	6/20.8/21.8/0.68'	3466g
Changed Items	Content: 1/2"DR.		
547 10...27	13-Surface drive socket 10; 11; 12; 13; 14; 15; 17; 19; 21; 22; 24; 26; 27 mm		
<b>4161-9</b>			
Part no.	Socket	6/20.8/21.8/0.68'	3466g
Changed Items	Content: 1/2"DR.		
549 10...27	13-12pt. Flank socket 10; 11; 12; 13; 14; 15; 17; 19; 21; 22; 24; 26; 27 mm		



**16pc Socket set**

<b>4162</b>			
Part no.	Socket	6/21.0/22.0/0.7'	3500g
549 10...32	Content: 1/2"DR. 12-12pt. Flank socket 10; 11; 12; 13; 14; 17; 19; 22; 24; 27; 30; 32 mm		
80242	1-Ratchet handle		
8034300	1-Sliding T handle 12"		
8044125	1-Extension bar 5"		
80541	1-Universal joint		
<b>4162-5</b>			
Part no.	Socket	6/21.0/22.0/0.7'	3500g
Changed Items 545 10...32	Content: 1/2"DR. 12-6pt. Flank socket 10; 11; 12; 13; 14; 17; 19; 22; 24; 27; 30; 32 mm		
<b>4162-7</b>			
Part no.	Socket	6/21.0/22.0/0.7'	3500g
Changed Items 547 10...32	Content: 1/2"DR. 12-Surface drive socket 10; 11; 12; 13; 14; 17; 19; 22; 24; 27; 30; 32 mm		



**16pc Star set**



<b>4171</b>			
Part no.	Bit	10/20.0/21.0/0.7'	2000g
546 10...24	Content: 1/2"DR. 9-Star socket E10; E11; E12; E14; E16; E18; E20; E22; E24		
346055 30...70	7-Star socket bit (55mmL) T30; T40; T45; T50; T55; T60; T70		
<b>4172</b>			
Part no.	Bit	10/20.0/21.0/0.7'	2000g
546 10...24	Content: 1/2"DR. 9-Star socket E10; E11; E12; E14; E16; E18; E20; E22; E24		
346055 40...70	7-Star socket bit (55mmL) T40; T45; T47; T50; T55; T60; T70		











**17pc Socket set (MM)**



<b>4173</b>			
Part no.	Socket	6/16.0/17.0/0.7'	2660g
547 08...26	Content: 1/2"DR. 13-Surface drive socket 8; 10; 11; 12; 13; 14; 15; 16; 17; 19; 21; 23; 26 mm		
80243	1-Ratchet handle		
807420.6	1-Spark plug socket 20.6mm		
8034250	1-Sliding T handle		
8044125	1-Extension bar 5"		



<b>4173-5</b>			
Part no.	Socket	6/16.0/17.0/0.7'	2660g
545 08...26	Content: 1/2"DR. 13-6pt. Flank socket 8; 10; 11; 12; 13; 14; 15; 16; 17; 19; 21; 23; 26 mm		

<b>4173-9</b>			
Part no.	Socket	6/16.0/17.0/0.7'	2660g
549 08...26	Content: 1/2"DR. 13-12pt. Flank socket 8; 10; 11; 12; 13; 14; 15; 16; 17; 19; 21; 23; 26 mm		

**17pc Socket set (SAE)**



<b>4173S</b>			
Part no.	Socket	6/16.0/17.0/0.7'	2660g
547 5.16...1	Content: 1/2"DR. 13-Surface drive socket 5/16"; 3/8"; 7/16"; 15/32"; 1/2"; 9/16"; 19/32"; 5/8"; 11/16"; 3/4"; 13/16"; 7/8"; 1"		



<b>4173S-5</b>			
Part no.	Socket	6/16.0/17.0/0.7'	2660g
545 5.16...1	Content: 1/2"DR. 13-6pt. Flank socket 5/16"; 3/8"; 7/16"; 15/32"; 1/2"; 9/16"; 19/32"; 5/8"; 11/16"; 3/4"; 13/16"; 7/8"; 1"		

<b>4173S-9</b>			
Part no.	Socket	6/16.0/17.0/0.7'	2660g
545 5.16...1	Content: 1/2"DR. 13-12pt. Flank socket 5/16"; 3/8"; 7/16"; 15/32"; 1/2"; 9/16"; 19/32"; 5/8"; 11/16"; 3/4"; 13/16"; 7/8"; 1"		





**17pc Socket set**

<b>4181</b>			
Part no.	Socket	6/19.5/20.5/0.7'	3250g
545 10...26	Content: 1/2"DR. 13-6pt. Flank socket 10; 11; 12; 13; 14; 15; 16; 17; 18; 19; 21; 23; 26 mm		
80244	1-Ratchet handle		
8044125	1-Extension bar 5"		
8034250	1-Sliding T handle		
807420.6	1-Spark plug socket 20.6mm		



<b>4181-7</b>			
Part no.	Socket	6/19.5/20.5/0.7'	3250g
547 10...26	Content: 1/2"DR. 13-Surface drive socket 10; 11; 12; 13; 14; 15; 16; 17; 18; 19; 21; 23; 26 mm		



<b>4181-9</b>			
Part no.	Socket	6/19.5/20.5/0.7'	3250g
Changed Items	Content: 1/2"DR.		
549 10...26	13-12pt. Flank socket 10; 11; 12; 13; 14; 15; 16; 17; 18; 19; 21; 23; 26 mm		











**18pc Star set**

<b>4192</b>			
Part no.	Bit	10/16.5/17.5/0.7'	1650g
	Content: 3/8" & 1/2"DR.		
536 10...18	6-3/8"DR. Star socket E10; E11; E12; E14; E16; E18		
546 20...24	3-1/2"DR. Star socket E20; E22; E24		
33650 20...40	5-3/8"DR. Star socket bit T20; T25; T27; T30; T40 (50mmL)		
346055 45...60	4-1/2"DR. Star socket bit T45; T50; T55; T60 (55mmL)		





**19pc 1/2" Socket set**









<b>4194</b>			
Part no.	Socket	6/14.8/15.8/0.9'	2470g
	Content: 1/2"DR.		
545 5.16...1.1.4	19-6pt. Flank socket 5/16"; 3/8"; 7/16"; 15/32"; 1/2"; 9/16"; 19/32"; 5/8"; 11/16"; 3/4"; 25/32"; 13/16"; 7/8"; 15/16"; 1"; 1-1/16"; 1-1/8"; 1-3/16"; 1-1/4"		
<b>4194-7</b>			
Part no.	Socket	6/14.8/15.8/0.9'	2470g
Changed Items	Content: 1/2"DR.		
547 5.16...1.1.4	19-Surface drive socket 5/16"; 3/8"; 7/16"; 15/32"; 1/2"; 9/16"; 19/32"; 5/8"; 11/16"; 3/4"; 25/32"; 13/16"; 7/8"; 15/16"; 1"; 1-1/16"; 1-1/8"; 1-3/16"; 1-1/4"		
<b>4194-9</b>			
Part no.	Socket	6/14.8/15.8/0.9'	2470g
Changed Items	Content: 1/2"DR.		
549 5.16...1.1.4	19-12pt. Flank socket 5/16"; 3/8"; 7/16"; 15/32"; 1/2"; 9/16"; 19/32"; 5/8"; 11/16"; 3/4"; 25/32"; 13/16"; 7/8"; 15/16"; 1"; 1-1/16"; 1-1/8"; 1-3/16"; 1-1/4"		





**20pc Star set**



<b>4211</b>			
Part no.	Bit	15/15.4/16.4/1'	1026g
	Content: 1/4" & 1/2"DR.		
546 10...14	3-1/2"DR. Star socket E10; E12; E14		
346055 40...60	5-1/2"DR. Star socket bit T40; T45; T50; T55; T60 (55mmL)		
12630 06...09	4-1/4" Star bit T6; T7; T8; T9 (30mmL)		
12730 10G...30G	6-1/4" Star tamperproof bit T-10H; T-15H; T-20H; T-25H; T-27H; T-30H (30mmL)		
8145	1-1/4"DR. Spinner		
81022	1-Bit holder 1/4"DR.x1/4"		



**21pc Socket set**



<b>4212</b>			
Part no.	Socket	6/16.0/17.0/0.9'	2666g
	Content: 1/2"DR.		
545 08...32	21-6pt. Flank socket 8; 10; 11; 12; 13; 14; 15; 16; 17; 18; 19; 20; 21; 22; 23; 24; 26; 27; 28; 30; 32 mm		
<b>4212-7</b>			
Part no.	Socket	6/16.0/17.0/0.9'	2666g
Changed Items	Content: 1/2"DR.		
547 08...32	21-Surface drive socket 8; 10; 11; 12; 13; 14; 15; 16; 17; 18; 19; 20; 21; 22; 23; 24; 26; 27; 28; 30; 32 mm		
<b>4212-9</b>			
Part no.	Socket	6/16.0/17.0/0.9'	2666g
Changed Items	Content: 1/2"DR.		
549 08...32	21-12pt. Flank socket 8; 10; 11; 12; 13; 14; 15; 16; 17; 18; 19; 20; 21; 22; 23; 24; 26; 27; 28; 30; 32 mm		



20pc Star set			
<b>4213</b>			
Part no.	Bit	6/19.5/20.5/0.9'	3167g
Content: 1/2"DR.			
346055 20...60	10-20-Star socket bit	T20; T25; T27; T30; T40; T45; T47; T50; T55; T60 (55mmL)	
546 08...20	7-Star socket	E8; E10; E12; E14; E16; E18; E20	
80243	1-Ratchet handle		
8044125	1-Extension bar 5"		
80541	1-Universal joint		



21pc Socket set			
<b>4214</b>			
Part no.	Socket	6/20.0/21.0/0.9'	3330g
Content: 1/2"DR.			
545 08...26	15-6pt. Flank socket	8; 10; 11; 12; 13; 14; 15; 16; 17; 18; 19; 21; 22; 23; 26 mm	
80249	1-72 teeth ratchet handle		
8044 125...250	2-Extension bar 5" & 10"		
80541	1-Universal joint		
80634	1-Adaptor for extension	3/8"(F)x1/2"(M)	
807420.6	1-Spark plug socket 20.6mm		

<b>4214-7</b>			
Part no.	Socket	6/20.0/21.0/0.9'	3330g
Content: 1/2"DR.			
Changed Items			
547 08...26	15-Surface drive socket	8; 10; 11; 12; 13; 14; 15; 16; 17; 18; 19; 21; 22; 23; 26 mm	









<b>4214-9</b>			
Part no.	Socket	6/20.0/21.0/0.9'	3330g
Content: 1/2"DR.			
Changed Items			
549 08...26	15-12pt. Flank socket	8; 10; 11; 12; 13; 14; 15; 16; 17; 18; 19; 21; 22; 23; 26 mm	





**22pc Star tamperproof bit set**

<b>4222</b>			
Part no.	Bit	15/15.5/16.5/1'	1033g
	Content: 3/8" & 1/2"DR.		
17730 10...55	20-10mm star tamperproof bit T-10H; T-15H; T-20H; T-25H; T-27H; T-30H; T-40H; T-45H; T-50H; T-55H (30mmL)		
17775 10...55	T-10H; T-15H; T-20H; T-25H; T-27H; T-30H; T-40H; T-45H; T-50H; T-55H (75mmL)		
810 37...47	2-Bit holder 3/8"DR.x10mm; 1/2"DR.x10mm		



**22pc Socket bit set**

<b>4223</b>			
Part no.	Socket	5/19.3/20.3/1.4'	3860g
	Content: 1/2"DR.		
545 10...32	15-6pt. Flank Socket 10; 11; 12; 13; 14; 15; 16; 17; 18; 19; 22; 24; 27; 30; 32 mm		
80243	1-Ratchet handle		
8044 125...250	2-Extension bar 5" ; 10"		
8074 16...20.6	1-Spark plug socket 16 ; 20.6 mm		
80541	1-Universal joint		
80634	1-Adaptor for extension 3/8"(F)x1/2"(M)		
<b>4223-7</b>			
Part no.	Socket	5/19.3/20.3/1.4'	3860g
Changed Items	Content: 1/2"DR.		
547 10...32	15-Surface drive Socket 10; 11; 12; 13; 14; 15; 16; 17; 18; 19; 22; 24; 27; 30; 32 mm		
<b>4223-9</b>			
Part no.	Socket	5/19.3/20.3/1.4'	3860g
Changed Items	Content: 1/2"DR.		
549 10...32	15-12pt. Flank Socket 10; 11; 12; 13; 14; 15; 16; 17; 18; 19; 22; 24; 27; 30; 32 mm		





**22pc Ribe bit set**

<b>4225</b>			
Part no.	Bit	15/18.2/19.2/1'	1230g
	Content: 3/8" & 1/2"DR. 20-10mm Ribe bit		
17930 04...14	M4; M5; M6; M7; M8; M9; M10; M12; M13; M14 (30mmL)		
17975 04...14	M4; M5; M6; M7; M8; M9; M10; M12; M13; M14 (75mmL)		
810 37...47	2-Bit holder 3/8"DR.x10mm; 1/2"DR.x10mm		



**24pc Socket set (MM)**

<b>4243</b>			
Part no.	Socket	4/22.0/23.0/0.9'	5500g
	Content: 1/2"DR.		
547 10...32	18-Surface drive socket 10; 11; 12; 13; 14; 15; 16; 17; 18; 19; 20; 21; 22; 23; 24; 27; 30; 32 mm		
80243	1-Ratchet handle		
8014380	1-Swivel handle 15"		
8044 125...250	2-Extension bar 5" ; 10"		
8034250	1-Sliding T handle		
80541	1-Universal joint		









**4243-5**

<b>4243-5</b>			
Part no.	Socket	4/22.0/23.0/0.9'	5500g
Changed Items	Content: 1/2"DR.		
545 10...32	18-6pt. Flank socket 10; 11; 12; 13; 14; 15; 16; 17; 18; 19; 20; 21; 22; 23; 24; 27; 30; 32 mm		









**4243-9**

<b>4243-9</b>			
Part no.	Socket	4/22.0/23.0/0.9'	5500g
Changed Items	Content: 1/2"DR.		
549 10...32	18-12pt. Flank socket 10; 11; 12; 13; 14; 15; 16; 17; 18; 19; 20; 21; 22; 23; 24; 27; 30; 32 mm		









<b>22pc Socket set (SAE)</b>			
<b>4243S</b>			
Part no.	Socket	4/22.0/23.0/0.9'	5500g
Changed Items 547 5.16...1.1.4	Content: 1/2"DR. 18-Surface drive socket 5/16"; 3/8"; 7/16"; 1/2"; 9/16"; 19/32"; 5/8"; 11/16"; 3/4"; 25/32"; 13/16"; 7/8"; 15/16"; 1"; 1-1/16"; 1-1/8"; 1-3/16"; 1-1/4"		
<b>4243S-5</b>			
Part no.	Socket	4/22.0/23.0/0.9'	5500g
Changed Items 545 5.16...1.1.4	Content: 1/2"DR. 18-6pt. Flank socket 5/16"; 3/8"; 7/16"; 1/2"; 9/16"; 19/32"; 5/8"; 11/16"; 3/4"; 25/32"; 13/16"; 7/8"; 15/16"; 1"; 1-1/16"; 1-1/8"; 1-3/16"; 1-1/4"		
<b>4243S-9</b>			
Part no.	Socket	4/22.0/23.0/0.9'	5500g
Changed Items 549 5.16...1.1.4	Content: 1/2"DR. 18-12pt. Flank socket 5/16"; 3/8"; 7/16"; 1/2"; 9/16"; 19/32"; 5/8"; 11/16"; 3/4"; 25/32"; 13/16"; 7/8"; 15/16"; 1"; 1-1/16"; 1-1/8"; 1-3/16"; 1-1/4"		





<b>24pc Socket set (MM)</b>			
<b>4245</b>			
Part no.	Socket	4/20.7/21.7/0.9'	5175g
545 10...32	Content: 1/2"DR. 18-6pt. Flank socket 10; 11; 12; 13; 14; 15; 16; 17; 18; 19; 20; 21; 22; 23; 24; 27; 30; 32 mm		
80244	1-Ratchet handle		
8034250	1-Sliding T handle		
8044 125...250	2-Extension bar 5" ; 10"		
80541	1-Universal joint		
8154410A	1-Speed handle		
<b>4245-7</b>			
Part no.	Socket	4/20.7/21.7/0.9'	5175g
Changed Items 547 10...32	Content: 1/2"DR. 18-Surface drive socket 10; 11; 12; 13; 14; 15; 16; 17; 18; 19; 20; 21; 22; 23; 24; 27; 30; 32 mm		
<b>4245-9</b>			
Part no.	Socket	4/20.7/21.7/0.9'	5175g
Changed Items 549 10...32	Content: 1/2"DR. 18-12pt. Flank socket 10; 11; 12; 13; 14; 15; 16; 17; 18; 19; 20; 21; 22; 23; 24; 27; 30; 32 mm		

**24pc Socket set (SAE)**



<b>4245S</b>			
Part no.	Socket	4/20.7/21.7/0.9'	5175g
Changed Items	Content: 1/2"DR.		
545 5.16...1.1.4	18-6pt. Flank socket 5/16"; 3/8"; 7/16"; 1/2"; 9/16"; 19/32"; 5/8"; 11/16"; 3/4"; 25/32"; 13/16"; 7/8"; 15/16"; 1"; 1-1/16"; 1/8"; 1-3/16"; 1-1/4"		



<b>4245S-7</b>			
Part no.	Socket	4/20.7/21.7/0.9'	5175g
Changed Items	Content: 1/2"DR.		
547 5.16...1.1.4	18-Surface drive socket 5/16"; 3/8"; 7/16"; 1/2"; 9/16"; 19/32"; 5/8"; 11/16"; 3/4"; 25/32"; 13/16"; 7/8"; 15/16"; 1"; 1-1/16"; 1/8"; 1-3/16"; 1-1/4"		



<b>4245S-9</b>			
Part no.	Socket	4/20.7/21.7/0.9'	5175g
Changed Items	Content: 1/2"DR.		
549 5.16...1.1.4	18-12pt. Flank socket 5/16"; 3/8"; 7/16"; 1/2"; 9/16"; 19/32"; 5/8"; 11/16"; 3/4"; 25/32"; 13/16"; 7/8"; 15/16"; 1"; 1-1/16"; 1/8"; 1-3/16"; 1-1/4"		









**24pc Socket set (MM)**



<b>4245B</b>			
Part no.	Socket	4/20.7/21.7/0.9'	5175g
545 10...32	Content: 1/2"DR. 18-6pt. Flank socket 10; 11; 12; 13; 14; 15; 16; 17; 18; 19; 20; 21; 22; 23; 24; 27; 30; 32 mm		
80244	1-Ratchet handle		
8034250	1-Sliding T handle		
8044 125...250	2-Extension bar 5" ; 10"		
80541	1-Universal joint		
8014380	1-Swivel handle 15"		







<b>4245B-7</b>			
Part no.	Socket	4/20.7/21.7/0.9'	5175g
Changed Items	Content: 1/2"DR.		
547 10...32	18-Surface drive socket 10; 11; 12; 13; 14; 15; 16; 17; 18; 19; 20; 21; 22; 23; 24; 27; 30; 32 mm		







<b>4245B-9</b>			
Part no.	Socket	4/20.7/21.7/0.9'	5175g
Changed Items	Content: 1/2"DR.		
549 10...32	18-12pt. Flank socket 10; 11; 12; 13; 14; 15; 16; 17; 18; 19; 20; 21; 22; 23; 24; 27; 30; 32 mm		

24pc Socket set (SAE)			
<b>4245BS</b>			
Part no.	Socket	4/20.7/21.7/0.9'	5175g
Changed Items 545 5.16...1.1.4	Content: 1/2"DR. 18-6pt. Flank socket 5/16"; 3/8"; 7/16"; 1/2"; 9/16"; 19/32"; 5/8"; 11/16"; 3/4"; 25/32"; 13/16"; 7/8"; 15/16"; 1"; 1-1/16"; 1-1/8"; 1-3/16"; 1-1/4"		
<b>4245BS-7</b>			
Part no.	Socket	4/20.7/21.7/0.9'	5175g
Changed Items 547 5.16...1.1.4	Content: 1/2"DR. 18-Surface drive socket 5/16"; 3/8"; 7/16"; 1/2"; 9/16"; 19/32"; 5/8"; 11/16"; 3/4"; 25/32"; 13/16"; 7/8"; 15/16"; 1"; 1-1/16"; 1-1/8"; 1-3/16"; 1-1/4"		









24pc Socket set (MM)			
<b>4246</b>			
Part no.	Socket	4/20.6/21.6/0.9'	5150g
547 10...32	Content: 1/2"DR. 18-Surface drive socket 10; 11; 12; 13; 14; 15; 16; 17; 18; 19; 20; 21; 22; 23; 24; 27; 30; 32 mm		
80243	1-Ratchet handle		
8034250	1-Sliding T handle		
8044 125...250	2-Extension bar 5" ; 10"		
80541	1-Universal joint		
807420.6	1-Spark plug socket 20.6mm		

<b>4246-5</b>			
Part no.	Socket	4/20.7/21.7/0.9'	5175g
Changed Items 545 10...32	Content: 1/2"DR. 18-6pt. Flank socket 10; 11; 12; 13; 14; 15; 16; 17; 18; 19; 20; 21; 22; 23; 24; 27; 30; 32 mm		
<b>4246-9</b>			
Part no.	Socket	4/20.7/21.7/0.9'	5175g
Changed Items 549 10...32	Content: 1/2"DR. 18-12pt. Flank socket 10; 11; 12; 13; 14; 15; 16; 17; 18; 19; 20; 21; 22; 23; 24; 27; 30; 32 mm		

24pc Socket set (SAE)			
<b>4246S</b>			
Part no.	Socket	4/20.6/21.6/0.9'	5150g
Changed Items 547 5.16...1.1.4	Content: 1/2"DR. 18-Surface drive socket 5/16"; 3/8"; 7/16"; 1/2"; 9/16"; 19/32"; 5/8"; 11/16"; 3/4"; 25/32"; 13/16"; 7/8"; 15/16"; 1"; 1-1/16"; 1-1/8"; 1-3/16"; 1-1/4"		
<b>4246S-5</b>			
Part no.	Socket	4/20.7/21.7/0.9'	5175g
Changed Items 545 5.16...1.1.4	Content: 1/2"DR. 18-6pt. Flank socket 5/16"; 3/8"; 7/16"; 1/2"; 9/16"; 19/32"; 5/8"; 11/16"; 3/4"; 25/32"; 13/16"; 7/8"; 15/16"; 1"; 1-1/16"; 1-1/8"; 1-3/16"; 1-1/4"		



25pc Star set			
4252			
Part no.	Bit	15/18.0/19.0/1'	1200g
	Content: 1/2"DR.		
32632 08...30	7-1/4"DR. Star socket bit (32mmL) T8; T10; T15; T20; T25; T27; T30		
346055 40...60	7-1/2"DR. Star socket bit (55mmL) T40; T45; T50; T55; T60		
	10-Star socket		
526 04...08	1/4"DR.: E4; E5; E6; E7; E8		
546 10...18	1/2"DR.: E10; E11; E12; E14; E18		
766 06...10	3-Star key T6; T8; T10		



26pc Socket set			
4262			
Part no.	Bit	4/22.4/23.4/0.9'	5600g
	Content: 1/2"DR.		
545 10...32	18-6pt. Flank socket 10; 11; 12; 13; 14; 15; 16; 17; 18; 19; 20; 21; 22; 23; 24; 27; 30; 32 mm		
80244	1-Ratchet handle		
8014380	1-Swivel handle		
8044 075...250	3-Extension bar 3"; 5"; 10"		
80541	1-Universal joint		
8154410A	1-Speed handle		

4262-7			
Part no.	Bit	4/22.4/23.4/0.9'	5600g
Changed Items	Content: 1/2"DR.		
547 10...32	18-Surface drive socket 10; 11; 12; 13; 14; 15; 16; 17; 18; 19; 20; 21; 22; 23; 24; 27; 30; 32 mm		



4262-9			
Part no.	Bit	4/22.4/23.4/0.9'	5600g
Changed Items	Content: 1/2"DR.		
549 10...32	18-12pt. Flank socket 10; 11; 12; 13; 14; 15; 16; 17; 18; 19; 20; 21; 22; 23; 24; 27; 30; 32 mm		



**27pc Socket set**

<b>4281</b>		
Part no.	6/21.0/22.0/0.9'	3500g
	Content: 3/8" & 1/2"DR.	
	11-1/2"DR. Hex socket bit	
344055 04...12	4; 5; 6; 7; 8; 10; 12 mm (55mmL)	
34406014	14mm (60mmL)	
34407017	17mm (70mmL)	
34408008	8mm (80mmL)	
34414010	10mm (140mmL)	
	10-1/2"DR. Spline socket bit	
348055 05...16	M5; M6; M8; M10; M12; M14; M16 (55mmL)	
348110 10...12	M10; M12 (110mmL)	
34812005	M8 (120mmL)	
33450 04...10	6-3/8"DR. Hex socket bit	
	4; 5; 6; 7; 8; 10 mm (50mmL)	

**28pc 10mm Bit set**

<b>4283</b>		
Part no.	15/18.0/19.0/1'	1200g
	Content: 3/8" & 1/2"DR.	
	11-10mm Hex bit	
17430 04...12	4; 5; 6; 7; 8; 10; 12 mm (30mmL)	
17475 05...10	5; 6; 8; 10 mm (75mmL)	
	8-10mm Spline bit	
17830 05...10	M5; M6; M8; M10 (30mmL)	
17875 06...12	M6; M8; M10; M12 (75mmL)	
17630 20...55	7-10mm Star bit (30mmL)	
	T20; T25; T30; T40; T45; T50; T55	
810 37...47	2-Bit holder	
	3/8"DR.x10mm; 1/2"DR.x10mm	





**28pc Combination set**

<b>4291</b>			
Part no.	Socket	4/19.7/20.7/0.9'	4925g
549 10...32	Content: 1/2"DR. 12-12pt. Flank socket 10; 11; 12; 13; 14; 15; 17; 19; 22; 24; 30; 32 mm		
54977 12...17	3-12pt. Flank deep socket 12; 13; 17 mm (77mmL)		
346055 20...50	6-Star socket bit (55mmL) T20; T25; T30; T40; T45; T50		
8074 16...20.6	2-Spark plug socket 16; 20.6mm		
80242	1-Ratchet handle		
8044 125...250	2-Extension bar 5"; 10"		
80541	1-Universal joint		
80634	1-Adaptor for extension 3/8"(F)x1/2"(M)		

<b>4291-5</b>			
Part no.	Socket	4/19.7/20.7/0.9'	4925g
Changed Items	Content: 1/2"DR.		
545 10...32	12-6pt. Flank socket 10; 11; 12; 13; 14; 15; 17; 19; 22; 24; 30; 32 mm		
54577 12...17	3-6pt. Flank deep socket 12; 13; 17 mm (77mmL)		

<b>4291-7</b>			
Part no.	Socket	4/19.7/20.7/0.9'	4925g
Changed Items	Content: 1/2"DR.		
547 10...32	12-Surface drive socket 10; 11; 12; 13; 14; 15; 17; 19; 22; 24; 30; 32 mm		
54777 12...17	3-Surface drive deep socket 12; 13; 17 mm (77mmL)		





**32pc Socket set**

<b>4321</b>			
Part no.	Socket	4/22.2/23.2/0.9'	5550g
545 08...32	Content: 1/2"DR. 20-6pt. Flank socket 8; 9; 10; 11; 12; 13; 14; 15; 16; 17; 18; 19; 20; 21; 22; 23; 24; 26; 27; 32 mm		
545 3.8...11.16	4-6pt. Flank socket 3/8"; 1/2"; 9/16"; 11/16"		
802411	1-Ratchet handle		
8014380	1-Swivel handle 15"		
8044 075...250	3-Extension bar 3"; 5"; 10"		
8074 16...20.6	2-Spark plug socket 16; 20.6 mm		
80541	1-Universal joint		



<b>4321-7</b>			
Part no.	Socket	4/22.2/23.2/0.9'	5550g
Changed Items	Content: 1/2"DR.		
547 08...32	20-Surface drive socket 8; 9; 10; 11; 12; 13; 14; 15; 16; 17; 18; 19; 20; 21; 22; 23; 24; 26; 27; 32 mm		
547 3.8...11.16	4-Surface drive socket 3/8"; 1/2"; 9/16"; 11/16"		



**35pc Bit set**



<b>4351</b>		
Part no.		
	10/22.5/23.5/0.7'	2500g
	Content: 3/8" & 1/2"DR.	
	14-10mm Hex bit	
17430 04...12	4; 5; 6; 7; 8; 10; 12 (30mmL)	
17475 04...10	4; 5; 6; 7; 8; 10; 12 (75mmL)	
	14-10mm Star bit	
17630 20...55	T20; T25; T30; T40; T45; T50; T55 (30mmL)	
17675 20...55	T20; T25; T30; T40; T45; T50; T55 (75mmL)	
	4-14mm Star bit	
19650 60...70	T60; T70 (50mmL)	
19675 60...70	T60; T70 (75mmL)	
810 37...414	3-Bit holder 3/8"DR.x10mm; 1/2"DR.x10mm; 1/2"DR.x14mm	

**35pc Star set**



<b>4352</b>			
Part no.			
	Bit	15/21.3/22.3/1'	1420g
	Content: 1/4" & 3/8" & 1/2"DR.		
1263009	1-1/4" Star bit T9 (30mmL)		
12730 10...20	3-1/4" Star tamperproof bit T-10H; T-15H; T-20H (30mmL)		
17675 25...55	7-10mm Star bit (75mmL) T25; T27; T30; T40; T45; T50; T55		
17730 25...50	6-10mm Star tamperproof bit T-25H; T-27H; T-30H; T-40H; T-45H; T-50H (30mmL)		
19675 60...70	2-14mm Star bit T60; T70 (75mmL)		
526 04...08	3-1/4"DR. Star socket E4; E5; E6; E7; E8		
536 10...20	7-3/8"DR. Star socket E10; E11; E12; E14; E16; E18; E20		
810 22...414	4-Bit holder 1/4"DR.x1/4"; 3/8"DR.x10mm; 1/2"DR.x10mm; 1/2"DR.x14mm		









**40pc Bit set**

<b>4401</b>		
Part no.	10/20.0/21.0/0.7'	2000g
	Content: 3/8" & 1/2"DR.	
	14-10mm Hex bit	
17430 04...12	4; 5; 6; 7; 8; 10; 12 mm (30mmL)	
17475 04...12	4; 5; 6; 7; 8; 10; 12 mm (75mmL)	
	14-10mm Star bit	
17630 20...55	T20; T25; T30; T40; T45; T50; T55 (30mmL)	
17675 20...55	T20; T25; T30; T40; T45; T50; T55 (75mmL)	
	10-10mm Spline bit	
17830 05...12	M5; M6; M8; M10; M12 (30mmL)	
17875 05...12	M5; M6; M8; M10; M12 (75mmL)	
810 37...47	2-Bit holder 3/8"DR.x10mm; 1/2"DR.x10mm	

**40pc Bit set**



<b>4401C</b>		
Part no.	10/19.0/20.0/1'	1900g
	Content: 1/2"DR.	
	14-10mm Hex bit	
17430 04...12	4; 5; 6; 7; 8; 10; 12 mm (30mmL)	
17475 04...12	4; 5; 6; 7; 8; 10; 12 mm (75mmL)	
	14-10mm Star bit	
17630 20...55	T20; T25; T30; T40; T45; T50; T55 (30mmL)	
17675 20...55	T20; T25; T30; T40; T45; T50; T55 (75mmL)	
	10-10mm Spline bit	
17830 05...12	M5; M6; M8; M10; M12 (30mmL)	
17875 05...12	M5; M6; M8; M10; M12 (75mmL)	
810 37...47	2-Bit holder 3/8"DR.x10mm; 1/2"DR.x10mm	

<b>4401T</b>			
Part no.	Bit	10/20.0/21.0/0.7'	2000g
Changed Items	Content: 3/8" & 1/2"DR.		
	14-10mm Star bit		
17730 20...55	T-20H; T-25H; T-30H; T-40H; T-45H; T-50H; T-55H (30mmL)		
17775 20...55	T-20H; T-25H; T-30H; T-40H; T-45H; T-50H; T-55H (75mmL)		

<b>4401CT</b>			
Part no.	Bit	10/19.0/20.0/1'	1900g
Changed Items	Content: 1/2"DR.		
	14-10mm Star tamperproof bit		
17730 20...55	T-20H; T-25H; T-30H; T-40H; T-45H; T-50H; T-55H (30mmL)		
17775 20...55	T-20H; T-25H; T-30H; T-40H; T-45H; T-50H; T-55H (75mmL)		





**40pc Combination set**

<b>4403</b>			
Part no.	Socket	4/22.1/23.1/0.9'	5530g
	Content: 3/8" & 1/2"DR.		
545 08...32	19-6pt. Flank socket 8; 10; 11; 12; 13; 14; 15; 16; 17; 18; 19; 20; 21; 22; 23; 24; 27; 30; 32 mm		
54577 12...17	4-6pt. Flank deep socket 12; 13; 15; 17 mm		
344055 06...12	9-Socket bit (55mmL) Hex 6; 8; 10; 12 mm		
346055 30...55	Star T30; T40; T45; T50; T55		
80249	1-72 teeth ratchet handle		
8044 125...250	1-Extension bar 5"; 10"		
80541	1-Universal joint		
80634	1-Adaptor for extension 3/8"(F)x1/2"(M)		
8074 16...20.6	3-Spark plug socket 16mm; 18mm; 20.6mm		









**41pc Star set**

<b>4411</b>			
Part no.	Bit	6/14.8/15.8/0.9'	2466g
	Content: 1/4" & 3/8" & 1/2"DR.		
766 09...70	13-Star L key T9; T10; T15; T20; T25; T27; T30; T40; T45; T50; T55; T60; T70		
12630 09...20	4-1/4" Star bit (30mmL) T9; T10; T15; T20		
17630 25...50	6-10mm Star bit (30mmL) T25; T27; T30; T40; T45; T50		
17611555	1-10mm Star bit T55 (115mmL)		
19675 60...70	2-14mm Star bit (75mmL) T60; T70		
526 04...08	5-1/4"DR. Star socket E4; E5; E6; E7; E8		
536 10...20	7-3/8"DR. Star socket E10; E11; E12; E14; E16; E18; E20		
810 22...414	3-Bit holder 1/4"DR.x1/4"; 3/8"DR.x10mm; 1/2"DR.x14mm		







**41pc Socket set**

<b>4412</b>			
Part no.	Socket	4/26.6/27.6/0.9'	6650g
	Content: 1/2"DR. 33-12pt. Flank Socket		
549 10...32	10; 11; 12; 13; 14; 15; 16; 17; 18; 19; 20; 21; 22; 23; 24; 27; 30; 32 mm		
549 3.8...1.1.4	3/8"; 7/16"; 1/2"; 9/16"; 5/8"; 11/16"; 3/4"; 13/16"; 7/8"; 15/16"; 1"; 1-1/16"; 1-1/8"; 1-3/16"; 1-1/4"		
80242	1-Ratchet handle		
8044 125...250	2-Extension bar 5"; 10"		
8074 16...20.6	2-Spark plug socket 16; 20.6 mm		
8034250	1-Sliding T handle		
80541	1-Universal joint		
8154410	1-Speed handle		

<b>4412-5</b>			
Part no.	Socket	4/26.6/27.6/0.9'	6650g
Changed Items	Content: 1/2"DR. 33-6pt. Flank socket		
545 10...32	10; 11; 12; 13; 14; 15; 16; 17; 18; 19; 20; 21; 22; 23; 24; 27; 30; 32 mm		
545 3.8...1.1.4	3/8"; 7/16"; 1/2"; 9/16"; 5/8"; 11/16"; 3/4"; 13/16"; 7/8"; 15/16"; 1"; 1-1/16"; 1-1/8"; 1-3/16"; 1-1/4"		

**42pc Bit set**



<b>4421</b>			
Part no.		10/21.0/22.0/0.7'	2100g
	Content: 3/8" & 1/2"DR. 14-10mm Hex bit		
17430 04...12	4; 5; 6; 7; 8; 10; 12 mm (30mmL)		
17475 04...12	4; 5; 6; 7; 8; 10; 12 mm (75mmL)		
	16-10mm Star bit		
17630 20...60	T20; T25; T30; T40; T45; T50; T55; T60 (30mmL)		
17675 20...60	T20; T25; T30; T40; T45; T50; T55; T60 (75mmL)		
	10-10mm Spline bit		
17830 05...12	M5; M6; M8; M10; M12 (30mmL)		
17875 05...12	M5; M6; M8; M10; M12 (75mmL)		
810 37...47	2-Bit holder 3/8"DR.x10mm; 1/2"DR.x10mm		



<b>4421T</b>			
Part no.	Socket	4/26.6/27.6/0.9'	2100g
Changed Items	Content: 3/8" & 1/2"DR. 16-10mm Star tamperproof bit		
17730 20...60	T-20H; T-25H; T-30H; T-40H; T-45H; T-50H; T-55H; T-60H (30mmL)		
17775 20...60	T-20H; T-25H; T-30H; T-40H; T-45H; T-50H; T-55H; T-60H (75mmL)		







**42pc Bit set**

<b>4421C</b>		
Part no.	10/20.0/21.0/1'	2000g
	Content: 3/8" & 1/2"DR.	
17430 04...12	14-10mm Hex bit 4; 5; 6; 7; 8; 10; 12 mm (30mmL)	
17475 04...12	4; 5; 6; 7; 8; 10; 12 mm (75mmL)	
17630 20...60	16-10mm Star bit T20; T25; T30; T40; T45; T50; T55; T60 (30mmL)	
17675 20...60	T20; T25; T30; T40; T45; T50; T55; T60 (75mmL)	
17830 05...12	10-10mm Spline bit M5; M6; M8; M10; M12 (30mmL)	
17875 05...12	M5; M6; M8; M10; M12 (75mmL)	
810 37...47	2-Bit holder 3/8"DR.x10mm; 1/2"DR.x10mm	

<b>4421CT</b>			
Part no.	Bit	10/20.0/21.0/1'	2000g
Changed Items	Content: 3/8" & 1/2"DR.		
17730 20...60	16-10mm Star tamperproof bit T-20H; T-25H; T-30H; T-40H; T-45H; T-50H; T-55H; T-60H (30mmL)		
17775 20...60	T-20H; T-25H; T-30H; T-40H; T-45H; T-50H; T-55H; T-60H (75mmL)		





**42pc 1/2" Spline socket set**



<b>4422Q</b>			
Part no.	Socket	4/19.5/20.5/0.9'	4875g
	Content: 1/2"DR.		
54Q 10...32	17-Spline socket 10; 11; 12; 13; 14; 15; 16; 17; 18; 19; 20; 21; 22; 24; 27; 30; 32 mm		
80242	1-Ratchet handle		
80541	1-Universal Joint		
80634	1-Adaptor for Extension		
8044 125...250	2-Extension bar 125-5"; 250-10"		
81047	1-Bit holder		
17830 05...12	5-Spline bit M5; M6; M8; M10; M12		
17430 05...12	6-Hex bit H5; H6; H7; H8; H10; H12		
17630 20...55	8-Torx bit T20; T25; T27; T30; T40; T45; T50; T55		









**44pc Bit set**

<b>4441C</b>		
Part no.		
	10/22.5/23.5/1'	2250g
	Content: 3/8" & 1/2"DR.	
	14-10mm Hex bit	
17430 04...12	4; 5; 6; 7; 8; 10; 12 mm (30mmL)	
17475 04...12	4; 5; 6; 7; 8; 10; 12 mm (75mmL)	
	16-10mm Star bit	
17630 20...60	T20; T25; T30; T40; T45; T50; T55; T60 (30mmL)	
17675 20...60	T20; T25; T30; T40; T45; T50; T55; T60 (75mmL)	
	10-10mm Spline bit	
17830 05...12	M5; M6; M8; M10; M12 (30mmL)	
17875 05...12	M5; M6; M8; M10; M12 (75mmL)	
34610070	1-Star socket bit T70 (100mmL)	
34607080	1-Star socket bit T80 (70mmL)	
810 37...47	2-Bit holder 3/8"DR.x10mm; 1/2"DR.x10mm	

**44pc Bit set**



<b>4442C</b>		
Part no.		
	10/22.0/23.0/1'	2200g
	Content: 3/8" & 1/2"DR.	
	14-10mm Hex bit	
17430 04...12	4; 5; 6; 7; 8; 10; 12 mm (30mmL)	
17475 04...12	4; 5; 6; 7; 8; 10; 12 mm (75mmL)	
	16-10mm Star bit	
17630 20...60	T20; T25; T30; T40; T45; T50; T55; T60 (30mmL)	
17675 20...60	T20; T25; T30; T40; T45; T50; T55; T60 (75mmL)	
	10-10mm Spline bit	
17830 05...12	M5; M6; M8; M10; M12 (30mmL)	
17875 05...12	M5; M6; M8; M10; M12 (75mmL)	
34610070	1-Star socket bit T70 (100mmL)	
34614055	1-Star socket bit T55 (140mmL)	
810 37...47	2-Bit holder 3/8"DR.x10mm; 1/2"DR.x10mm	



<b>4441CT</b>			
Part no.			
	Bit	10/22.5/23.5/1'	2250g
Changed Items	Content: 3/8" & 1/2"DR.		
	16-10mm Star tamperproof bit		
17730 20...60	T-20H; T-25H; T-30H; T-40H; T-45H; T-50H; T-55H; T-60H (30mmL)		
17775 20...60	T-20H; T-25H; T-30H; T-40H; T-45H; T-50H; T-55H; T-60H (75mmL)		
34710070	1-Star tamperproof socket bit T-70H (100mmL)		
34707080	1-Star tamperproof socket bit T-80H (70mmL)		



<b>4442CT</b>			
Part no.			
	Bit	10/22.0/23.0/1'	2200g
Changed Items	Content: 3/8" & 1/2"DR.		
	16-10mm Star tamperproof bit		
17730 20...60	T-20H; T-25H; T-30H; T-40H; T-45H; T-50H; T-55H; T-60H (30mmL)		
17775 20...60	T-20H; T-25H; T-30H; T-40H; T-45H; T-50H; T-55H; T-60H (75mmL)		



**51pc Combination set**



<b>4511</b>			
Part no.	Socket	3/17.3/18.3/1'	5760g
	Content: 1/4" & 1/2"DR.		
	1/4"DR. Part:		
529 04...13	11-12pt. Flank socket 4; 4.5; 5; 6; 7; 8; 9; 10; 11; 12; 13 mm		
	10-Socket bit (32mmL)		
32432 03...06	Hex 3; 4; 5; 6 mm		
32332 04...07	Slotted 4; 5.5; 7 mm		
32132 1...3	Phillips PH.1; PH.2; PH.3		
80222	1-Ratchet handle		
8042 050...100	2-Extension bar 2"; 4"		
8032115	1-Sliding T handle		
80521	1-Universal joint		
8143	1-Spinner		
	1/2"DR. Part:		
549 10...30	12-12pt. Flank socket 10; 11; 12; 13; 14; 15; 17; 19; 22; 24; 27; 30 mm		
	5-Hex socket bit		
344055 07...12	7; 8; 10; 12 mm (55mmL)		
34406514	14 mm (65mmL)		
343055 08...10	2-Slotted socket bit 1.2x8; 1.6x10 mm (55mmL)		
341554	1-Phillips socket bit PH.4 (55mmL)		
80242	1-Ratchet handle		
8044125	2-Extension bar 5"		
808410	Locking extension 10"		
80541	1-Universal joint		



<b>4511-5</b>			
Part no.	Socket	3/17.3/18.3/1'	5760g
Changed Items	Content: 1/4" & 1/2"DR.		
	1/4"DR. Part:		
525 04...13	11-6pt. Flank socket 4; 4.5; 5; 6; 7; 8; 9; 10; 11; 12; 13 mm		
	1/2"DR. Part:		
545 10...30	12-6pt. Flank socket 10; 11; 12; 13; 14; 15; 17; 19; 22; 24; 27; 30 mm		



<b>4511-7</b>			
Part no.	Socket	3/17.3/18.3/1'	5760g
Changed Items	Content: 1/4" & 1/2"DR.		
	1/4"DR. Part:		
527 04...13	11-Surface drive socket 4; 4.5; 5; 6; 7; 8; 9; 10; 11; 12; 13 mm		
	1/2"DR. Part:		
547 10...30	12-Surface drive socket 10; 11; 12; 13; 14; 15; 17; 19; 22; 24; 27; 30 mm		





**51pc Combination set**



<b>4512</b>			
Part no.	Socket	3/16.8/17.8/1'	5600g
547 10...32	Content: 1/2"DR. 15-Surface drive socket 10; 11; 12; 13; 14; 15; 16; 17; 18; 19; 22; 24; 27; 30; 32 mm		
80242	1-Ratchet handle		
8044 125...250	2-Extension bar 5"; 10"		
8074 16...20.6	2-Spark plug socket 16; 20.6 mm		
80541	1-Universal joint		
80634	1-Adaptor for extension 3/8"(F)x1/2"(M)		
755 08...22	9-Combination wrench 8; 10; 11; 12; 13; 14; 17; 19; 22 mm		
5102A	10pc Hex key set		
764 0127...10	1.27; 1.5; 2; 2.5; 3; 4; 5; 6; 8; 10 mm		
5102XLBA	10pc Hex extra long ball key set		
765 0127XL...10XL	1.27; 1.5; 2; 2.5; 3; 4; 5; 6; 8; 10 mm		

<b>4512-5</b>			
Part no.	Socket	3/16.8/17.8/1'	5600g
Changed Items	Content: 1/2"DR.		
545 10...32	15-6pt. Flank socket 10; 11; 12; 13; 14; 15; 16; 17; 18; 19; 22; 24; 27; 30; 32 mm		



<b>4512-9</b>			
Part no.	Socket	3/16.8/17.8/1'	5600g
Changed Items	Content: 1/2"DR.		
549 10...32	15-12pt. Flank socket 10; 11; 12; 13; 14; 15; 16; 17; 18; 19; 22; 24; 27; 30; 32 mm		

**53pc Combination set**



<b>4541</b>			
Part no.	Socket	4/20.0/21.0/0.9'	5000g
529 04...11	Content: 1/4" & 1/2"DR. 1/4"DR. Part: 9-12pt. Flank socket 4; 5; 5.5; 6; 7; 8; 9; 10; 11 mm 16-Socket bit (32mmL) Hex 3; 4; 5; 6 mm Star T10; T20; T25; T27; T30; T40 Slotted 4; 5.5; 7 mm PH.1; PH.2; PH.3		
80222	1-Ratchet handle		
8042 050...150	2-Extension bar 2"; 6"		
80521	1-Universal joint		
8142	1-Spinner		
764-4	4-Hex key 1.27; 1.5; 2; 2.5 mm		
549 10...32	1/2"DR. Part: 12-12pt. Flank socket 10; 11; 12; 13; 14; 15; 17; 20; 22; 24; 30; 32 mm		
80242	1-Ratchet handle		
8044 125...250	2-Extension bar 5"; 10"		
8074 16...20.6	2-Spark plug socket 16 ; 20.6mm		
80541	1-Universal joint		
80634	1-Adaptor for extension 3/8"(F)x1/2"(M)		



<b>4541-5</b>			
Part no.	Socket	4/20.0/21.0/0.9'	5000g
Changed Items	Content: 1/4" & 1/2"DR.		
525 04...11	1/4"DR. Part: 9-6pt. Flank socket 4; 5; 5.5; 6; 7; 8; 9; 10; 11 mm		
545 10...32	1/2"DR. Part: 12-6pt. Flank socket 10; 11; 12; 13; 14; 15; 17; 20; 22; 24; 30; 32 mm		





<b>4541-7</b>			
Part no.	Socket	4/20.0/21.0/0.9'	5000g
Changed Items	Content: 1/4" & 1/2"DR. 1/4"DR. Part: 9-Surface drive socket 4; 5; 5.5; 6; 7; 8; 9; 10; 11 mm 1/2"DR. Part: 12-Surface drive socket 10; 11; 12; 13; 14; 15; 17; 20; 22; 24; 30; 32 mm		
527 04...11			
547 10...32			



<b>4601-5</b>			
Part no.	Socket	3/17.0/18.0/1'	5660g
545 10...32	Content: 1/2"DR. 17-6pt. Flank socket 10; 11; 12; 13; 14; 15; 16; 17; 18; 19; 20; 21; 22; 24; 27; 30; 32 mm		
54577 10...22	9-6pt. Flank deep socket (77mmL) 10; 11; 12; 13; 14; 15; 17; 19; 22 mm		

<b>4601-9</b>			
Part no.	Socket	3/17.0/18.0/1'	5660g
54910...32	Content: 1/2"DR. 17-12pt. Flank socket 10; 11; 12; 13; 14; 15; 16; 17; 18; 19; 20; 21; 22; 24; 27; 30; 32 mm		
54977 10...22	9-12pt. Flank deep socket (77mmL) 10; 11; 12; 13; 14; 15; 17; 19; 22 mm		



**60pc Combination set**



<b>4601</b>			
Part no.	Socket	3/17.0/18.0/1'	5660g
547 10...32	Content: 1/2"DR. 17-Surface driver socket 10; 11; 12; 13; 14; 15; 16; 17; 18; 19; 20; 21; 22; 24; 27; 30; 32 mm		
54777 10...22	9-Surface driver deep socket (77mmL) 10; 11; 12; 13; 14; 15; 17; 19; 22 mm 26-5/16" bit (30mmL)		
15430 04...14	Hex 4; 5; 6; 8; 10; 12; 14 mm		
15630 20...55	Star T20; T25; T27; T30; T40; T45; T50; T55		
15330 08...12	Slotted 8; 10; 12 mm		
15130 1...4	Phillips PH.1; PH.2; PH.3; PH.4		
15230 1...4	Pozidriv PZ.1; PZ.2; PZ.3; PZ.4		
80242	1-Ratchet handle		
8074 16...20.6	2-Spark plug socket 16; 20.6 mm		
8044 125...250	2-Extension bar 5"; 10"		
80541	1-Universal joint		
81045	1-Bit holder 1/2"DR.x5/16"		
80634	1-Adaptor for extension 3/8"(F)x1/2"(M)		











**60pc Combination set**

<b>4611</b>			
Part no.	Socket	3/20.3/21.3/1'	6760g
	Content: 1/4" & 1/2"DR.		
	1/4"DR. Part:		
529 04...10	8-12pt. Flank Socket 4; 5; 5.5; 6; 7; 8; 9; 10 mm		
52950 08...10	2-12pt. Flank deep socket 8; 10 mm (50mmL)		
	11-Socket bit (32mmL)		
32432 04...06	Hex 4; 5; 6 mm		
32632 10...30	Star T10; T20; T25; T30		
32132 1...2	Phillips PH.1; PH.2		
32332 04...055	Slotted 4; 5.5 mm		
80222	1-Ratchet handle		
8042 050...150	2-Extension bar 2"; 6"		
80521	1-Universal joint		
8142	1-Spinner		
764-4	4-Hex key 1.27; 1.5; 2; 2.5 mm		
	1/2"DR. Part:		
549 10...32	12-12pt. Flank Socket 10; 11; 12; 13; 14; 15; 17; 19; 22; 24; 30; 32 mm		
54977 12...17	3-12pt. Flank deep socket 12; 13; 17 mm (77mmL)		
344100 07...10	3-Hex socket bit 7; 8; 10 mm (100mmL)		

<b>4611</b>			
Part no.	Socket	3/20.3/21.3/1'	6760g
346055 40...50	3-Star socket bit T40; T45; T50		
341553	1-Phillips socket bit PH.3		
34305508	1-Slotted socket bit 8 mm		
80242	1-Ratchet handle		
8074 16...20.6	2-Spark plug socket 16; 20.6mm		
8044125	1-Extension bar 5"		
808410	1-Locking extension 10"		
8034250	1-Sliding T handle		
80541	1-Universal joint		

<b>4611-5</b>			
Part no.	Socket	3/20.3/21.3/1'	6760g
Changed Items	Content: 1/4" & 1/2"DR.		
	1/4"DR. Part:		
525 04...10	8-6pt. Flank Socket 4; 5; 5.5; 6; 7; 8; 9; 10 mm		
52550 08...10	2-6pt. Flank deep socket 8; 10 mm (50mmL)		
	1/2"DR. Part:		
545 10...32	12-6pt. Flank Socket 10; 11; 12; 13; 14; 15; 17; 19; 22; 24; 30; 32 mm		
54577 12...17	3-6pt. Flank deep socket 12; 13; 17 mm (77mmL)		

<b>4611-7</b>			
Part no.	Socket	3/20.3/21.3/1'	6760g
Changed Items	Content: 1/4" & 1/2"DR.		
	1/4"DR. Part:		
527 04...10	8-Surface drive Socket 4; 5; 5.5; 6; 7; 8; 9; 10 mm		
52750 08...10	2-Surface drive deep socket 8; 10 mm (50mmL)		
	1/2"DR. Part:		
547 10...32	12-Surface drive Socket 10; 11; 12; 13; 14; 15; 17; 19; 22; 24; 30; 32 mm		
54777 12...17	3-Surface drive deep socket 12; 13; 17 mm (77mmL)		



**60pc Combination set**

**4611-72**



Part no.	Socket	3/20.3/21.3/1'	6760g
	Content: 1/4" & 1/2"DR. 1/4"DR. Part:		
529 04...10	8-12pt. Flank Socket	4; 5; 5.5; 6; 7; 8; 9; 10 mm	
52950 08...10	2-12pt. Flank deep socket	8; 10 mm (50mmL)	
	11-Socket bit (32mmL)		
32432 04...06	Hex 4; 5; 6 mm		
32632 10...30	Star T10; T20; T25; T30		
32132 1...2	Phillips PH.1; PH.2		
32332 04...055	Slotted 4; 5.5 mm		
80229	1-72 teeth ratchet handle		
8042 050...150	2-Extension bar 2"; 6"		
80521	1-Universal joint		
8142	1-Spinner		
764-4	4-Hex key 1.27; 1.5; 2; 2.5 mm		
	1/2"DR. Part:		
549 10...32	12-12pt. Flank Socket	10; 11; 12; 13; 14; 15; 17; 19; 22; 24; 30; 32 mm	
54977 12...17	3-12pt. Flank deep socket	12; 13; 17 mm (77mmL)	
344100 07...10	3-Hex socket bit	7; 8; 10 mm (100mmL)	
346055 40...50	3-Star socket bit T40; T45; T50		
341553	1-Phillips socket bit PH.3		
34305508	1-Slotted socket bit 8 mm		
80249	1-72 teeth ratchet handle		
8074 16...20.6	2-Spark plug socket 16; 20.6 mm		
8044125	1-Extension bar 5"		
808410	1-Locking extension 10"		
8034250	1-Sliding T handle		
80541	1-Universal joint		



**64pc Socket set**



**4641**





Part no.	Socket	2/22.0/23.0/0.77'	11kg
	Content: 3/8" & 1/2" DR. 3/8"DR. Part:		
535 13...19	7-6pt. Flank socket (MM)	13; 14; 15; 16; 17; 18; 19 mm	
535 3.8...11.16	4-6pt. Flank socket (SAE)	3/8"; 1/2"; 9/16"; 11/16"	
53563 08...19	11-6pt. Flank deep socket (MM)	8; 10; 11; 12; 13; 14; 15; 16; 17; 18; 19 mm	
53563 3.8...11.16	4-6pt. Flank deep socket (SAE)	3/8"; 1/2"; 9/16"; 11/16"	
8073 16...20.6	3-Spark plug socket	16; 18; 20.6 mm (10; 12; 14 mm)	
802311	1-Ratchet handle		
8043 045...250	2-Extension bar 3"; 10"		
80643	1-Adaptor for extension	1/2"(F) to 3/8"(M)	
8033165	1-Sliding T handle		
80531	1-Universal joint		
	1/2"DR. Part:		
545 20...32	11-6pt. Flank socket (MM)	20; 21; 22; 23; 24; 25; 26; 27; 28; 30; 32 mm	
545 13.16...1.1.8	3-6pt. Flank deep socket (SAE)	13/16"; 1"; 1-1/8"	
548W 3.16...3.4	9-12pt. WW socket	3/16"; 1/4"; 5/16"; 3/8"; 7/16"; 1/2"; 9/16"; 5/8"; 3/4"	
802411	1-Ratchet handle		
8044 125...250	2-Extension bar 5"; 10"		
8014380	1-Swivel handle 15"		
8154410A	1-Speed handle		
80541	1-Universal joint		



**64pc Star set**



<b>4651</b>			
Part no.	Bit	3/20.3/21.3/1'	6766g
Content: 1/4" & 3/8" & 1/2" DR.			
11-Star socket			
526 04...10	1/4": E4; E5; E6; E8; E10		
546 10...24	1/2": E10; E12; E14; E18; E20; E24		
11-Impact star socket			
426 04...10	1/4": E4; E5; E6; E8; E10		
446 10...24	1/2": E10; E12; E14; E18; E20; E24		
5-Star socket bit			
	T40; T45; T50; T55; T60 (55mmL)		
5-Impact star socket bit (one-piece)			
246 30...60	T30; T40; T50; T55; T60 (40mmL)		
7-Star screwdriver			
716 06...30	T6; T8; T10; T15; T20; T25; T30		
11-Star key			
766 08...60	T8; T10; T15; T20; T25; T27; T30; T45; T50; T55; T60		
4-Star wrench			
756 0608...2024	E6xE8; E10xE12; E14xE18; E20xE24		
7-1/4" Star bit (25mmL)			
12625 08...30	T8; T9; T10; T15; T20; T25; T30		
3-5/16" Star bit (35mmL)			
15635 40...50	T40; T45; T50		







**65pc Socket set**

<b>4652</b>		
Part no.	2/28.5/29.5/0.77'	14.2kg
Content: 1/4" & 1/2" & 3/4" DR.		
1/4"DR. Part:		
12-6pt. Flank socket		
525 04...12	4; 5.5; 6; 7; 8; 9; 10; 11; 12 mm	
525 3.16...3.8	3/16"; 1/4"; 3/8"	
80222	1-Ratchet handle	
8012140	1-1/4" Swivel handle	
8032115	1-Sliding T handle	
8143	1-Spinner handle	
8042 050...150	2-Extension bar 50; 150 mm	
80521	1-Universal joint	
8032115A	1-Cross bar 115 mm	
1/2"DR. Part:		
26-6pt. Flank socket		
545 08...32	8; 9; 10; 11; 12; 13; 14; 15; 16; 17; 19; 20; 21; 22; 23; 24; 26; 27; 29; 30; 32 mm	
545 3.8...1	3/8"; 1/2"; 9/16"; 11/16"; 1"	
80242	1-Ratchet handle	
8014380	1-Swivel handle 15"	
8034250	1-Sliding T handle	
8044 075...250	3-Extension bar 75; 125; 250 mm	
80541	1-Universal joint	
8034150A	1-Cross bar 150mmL	
3/4"DR. Part:		
9-12pt. Flank socket		
569 26...41	26; 27; 29; 30; 32; 35; 36; 38; 41 mm	
8026500	1-Ratchet handle 500 mmL	
8046200	1-Extension bar 200 mmL	



**68pc Combination set**

<b>4682</b>			
Part no.	Socket	5/24.0/25.0/1.4'	4800g
	Content: 1/4" & 1/2"DR.		
	1/4"DR. Part:		
527 04...14	13-Surface drive socket 4; 4.5; 5; 5.5; 6; 7; 8; 9; 10; 11; 12; 13; 14 mm		
	22-Socket bit (32mmL)		
32332 04...07	Slotted 4; 5.5; 7 mm		
32432 03...08	Hex 3; 4; 5; 6; 7; 8 mm		
32132 1...3	Phillips PH.1; PH.2; PH.3		
32232 1...3	Pozidriv PZ.1; PZ.2; PZ.3		
32632 08...30	Star T8; T10; T15; T20; T25; T27; T30		
80222	1-Ratchet handle		
8042 050...100	2-Extension bar 2"; 4"		
8032115	1-Sliding T handle		
8111	1-Flexible extension		
80521	1-Universal joint		
8143	1-Spinner		
764-4	4-Hex key 1.27; 1.5; 2; 2.5 mm		
	1/2"DR. Part:		
547 10...32	15-Surface drive socket 10; 11; 12; 13; 14; 15; 16; 17; 18; 19; 22; 24; 27; 30; 32 mm		
80242	1-Ratchet handle		
8044 125...250	2-Extension bar 5"; 10"		
8074 16...20.6	2-Spark plug socket 16; 20.6 mm		
80541	1-Universal joint		
80634	1-Adaptor for extension 3/8"(F)x1/2"(M)		

<b>4682-5</b>			
Part no.	Socket	5/24.0/25.0/1.4'	4800g
	Content: 1/4" & 1/2"DR.		
	1/4"DR. Part:		
525 04...14	13-6pt. Flank socket 4; 4.5; 5; 5.5; 6; 7; 8; 9; 10; 11; 12; 13; 14 mm		
	1/2"DR. Part:		
545 10...32	15-6pt. Flank socket 10; 11; 12; 13; 14; 15; 16; 17; 18; 19; 22; 24; 27; 30; 32 mm		
<b>4682-9</b>			
Part no.	Socket	5/24.0/25.0/1.4'	4800g
	Content: 1/4" & 1/2"DR.		
	1/4"DR. Part:		
529 04...14	13-12pt. Flank socket 4; 4.5; 5; 5.5; 6; 7; 8; 9; 10; 11; 12; 13; 14 mm		
	1/2"DR. Part:		
549 10...32	15-12pt. Flank socket 10; 11; 12; 13; 14; 15; 16; 17; 18; 19; 22; 24; 27; 30; 32 mm		





**68pc Combination set**

<b>4683</b>			
Part no.	Socket	3/17.6/18.6/1'	5850g

	Content: 1/4" & 1/2"DR.		
	1/4"DR. Part:		
525 04...13	12-6pt. Flank socket	4; 4.5; 5; 5.5; 6; 7; 8; 9; 10; 11; 12; 13 mm	
	20-Socket bit (32mmL)		
32132 1...2	Phillips PH.1; PH.2		
32232 1...2	Pozidriv PZ.1; PZ.2		
32332 04...065	Slotted 4; 5.5; 6.5 mm		
32432 03...08	Hex 3; 4; 5; 6; 8 mm		
32632 08...40	Star T8; T10; T15; T20; T25; T27; T30; T40		
80229	1-72 teeth ratchet handle		
8032115	1-Sliding T handle		
8042 050...100	2-Extension bar 2"; 4"		
80521	1-Universal joint		
8143	1-Spinner 6"		
764-4	4-Hex key 1.27; 1.5; 2; 2.5 mm		
	1/2"DR. Part:		
545 10...32	18-6pt. Flank socket	10; 11; 12; 13; 14; 15; 16; 17; 18; 19; 20; 21; 22; 23; 24; 27; 30; 32 mm	
80249	1-72 teeth ratchet handle		
8044 075...250	3-Extension bar 3"; 5"; 10"		
80541	1-Universal joint		
80634	1-Adaptor for extension	3/8"(F)x1/2"(M)	
8074 16...20.6	2-Spark plug socket 16; 20.6mm		

**73pc Star set**

<b>4731</b>			
Part no.	Bit	3/13.5/14.5/1'	4500g

	Content: 1/4" & 1/2"DR.		
766 08...70	13-Star key	T8; T10; T15; T20; T25; T27; T30; T40; T45; T50; T55; T60; T70	
756 0608...2024	4-Star wrench	E6xE8; E10xE12; E14xE18; E20xE24	
546 12...24	7-1/2"DR. Star socket	E12; E14; E16; E18; E20; E22; E24	
526 04...11	7-1/4"DR. Star socket	E4; E5; E6; E7; E8; E10; E11	
346055 30...60	6-1/2"DR. Star socket bit (55mmL)	T30; T40; T45; T50; T55; T60	
32632 08...27	6-1/4"DR. Star socket bit (32mmL)	T8; T10; T15; T20; T25; T27	
17730 10...55	10-10mm Star tamperproof bit	T-10H; T-15H; T-20H; T-25H; T-27H; T-30H; T-40H; T-45H; T-50H; T-55H (30mmL)	
17675 10...55	10-10mm Star bit	T10; T15; T20; T25; T27; T30; T40; T45; T50; T55 (75mmL)	
81047	1-Bit holder 1/2"DR.x10mm		
717 06B...40B	9-Star tamperproof screwdriver	T6H; T8H; T10H; T15H; T20H; T25H; T27H; T30H; T40H	







**76pc Combination set**



<b>4761</b>			
Part no.	Socket	3/20.7/21.7/1.7'	6900g
	Content: 1/4" & 1/2"DR.		
	1/4"DR. Part:		
527 04...14	13-Surface driver socket 4; 4.5; 5; 5.5; 6; 7; 8; 9; 10; 11; 12; 13; 14 mm		
80222	1-Ratchet handle		
8042 050...100	2-Extension bar 2"; 4"		
8032115	1-Sliding T handle		
80521	1-Universal joint		
8143	1-Spinner		
764-3	3-Hex key 1.5; 2; 2.5 mm		
	1/2"DR. Part:		
547 08...32	18-Surface drive socket 8; 10; 11; 12; 13; 14; 15; 16; 17; 18; 19; 20; 21; 22; 24; 27; 30; 32 mm		
80242	1-Ratchet handle		
8074 16...20.6	2-Spark plug socket 16; 20.6mm		
8044 125...250	2-Extension bar 5"; 10"		
80541	1-Universal joint		
80634	1-Adaptor for extension 3/8"DR.x1/2"(M)		
755 08...22	9-Combination wrench 8; 10; 11; 12; 13; 14; 17; 19; 22 mm		
5102A	10pc Hex short key set		
764 0127...10	1.27; 1.5; 2; 2.5; 3; 4; 5; 6; 8; 10 mm		
5102XLBA	10pc Hex extra long ball key set		
765 0127XL...10XL	1.27; 1.5; 2; 2.5; 3; 4; 5; 6; 8; 10 mm		

<b>4761-5</b>			
Part no.	Socket	3/20.7/21.7/1.7'	6900g
Changed Items	Content: 1/4" & 1/2"DR.		
	1/4"DR. Part:		
525 04...14	13-6pt. Flank socket 4; 4.5; 5; 5.5; 6; 7; 8; 9; 10; 11; 12; 13; 14 mm		
	1/2"DR. Part:		
545 08...32	18-6pt. Flank socket 8; 10; 11; 12; 13; 14; 15; 16; 17; 18; 19; 20; 21; 22; 24; 27; 30; 32 mm		
<b>4761-9</b>			
Part no.	Socket	3/20.7/21.7/1.7'	6900g
Changed Items	Content: 1/4" & 1/2"DR.		
	1/4"DR. Part:		
529 04...14	13-12pt. Flank socket 4; 4.5; 5; 5.5; 6; 7; 8; 9; 10; 11; 12; 13; 14 mm		
	1/2"DR. Part:		
549 08...32	18-12pt. Flank socket 8; 10; 11; 12; 13; 14; 15; 16; 17; 18; 19; 20; 21; 22; 24; 27; 30; 32 mm		





4771			
Part no.	Socket	3/22.1/23.1/1.7'	7380g
68601	1-LED white light, clip-type (360" rotation)		
755 08...19	9-Combination wrench 8; 10; 11; 12; 13; 14; 15; 17; 19 mm		
611B160	1-Combination pliers		
610B160	1-Long nose pliers		
613B250	1-Waterpump pliers		
5055P4	1-Utility Knife (incl. 2pc blades)		
2125P1	1-Induction circuit tester		
5102LB	10pc Hex ball point long key set 1.27; 1.5; 2; 2.5; 3; 4; 5; 6; 8; 10 mm		



**77pc Combination Set**



4771			
Part no.	Socket	3/22.1/23.1/1.7'	7380g
	Content: 1/4" & 1/2"DR.		
	1/4"DR. Part:		
525 04...12	11-6pt. Flank socket 4; 4.5; 5; 5.5; 6; 7; 8; 9; 10; 11; 12 mm		
81022	1-Bit holder		
81225	1-Magnetic socket pick-up		
8143	1-Spinner		
8042 050...100	2-Extension bar 2" & 4"		
80521	1-Universal joint		
802223	1-72 teeth flexible ratchet		
21111	11pc bit set Phillips PH.0; PH.1; PH.2; PH.3 Pozidriv PZ.0; PZ.1; PZ.2; PZ.3 Slotted 5.5; 6.5 mm Magnetic quick-release bit holder		
	1/2"DR. Part:		
545 10...24	12-6pt. Flank socket 10; 11; 12; 13; 14; 15; 16; 17; 18; 19; 22; 24 mm		
80242	1-24 teeth Ratchet		
80541	1-Universal joint		
8044 125...250	2-Extension bar 5" & 10"		
80634	1-Adaptor for Extension 3/8"(F) x 1/2"(M)		
8074 16...20.6	2-Spark plug socket 16 & 20.6mm		
	Others :		
66302	1-Mini hacksaw		
5055P3	2pc Saw blade		
616300	1-Engineer hammer 300g		





**82pc Combination set**

<b>4821</b>			
Part no.	Socket	3/18.0/19.0/1'	6000g
	Content: 1/4" & 1/2"DR.		
	1/4"DR. Part:		
527 04...14	13-Surface driver socket 4; 4.5; 5; 5.5; 6; 7; 8; 9; 10; 11; 12; 13; 14 mm		
	17-Socket bit (32mmL)		
32432 03...06	Hex 3; 4; 5; 6 mm		
32632 08...30	Star T8; T10; T15; T20; T25; T30		
32332 04...07	Slotted 4; 5.5; 7 mm		
32132 1...2	Phillips PH.1; PH.2		
32232 1...2	Pozidriv PZ.1; PZ.2		
80222	1-Ratchet handle		
8032115	1-Sliding T handle		
8042 050...100	2-Extension bar 2"; 4"		
80521	1-Universal joint		
8111	1-Flexible extension		
8143	1-Spinner		
8092225	1-Bit adaptor 25mmL		
	1/2"DR. Part:		
547 14...32	12-Surface driver socket 14; 15; 16; 17; 18; 19; 20; 22; 24; 27; 30; 32 mm		
	15-5/16" bit (30mmL)		
15430 08...14	Hex 8; 10; 12; 14 mm		
15630 40...55	Star T40; T45; T50; T55		
15330 08...12	Slotted 8; 10; 12 mm		

<b>4821</b>			
Part no.	Socket	3/18.0/19.0/1'	6000g
15130 3...4	Phillips PH.3; PH.4		
15230 3...4	Pozidriv PZ.3; PZ.4		
80243	1-Ratchet handle		
80541	1-Universal joint		
8044 125...250	2-Extension bar 5"; 10"		
8074 16...20.6	2-Spark plug socket 16; 20.6 mm		
81045	1-Bit holder 1/2"DR.x5/16"		
80634	1-Adaptor for extension 3/8"(F)x1/2"(M)		
755 08...22	9-Combination wrench 8; 10; 11; 12; 13; 14; 17; 19; 22 mm		

<b>4821-5</b>			
Part no.	Socket	3/18.0/19.0/1'	6000g
	Content: 1/4" & 1/2"DR.		
	1/4"DR. Part:		
525 04...14	13-6pt. Flank socket 4; 4.5; 5; 5.5; 6; 7; 8; 9; 10; 11; 12; 13; 14 mm		
	1/2"DR. Part:		
545 14...32	12-6pt. Flank socket 14; 15; 16; 17; 18; 19; 20; 22; 24; 27; 30; 32 mm		



<b>4821-9</b>			
Part no.	Socket	3/18.0/19.0/1'	6000g
	Content: 1/4" & 1/2"DR.		
	1/4"DR. Part:		
529 04...14	13-12pt. Flank socket 4; 4.5; 5; 5.5; 6; 7; 8; 9; 10; 11; 12; 13; 14 mm		
	1/2"DR. Part:		
549 14...32	12-12pt. Flank socket 14; 15; 16; 17; 18; 19; 20; 22; 24; 27; 30; 32 mm		





**91pc Combination Set**

**4911**   

Part no.	Socket	2/20.0/21.0/1.54'	10000g
	Content: 1/4" & 1/2"DR. 1/4"DR. Part: 24-1/4"Bit (30mmL)		
12130 0...3		Phillips PH.0; PH.1; PH.2; PH.3	
12230 1...3		Pozidriv PZ.1; PZ.2; PZ.3	
12330 055...07		Slotted 5.5; 7 mm	
12430 02...10		Hex 2; 3; 4; 5; 6; 7; 8; 10 mm	
12730 10...40		Star tamperproof T-10H; T15H; T-20H; T-25H; T-27H; T-30H; T-40H	
525 04...13	12-6pt. Flank socket	4; 4.5; 5; 5.5; 6; 7; 8; 9; 10; 11; 12; 13 mm	
80222	1-24 teeth ratchet		
8032115	1-Sliding T handle		
8042 050...100	2-Extension bar 2"; 4"		
80521	1-Universal joint		
81022	1-Bit holder		
8111	1-Flexible extension		
81225	1-Magnetic socket pick-up		
8143	1-Spinner		
545 08...21	1/2"DR. Part: 12-6pt. Flank socket	8; 10; 12; 13; 14; 15; 16; 17; 18;	
54577 22...32	5-6pt. Flank deep socket	19; 20; 21 mm 22; 24; 27; 30; 32 mm	

Part no.	Socket	2/20.0/21.0/1.54'	10000g
<b>4911</b>			
8014380		1-Swivel handle (380mmL)	
80243		1-24 teeth Ratchet - thin	
8044 050W....125W		2-Wobble extension 2"; 5"	
8044250		1-Extension bar 10"	
80541		1-Universal joint	
80634		1-Adaptor for Extension 3/8"(F) x 1/2"(M)	
8074 16...20.6		2-Spark plug socket 16 & 20.6 mm	
		Others:	
755 06...22		10-Combination wrench 6; 8; 10; 12; 13; 14; 15; 17; 19; 22 mm	
616300		1-Engineering hammer 300gw	
610B200		1-Long nose pliers 8"	
611B175		1-Combination pliers 7"	
613B250		1-Waterpump pliers 10"	
6046210		1-Pin punch 6 (210mmL)	
60215180		1-Chisel 15 (180mmL)	
7111BS		1-Stubby phillips screwdriver PH.1	
7112B		1-Phillips screwdriver PH.2	
713055BS		1-Stubby slotted screwdriver 5.5mm x25mmL	
713065B		1-Slotted screwdriver 6.5mm x 150mmL	

Part no.	Socket	2/20.0/21.0/1.54'	10000g
<b>4911-9</b>			
Changed Items	Content: 1/4" & 1/2"DR. 1/4"DR. Part:		
529 04...13	12-12pt. Flank socket	4; 4.5; 5; 5.5; 6; 7; 8; 9; 10; 11; 12; 13 mm	
549 08...21	1/2"DR. Part: 12-12pt. Flank socket	8; 10; 12; 13; 14; 15; 16; 17; 18; 19; 20; 21 mm	
54977 22...32	5-12pt. Flank deep socket	22; 24; 27; 30; 32 mm	





**91pc Combination Set**

**4921**



Part no. Bit 2/11.7/12.7/0.77' 5850g

Part no.	Bit	2/11.7/12.7/0.77'	5850g
<b>Content: 1/4" &amp; 1/2"DR.</b>			
756	6-Offset star wrench	E6xE8; E7xE11; E10xE12; E14xE18; E16xE22;E20xE24	
0608A...2024A			
766 06...55	14-Star key	T6; T7; T8; T9; T10; T15; T20; T25; T27; T30; T40;T45; T50; T55	
71606B	1-Star screwdriver T6		
717 07B...40B	10-Star tamperproof screwdriver	T-7H; T-8H; T-9H; T-10H; T-15H; T-20H; T-25H;T-27H; T-30H; T-40H;	
	14-Star socket	1/4": E4; E5; E6; E7; E8; E10; E11 1/2": E12; E14; E16; E18; E20; E22; E24	
526 04...11	4-1/2" Star socket bit	T55 (140mmL)	
546 12...24		T60 (55mmL)	
34614055		T70 (100mmL)	
34605560		T80 (70mmL)	
34610070	3-1/4" Star bit	T6; T7 (25mmL)	
34607080		T25 (65mmL)	
12625 06...07	10-1/4" Star tamperproof bit (25mmL)	T-8H; T-9H; T-10H; T-15H; T-20H; T-25H; T-27H;T-30H; T-35H; T-40H	
1266525	8-10mm Star bit	T47 (30mmL)	
12725 08...40		T40; T45; T50 (75mmL)	
1763047		T-40H; T45H; T-50H; T-55H (30mmL)	
17675 40...50	2-Bit holder	1/4"DR.x1/4"(F); 1/2"DR.x10mm	
17730 40...55			
810 22...47	20-Plastic star gauge		
5201			



**94pc Combination set**



**4941**









Part no. Socket 3/21.0/22.0/1' 7000g

Part no.	Socket	3/21.0/22.0/1'	7000g
<b>Content: 1/4" &amp; 1/2"DR.</b>			
<b>1/4"DR. Part:</b>			
527 04...14	13-Surface driver socket	4; 4.5; 5; 5.5; 6; 7; 8; 9; 10; 11; 12; 13; 14 mm	
52750 06...13	8-Surface driver deep socket	6; 7; 8; 9; 10; 11; 12; 13; (50mmL)	
32432 03...06	18-Socket bit (32mmL)	Hex 3; 4; 5; 6 mm	
32632 08...30		Star T8; T10; T15; T20; T25; T27; T30	
32332 04...065		Slotted 4; 5.5; 6.5 mm	
32132 1...2		Phillips PH.1; PH.2	
32232 1...2		Pozidriv PZ.1; PZ.2	
80222	1-Ratchet handle		
8042 050...100	2-Extension bar 2"; 4"		
8032115	1-Sliding T handle		
80521	1-Universal joint		
8143	1-Spinner		
764-3	3-Hex key 1.5; 2; 2.5 mm		
<b>1/2"DR. Part:</b>			
547 10...32	17-Surface drive socket	10; 11; 12; 13; 14; 15; 16; 17; 18; 19; 20; 21; 22; 24;27; 30; 32 mm	
54777 14...22	5-Surface drive deep socket	14; 15; 17; 19; 22; (77mmL)	
	16-5/16" bit (30mmL)	Hex 7; 8; 10; 12; 14 mm	
15430 07...14		Star T40; T45; T50; T55	
15630 40...55			





<b>4941</b>			
Part no.	Socket	3/21.0/22.0/1'	7000g
15330 08...12	Slotted 8; 10; 12 mm		
15130 3...4	Phillips PH.3; PH.4		
15230 3...4	Pozidriv PZ.3; PZ.4		
80242	1-Ratchet handle		
8074 16...20.6	2-Spark plug socket 16; 20.6mm		
8044 125...250	2-Extension bar 5"; 10"		
80541	1-Universal joint		
81045	1-Bit holder 1/2"DR.x5/16"		
80634	1-Adaptor for extension 3/8"DR.x1/2"(M)		



<b>4941-5</b>			
Part no.	Socket	3/21.0/22.0/1'	7000g
Changed Items	Content: 1/4" & 1/2"DR.		
	1/4"DR. Part:		
525 04...14	13-6pt. Flank socket 4; 4.5; 5; 5.5; 6; 7; 8; 9; 10; 11; 12; 13; 14 mm		
52550 06...13	8-6pt. Flank deep socket 6; 7; 8; 9; 10; 11; 12; 13; (50mmL)		
	1/2"DR. Part:		
545 10...32	17-6pt. Flank socket 10; 11; 12; 13; 14; 15; 16; 17; 18; 19; 20; 21; 22; 24;27; 30; 32 mm		
54577 14...22	5-6pt. Flank deep socket 14; 15; 17; 19; 22; (77mmL)		



<b>4941-9</b>			
Part no.	Socket	3/21.0/22.0/1'	7000g
Changed Items	Content: 1/4" & 1/2"DR.		
	1/4"DR. Part:		
529 04...14	13-12pt. Flank socket 4; 4.5; 5; 5.5; 6; 7; 8; 9; 10; 11; 12; 13; 14 mm		
52950 06...13	8-12pt. Flank deep socket 6; 7; 8; 9; 10; 11; 12; 13; (50mmL)		
	1/2"DR. Part:		
549 10...32	17-12pt. Flank socket 10; 11; 12; 13; 14; 15; 16; 17; 18; 19; 20; 21; 22; 24;27; 30; 32 mm		
54977 14...22	5-12pt. Flank deep socket 14; 15; 17; 19; 22; (77mmL)		



**102pc Combination Set**



<b>41021</b>			
Part no.	Socket	2/19.5/20.5/1.54'	9750g
	Content: 1/4" & 1/2"DR.		
	1/4"DR. Part:		
12725 06...40	11-Star tamperproof bit T-6H; T- 7H; T- 8H; T- 9H; T- 10H; T-15H; T-20H; T-25H; T-27H; T-30H; T-40H		
12425 02...10	10-Hex bit 2; 2.5; 3; 4; 5;5.5; 6; 7; 8; 10 mm		
525 04...10	9-6pt Flank socket 4; 4.5; 5; 5.5; 6; 7; 8; 9; 10 mm		
526 04...10	6-Star socket E4; E5; E6; E7; E8; E10		
80222	1-24 teeth ratchet handle		
8032115	1-Sliding T handle 115mmL		
8042 100...150	2-Extension bar 4"(100mmL); 6"(150mmL)		
8111	1-Flexible extension 145mmL		
8143	1-Spinner 6"(150mmL)		
80521	1-Universal joint		
81022	1-Bit holder 1/4"(F)x1/4"(F)		
	1/2"DR. Part:		
545 08...32	20-6pt. Flank socket 8; 9; 10; 11; 12; 13; 14; 15; 16; 17;18; 19; 20; 21; 22; 23; 24; 27; 30; 32 mm		
546 10...18	5-Star socket E10; E12; E14; E16; E18		



<b>41021</b>			
Part no.	Socket	2/19.5/20.5/1.54'	9750g
8034250	1-Sliding T handle 10"(250mmL)		
80243	1-24 teeth Thin ratchet handle		
8044250	1-Extension bar 10"(250mmL)		
8044050W	1-Wobble extension		
8074 16...20.6	2-Spark plug socket 16; 20.6 mm		
80541	1-Universal joint		
8044125	1-Extension bar 5"(125mmL)		
<b>Others:</b>			
617	1-Multi-function magnetic pick-up		
711 1M...2M	2-Hammer phillips screwdriver PH.1; PH.2		
713 055M... 065M	2-Hammer slotted screwdriver 5.5; 6.5 mm		
751 0810...1719	4-Flare nut wrench 8x10; 11x13; 12x14; 17x19 mm		
755 08...24	14-Combination wrench 8; 10; 11; 12; 13; 14; 15; 16; 17; 18; 19; 21; 22; 24 mm		
611B175	1-Combination pliers		
649200A	1-Adjustable gauged wrench 8" (200mmL)		

<b>41021-9</b>			
Part no.	Socket	2/19.5/20.5/1.54'	9750g
<b>Changed Items</b>	<b>Content: 1/4" &amp; 1/2"DR.</b>		
	<b>1/4"DR. Part:</b>		
529 04...10	9-12pt. Flank socket 4; 4.5; 5; 5.5; 6; 7; 8; 9; 10 mm		
	<b>1/2"DR. Part:</b>		
549 08...32	20-12pt. Flank socket 8; 9; 10; 11; 12; 13; 14; 15; 16; 17;18; 19; 20; 21; 22; 23; 24; 27; 30; 32 mm		





**107pc Combination Set**



<b>41071</b>			
Part no.	Socket	2/22.4/23.4/1.54'	11.2kg
<b>Content: 1/4" &amp; 1/2"DR.</b>			
<b>1/4"DR. Part:</b>			
24-1/4"Bit (30mmL)			
12130 0...3	Phillips PH.0; PH.1; PH.2; PH.3		
12230 1...3	Pozi driv PZ.1; PZ.2; PZ.3		
12330 055...07	Slotted 5.5; 7 mm		
12430 02...10	Hex 2; 3; 4; 5; 6; 7; 8; 10 mm		
12730 10...40	Star tamperproof T-10H; T15H; T-20H; T-25H;T-27H; T-30H; T-40H		
525 04...13	12-6pt. Flank socket 4; 4.5; 5; 5.5; 6; 7; 8; 9; 10; 11; 12; 13 mm		
80222	1-24 teeth Ratchet		
8032115	1-Sliding T handle		
8042 050...100	2-Extension bar 2"; 4"		
80521	1-Universal joint		
81022	1-Bit holder		
8111	1-Flexible extension		
81225	1-Magnetic socket pick-up		
8143	1-Spinner		
<b>1/2"DR. Part:</b>			
545 08...21	12-6pt. Flank socket 8; 10; 12; 13; 14; 15; 16; 17; 18; 19; 20; 21 mm		
54577 22...32	5-6pt. Flank deep socket 22; 24; 27; 30; 32 mm		
8014380	1-Swivel handle (380mmL)		
80243	1-24 teeth thin ratchet		
8044 050W... 125W	2-Wobble extension 2"; 5"		

<b>41071</b>			
Part no.	Socket	2/22.4/23.4/1.54'	11.2kg
8044250	1-Extension bar 10"		
80541	1-Universal joint		
80634	1-Adaptor for Extension 3/8"(F) x 1/2"(M)		
8074 16...20.6	2-Spark plug socket 16 ; 20.6 mm		
755 06...22	Others: 16-Combination wrench 6; 7; 8; 9; 10; 11; 12; 13; 14; 15; 16; 17; 18; 19;21; 22 mm		
751 0810...1719	5-Flare nut wrench 8x10; 10x12; 11x13; 12x14; 17x19 mm		
764 025...14	10-Hex key 2.5; 3; 4; 5; 6; 7; 8; 10; 12; 14 mm		
616300	1-Engineering hammer 300gw		
611B175	1-Combination pliers 7"		
613B250	1-Waterpump pliers 10"		
60215180	1-Chisel 15 (180mmL)		
618	1-20 blade Feeler gauge		





**108pc Combination set**



<b>41081</b>			
Part no.	Socket	3/21.0/22.0/1.7'	7000g
<b>Content: 1/4" &amp; 1/2"DR.</b>			
<b>1/4"DR. Part:</b>			
527 04...14	13-Surface driver socket 4; 4.5; 5; 5.5; 6; 7; 8; 9; 10; 11; 12; 13; 14 mm		
52750 07...10	3-Surface drive deep socket 7; 8; 10 mm (50mmL)		
18-Socket bit (32mmL)			
32432 03...06	Hex 3; 4; 5; 6 mm		
32632 08...30	Star T8; T10; T15; T20; T25; T27; T30		
32332 04...065	Slotted 4; 5.5; 6.5 mm		
32132 1...2	Phillips PH.1; PH.2		
32232 1...2	1-Pozidriv PZ.1; PZ.2		
80222	2-Ratchet handle		
8042 050...100	1-Extension bar 2"; 4"		
8032115	1-Sliding T handle		
80521	1-Universal joint		
8143	1-Spinner		
764-3	3-Hex key 1.5; 2; 2.5 mm		
<b>1/2"DR. Part:</b>			
547 08...32	18-Surface drive socket 8; 10; 11; 12; 13; 14; 15; 16; 17; 18; 19; 20; 21; 22; 24; 27; 30; 32 mm		
54777 12...17	3-Surface drive deep socket 12; 13; 17 (77mmL)		

<b>41071-9</b>			
Part no.	Socket	2/22.4/23.4/1.54'	11.2kg
<b>Changed Items</b>			
Content: 1/4" & 1/2"DR.			
<b>1/4"DR. Part:</b>			
529 04...13	12-12pt. Flank socket 4; 4.5; 5; 5.5; 6; 7; 8; 9; 10; 11; 12; 13 mm		
<b>1/2"DR. Part:</b>			
549 08...21	12-12pt. Flank socket 8; 10; 12; 13; 14; 15; 16; 17; 18; 19; 20; 21 mm		
54977 22...32	5-12pt. Flank deep socket 22; 24; 27; 30; 32 mm		









<b>41081</b>			
Part no.	Socket	3/21.0/22.0/1.7'	7000g
	16-5/16" bit (30mmL)		
15430 07...14	Hex 7; 8; 10; 12; 14 mm		
15630 40...55	Star T40; T45; T50; T55		
15330 08...12	Slotted 8; 10; 12 mm		
15130 3...4	Phillips PH.3; PH.4		
15230 3...4	Pozidriv PZ.3; PZ.4		
80242	1- Ratchet handle		
8074 16...20.6	2- Spark plug socket 16; 20.6mm		
8044 125...250	2- Extension bar 5"; 10"		
80541	1- Universal joint		
80634	1- Adaptor for extension 3/8"(F).x1/2"(M)		
81045	1- Bit holder 1/2"DR.x5/16"		
5102A	10pc Hex short key set		
764 0127...10	1.27; 1.5; 2; 2.5; 3; 4; 5; 6; 8; 10 mm		
5102XLBA	10pc Hex extra long ball key set		
765 0127...10 XL	1.27; 1.5; 2; 2.5; 3; 4; 5; 6; 8; 10 mm		





<b>41081-5</b>			
Part no.	Socket	3/21.0/22.0/1.7'	7000g
Changed Items	Content: 1/4" & 1/2"DR.		
	1/4"DR. Part:		
525 04...14	13-6pt. Flank socket 4; 4.5; 5; 5.5; 6; 7; 8; 9; 10; 11; 12; 13; 14 mm		
52550 07...10	3-6pt. Flank deep socket 7; 8; 10 mm (50mmL)		
	1/2"DR. Part:		
545 08...32	18-6pt. Flank socket 8; 10; 11; 12; 13; 14; 15; 16; 17; 18; 19; 20; 21; 22; 24; 27; 30; 32 mm		
54577 12...17	3-6pt. Flank deep socket 12; 13; 17 (77mmL)		

**108pc Combination set**



<b>41082</b>			
Part no.	Socket	3/22.8/23.8/1.7'	7600g
	Content: 1/4" & 1/2"DR.		
	1/4"DR. Part:		
527 04...14	13-Surface driver socket 4; 4.5; 5; 5.5; 6; 7; 8; 9; 10; 11; 12; 13; 14 mm		
52750 06...13	8- Surface driver deep socket 6; 7; 8; 9; 10; 11; 12; 13 (50mmL)		
526 04...08	5- 1/4" Torx socket E4; E5; E6; E7; E8		
	18-Socket bit (32mmL)		
32432 03...06	Hex 3; 4; 5; 6		
32632 08...30	Star T8; T10; T15; T20; T25; T27; T30		
32332 04...065	Slotted 4; 5.5; 6.5		
32132 1...2	Phillips PH.1; PH.2		
32232 1...2	Pozidriv PZ.1; PZ.2		
80222	1- Ratchet handle		
8042 050...100	2- Extension bar 2"; 4"		
8032115	1- Sliding T handle		
80521	1- Universal joint		
8143	1- Spinner		
764-3	3- Hex key 1.5; 2; 2.5		
	1/2"DR. Part:		
547 10...32	17-Surface drive socket 10; 11; 12; 13; 14; 15; 16; 17; 18; 19; 20; 21; 22; 24; 27; 30; 32 mm		
54777 14...22	5- Surface drive deep socket 14; 15; 17; 19; 22 (77mmL)		



<b>41081-9</b>			
Part no.	Socket	3/21.0/22.0/1.7'	7000g
Changed Items	Content: 1/4" & 1/2"DR.		
	1/4"DR. Part:		
529 04...14	13-12pt. Flank socket 4; 4.5; 5; 5.5; 6; 7; 8; 9; 10; 11; 12; 13; 14 mm		
52950 07...10	3-12pt. Flank deep socket 7; 8; 10 mm (50mmL)		
	1/2"DR. Part:		
549 08...32	18-12pt. Flank socket 8; 10; 11; 12; 13; 14; 15; 16; 17; 18; 19; 20; 21; 22; 24; 27; 30; 32 mm		
54977 12...17	3-12pt. Flank deep socket 12; 13; 17 (77mmL)		

<b>41082</b>			
Part no.	Socket	3/22.8/23.8/1.7'	7600g
546 10...24	8- 1/2" Torx socket E10; E11; E12; E14; E16; E18; E20; E24		
15430 07...14	17-5/16" bit (30mmL) Hex 7; 8; 10; 12; 14		
15630 40...60	Star T40; T45; T50; T55; T60		
15330 08...12	Slotted 8; 10; 12		
15130 3...4	Phillips PH.3; PH.4		
15230 3...4	Poqidriv PZ.3; PZ.4		
80242	1- Ratchet handle		
8074 16...20.6	2- Spark plug socket 16mm; 20.6mm		
8044125W	1- Wobble extension 5"		
8044250	1- Extension bar 10"		
80541	1- Universal joint		
81045	1- Bit holder 1/2"DR.x5/16"		
80634	1- Adaptor for extension 3/8"DR.x1/2"(M)		









**142pc Combination Set**









<b>41082-9</b>			
Part no.	Socket	3/22.8/23.8/1.7'	7600g
Changed Items	Content: 1/4" & 1/2"DR.		
529 04...14	1/4"DR. Part: 13-12pt. Flank socket 4; 4.5; 5; 5.5; 6; 7; 8; 9; 10; 11; 12; 13; 14 mm		
52950 06...13	8-12pt. Flank deep socket 6; 7; 8; 9; 10; 11; 12; 13 (50mmL)		
549 10...32	1/2"DR. Part: 17-12pt. Flank socket 10; 11; 12; 13; 14; 15; 16; 17; 18; 19; 20; 21; 22; 24; 27; 30; 32 mm		
54977 14...22	5-12pt. Flank deep socket 14; 15; 17; 19; 22 (77mmL)		

<b>41421</b>			
Part no.	Socket	2/26.0/27.0/1.54'	13kg
Content: 1/4" & 3/8" & 1/2"DR.			
1/4"DR. Part:			
26-1/4" bit (30mmL)			
12130 0...3	Phillips PH.0; PH.1; PH.2; PH.3		
12230 0...3	Poqidriv PZ.0; PZ.1; PZ.2; PZ.3		
12330 04...07	Slotted 4; 5.5; 7 mm		
12430 02...10	Hex 2; 3; 4; 5; 6; 7; 8; 10 mm		
12730 10...40	Star tamperproof T-10H; T15H; T-20H; T-25H; T-27H; T-30H; T-40H		
525 04...10	9-6pt. Flank socket 4; 4.5; 5; 5.5; 6; 7; 8; 9; 10 mm		
526 04...08	5-Star socket E4; E5; E6; E7; E8 mm		
80222	1-24 teeth ratchet		
8042 050...150	3-Extension bar 2"; 4"; 6"		
80521	1-Universal joint		
80632	1- Adaptor for Extension 3/8"(F) x 1/4"(M)		
81022	1-Bit holder		
8111	1-Flexible extension		
8143	1-Spinner		
3/8"DR. Part:			
539 06...22	15-12pt. Flank socket 6; 7; 8; 9; 10; 11; 12; 13; 14; 15; 17; 18; 19; 21; 22 mm		
802318	1-Flexible ratchet		
8043 075...150	2-Extension bar 3"; 6"		
80531	1-Universal joint		











<b>41421</b>			
Part no.	Socket	2/26.0/27.0/1.54'	13kg
	1/2"DR. Part:		
545 08...32	19-6pt. Flank socket 8; 10; 12; 13; 14; 15; 16; 17; 18; 19; 20; 21; 22; 23; 24; 25; 27; 30; 32 mm		
546 10...20	5-Star socket E10; E12; E14; E16; E20 mm		
8014430	1-Swivel handle (430mmL)		
80243	1-24 teeth thin ratchet		
8044 075...250	2-Extension bar 3" ; 10"		
80541	1-Universal joint		
80634	1-Adaptor for Extension 3/8"(F) x 1/2"(M)		
8074 16...20.6	2-Spark plug socket 16 ; 20.6 mm		
8154260	1-L handle		
	Others:		
755 06...24	17-Combination wrench 6; 7; 8; 9; 10; 11; 12; 13; 14; 15; 16; 17; 18; 19; 21; 22; 24 mm		
751 0810...1719	5-Flare nut wrench 8x10; 10x12; 11x13; 12x14; 17x19 mm		
764 025...14	10-Hex key 2.5; 3; 4; 5; 6; 7; 8; 10; 12; 14 mm		
616300	1-Engineering hammer 300gw		
611B175	1-Combination pliers 7"		
614250	1-Locking pliers 10"		
7111BS	1-Stubby phillips screwdriver PH.1		
7112B	1-Phillips screwdriver PH.2		
7112M	1-Hammer phillips screwdriver PH.2		
713055BS	1-Stubby slotted screwdriver 5.5mm x 25mmL		
713065B	1-Slotted screwdriver 6.5mm x 150mmL		
713065M	1-Hammer slotted screwdriver 6.5mm x 150mmL		
<b>41421-9</b>			
Part no.	Socket	2/26.0/27.0/1.54'	13kg
Changed Items	Content: 1/4" & 3/8" & 1/2"DR.		
	1/4"DR. Part:		
529 04...10	9-12pt. Flank socket 4; 4.5; 5; 5.5; 6; 7; 8; 9; 10 mm		
	1/2"DR. Part:		
549 08...32	19-12pt. Flank socket 8; 10; 12; 13; 14; 15; 16; 17; 18; 19; 20; 21; 22; 23; 24; 25; 27; 30; 32 mm		





<b>163pc Socket set</b>			
<b>41631S</b>			
Part no.	Socket	1/13.5/14.5/0.4' 1/6.0/8.0/1.25'	19.5kg
50141S	1-Short socket storage		
545 10...32	163-6pt. Flank socket Each 13pcs - 10; 11; 12; 13; 14 mm Each 12pcs - 16; 17 mm Each 10pcs - 19; 21 mm Each 9pcs - 22; 23 mm Each 8pcs - 24; 26 mm Each 7pcs - 27; 30 mm Each 6pcs - 32 mm		
<b>41631S-7</b>			
Part no.	Socket	1/13.5/14.5/0.4' 1/6.0/8.0/1.25'	19.5kg
50141S	1-Short socket storage		
547 10...32	163-Surface drive socket Each 13pcs - 10; 11; 12; 13; 14 mm Each 12pcs - 16; 17 mm Each 10pcs - 19; 21 mm Each 9pcs - 22; 23 mm Each 8pcs - 24; 26 mm Each 7pcs - 27; 30 mm Each 6pcs - 32 mm		
<b>41631S-9</b>			
Part no.	Socket	1/13.5/14.5/0.4' 1/6.0/8.0/1.25'	19.5kg
50141S	1-Short socket storage		
549 10...32	163-12pt. Flank socket Each 13pcs - 10; 11; 12; 13; 14 mm Each 12pcs - 16; 17 mm Each 10pcs - 19; 21 mm Each 9pcs - 22; 23 mm Each 8pcs - 24; 26 mm Each 7pcs - 27; 30 mm Each 6pcs - 32 mm		



**163pc Deep socket set**



<b>41631D</b>			
Part no.	Socket	1/36.0/37.0/1.2' 1/6.3/7.3/1.17'	42.3kg
50141D 54577 10...32	1-Deep socket storage 163-6pt. Flank socket Each 13pcs - 10; 11; 12; 13; 14 mm Each 12pcs - 16; 17 mm Each 10pcs - 19; 21 mm Each 9pcs - 22; 23 mm Each 8pcs - 24; 26 mm Each 7pcs - 27; 30 mm Each 6pcs - 32 mm		
<b>41631D-7</b>			
Part no.	Socket	1/36.0/37.0/1.2' 1/6.3/7.3/1.17'	42.3kg
50141D 54777 10...32	1-Deep socket storage 163-Surface drive socket Each 13pcs - 10; 11; 12; 13; 14 mm Each 12pcs - 16; 17 mm Each 10pcs - 19; 21 mm Each 9pcs - 22; 23 mm Each 8pcs - 24; 26 mm Each 7pcs - 27; 30 mm Each 6pcs - 32 mm		
<b>41631D-9</b>			
Part no.	Socket	1/36.0/37.0/1.2' 1/6.3/7.3/1.17'	42.3kg
50141D 54977 10...32	1-Deep socket storage 163-12pt. Flank socket Each 13pcs - 10; 11; 12; 13; 14 mm Each 12pcs - 16; 17 mm Each 10pcs - 19; 21 mm Each 9pcs - 22; 23 mm Each 8pcs - 24; 26 mm Each 7pcs - 27; 30 mm Each 6pcs - 32 mm		

**23pc CabinBox Main set**



<b>4234A</b>			
Part no.	Socket	4/16.5/17.5/0.9'	4125g
545 10...32	Content: 1/2"DR. 18-6pt. Flank socket 10; 11; 12; 13; 14; 15; 16; 17; 18; 19; 20; 21; 22; 23; 24; 27; 30; 32 mm		
80249	1-72 teeth ratchet handle		
8044 125...250	2-Extension bar 5"; 10"		
80541	1-Universal joint		
80634	1-Adaptor for extension 3/8"(F)x1/2"(M)		



**4234A+2421 CabinBox set**



<b>4234A+2421</b>			
Part no.	Socket	4/20.1/21.1/0.9'	5025g
545 10...32	4234A Content: 1/2"DR. 18-6pt. Flank socket 10; 11; 12; 13; 14; 15; 16; 17; 18; 19; 20; 21; 22; 23; 24; 27; 30; 32 mm		
80249	1-72 teeth ratchet handle		
8044 125...250	2-Extension bar 5"; 10"		
80541	1-Universal joint		
80634	1-Adaptor for extension 3/8"(F)x1/2"(M)		
525 032...14	2421 Content: 1/4"DR. 14-6pt. Flank socket 3.2; 4; 4.5; 5; 5.5; 6; 7; 8; 9; 10; 11; 12; 13; 14 mm		
	20-1/4" Bit 25mmL		
12425 03...08	Hex 3, 4, 5, 6, 8 mm		
12625 10...40	Star T10, T15, T20, T25, T30, T40		
12325 04...065	Slotted 4, 5.5, 6.5 mm		
12125 1...3	Phillips PH.1, PH.2, PH.3		
12225 1...3	Pozidriv PZ.1, PZ.2, PZ.3		
80229	1-72 teeth ratchet handle		
8042 050...150	2-Extension bar 2"; 6"		
80521	1-Universal joint		
81022	1-Bit holder 1/4"(F)x1/4"(F)		
8143	1-Spinner		
80632	1-Adaptor for extension 3/8"(F)x1/4"(M)		
81225	1-Magnetic socket pick up		

**4234A+4102 23pc CabinBox Main set**



<b>4234A+4102</b>			
Part no.	Socket	4/20.1/21.1/0.9'	5225g
545 10...32	4234A Content: 1/2"DR. 18-6pt. Flank socket 10; 11; 12; 13; 14; 15; 16; 17; 18; 19; 20; 21; 22; 23; 24; 27; 30; 32 mm		
80249	1-72 teeth ratchet handle		
8044 125...250	2-Extension bar 5"; 10"		
80541	1-Universal joint		
80634	1-Adaptor for extension 3/8"(F)x1/2"(M)		
346055 20...60	4102 Content: 1/2"DR. 9-Star socket bit T20; T25; T27; T30; T40; T45; T50; T55; T60 (55mmL)		



**23pc CabinBox Main set**

<b>4234B</b>			
Part no.	Socket	3/13.5/14.5/1'	4500g
545 10...32	Content: 1/2"DR. 18-6pt. Flank socket 10; 11; 12; 13; 14; 15; 16; 17; 18; 19; 20; 21; 22; 23; 24; 27; 30; 32 mm		
80249	1-72 teeth ratchet handle		
8044 125...250	2-Extension bar 5"; 10"		
80541	1-Universal joint		
80634	1-Adaptor for extension 3/8"(F)x1/2"(M)		



**4234B+2641 CabinBox set**

<b>4234B+2641</b>			
Part no.	Socket	3/19.0/20.0/1'	7000g
545 10...32	4234B Content: 1/2"DR. 18-6pt. Flank socket 10; 11; 12; 13; 14; 15; 16; 17; 18; 19; 20; 21; 22; 23; 24; 27; 30; 32 mm		
80249	1-72 teeth ratchet handle		
8044 125...250	2-Extension bar 5"; 10"		
80541	1-Universal joint		
80634	1-Adaptor for extension 3/8"(F)x1/2"(M)		
525 032...14	2641 Content: 1/4"DR. 14-6pt. Flank socket 3.2; 4; 4.5; 5; 5.5; 6; 7; 8; 9; 10; 11; 12; 13; 14 mm		
52550 05...13	9-6pt. Flank deep socket 5; 6; 7; 8; 9; 10; 11; 12; 13 mm 24-Socket bit(32mmL)		
32432 03...10	Hex 3; 4; 5; 6; 7; 8; 10 mm		
32132 1...3	Phillips PH.1; PH.2; PH.3		
32232 1...3	Pozidriv PZ.1; PZ.2; PZ.3		
32332 04...065	Slotted 4; 5.5; 6.5 mm		
32632 08...40	Star T8; T10; T15; T20; T25; T27; T30; T40		
80229	1-72 teeth Ratchet handle		
8042 050...150	3-Extension bar 2"; 4"; 6"		
8032115	1-Sliding T handle		
80521	1-Universal joint		
8143	1-Spinner 6"		
81225	1-Magnetic socket pick-up		
5102XLB	10-Hex ball point extra long key		
765 0127XL...	1.27; 1.5; 2; 2.5; 3; 4; 5; 6; 8; 10 mm		
10XL			







**4234B+3251-5 CabinBox set**

<b>4234B+3251-5</b>			
Part no.	Socket	3/21.0/22.0/1'	7000g
545 10...32	4234B Content: 1/2"DR. 18-6pt. Flank socket 10; 11; 12; 13; 14; 15; 16; 17; 18; 19; 20; 21; 22; 23; 24; 27; 30; 32 mm		
80249	1-72 teeth ratchet handle		
8044 125...250	2-Extension bar 5"; 10"		
80541	1-Universal joint		
80634	1-Adaptor for extension 3/8"(F)x1/2"(M)		
535 06...22	3251-5 Content: 3/8" DR. 17-6pt. Flank socket 6; 7; 8; 9; 10; 11; 12; 13; 14; 15; 16; 17; 18; 19; 20; 21; 22 mm		
80232	1-Ratchet handle		
8043 075...150	2-Extension bar 3"; 6"		
80531	1-Universal joint		
8033165	1-Sliding T handle		
8073 16...20.6	2-Spark plug socket 16mm; 20.6mm		



**4234B+3361 CabinBox set**

<b>4234B+3361</b>			
Part no.	Socket	3/23.8/24.8/1'	7910g
545 10...32	4234B Content: 1/2"DR. 18-6pt. Flank socket 10; 11; 12; 13; 14; 15; 16; 17; 18; 19; 20; 21; 22; 23; 24; 27; 30; 32 mm		
80249	1-72 teeth ratchet handle		
8044 125...250	2-Extension bar 5"; 10"		
80541	1-Universal joint		
80634	1-Adaptor for extension 3/8"(F)x1/2"(M)		
535 06...22	3361 Content: 3/8" DR. 17-6pt. Flank socket 6; 7; 8; 9; 10; 11; 12; 13; 14; 15; 16; 17; 18; 19; 20; 21; 22 mm		
80239	1-72 teeth ratchet handle		
8043 075...225	3-Extension bar 3"; 6"; 9"		
8073 16...20.6	2-Spark plug socket 16; 20.6 mm		
80531	1-Universal joint		
80643	3-Adaptor for extension 1/2"(F)x3/8"(M)		
755 07...17	11-Combination wrench 7, 8, 9, 10, 11, 12, 13, 14, 15, 16, 17 mm		







**4234B+4411 CabinBox set**



<b>4234B+4411</b>			
Part no.	Socket	3/21.5/22.5/1'	6966g
545 10...32	4234B Content: 1/2"DR. 18-6pt. Flank socket 10; 11; 12; 13; 14; 15; 16; 17; 18; 19; 20; 21; 22; 23; 24; 27; 30; 32 mm		
80249	1-72 teeth ratchet handle		
8044 125...250	2-Extension bar 5"; 10"		
80541	1-Universal joint		
80634	1-Adaptor for extension 3/8"(F)x1/2"(M)		
766 09...70	4411 Content: 1/4" & 3/8" & 1/2" DR. 19-Star L key T9; T10; T15; T20; T25; T27; T30; T40; T45; T50; T55; T60; T70		
12630 09...20	4-1/4" star bit (30mmL) T9; T10; T15; T20		
17630 25...50	6-10mm star bit (30mmL) T25; T27; T30; T40; T45; T50		
17611555	1-10mm star bit T55 (115mmL)		
19675 60...70	2-14mm star bit (75mmL) T60; T70		
526 04...08	5-1/4"DR. star socket E4; E5; E6; E7; E8		
536 10...20	7-3/8"DR. star socket E10; E11; E12; E14; E16; E18; E20		
810 22...414	3-Bit holder 1/4"DR.x1/4"; 3/8"DR.x10mm; 1/2"DR.x14mm		

**4234B+5161 CabinBox set**



<b>4234B+5161</b>			
Part no.	Socket	3/20.5/21.5/1'	6833g
545 10...32	4234B Content: 1/2"DR. 18-6pt. Flank socket 10; 11; 12; 13; 14; 15; 16; 17; 18; 19; 20; 21; 22; 23; 24; 27; 30; 32 mm		
80249	1-72 teeth ratchet handle		
8044 125...250	2-Extension bar 5"; 10"		
80541	1-Universal joint		
80634	1-Adaptor for extension 3/8"(F)x1/2"(M)		
755 06...24	5161 Content: 16-Combination wrench 6; 7; 8; 9; 10; 11; 12; 13; 14; 15; 16; 17; 18; 19; 22; 24 mm		



**24pc CabinBox Main set**



<b>4243B</b>			
Part no.	Socket	3/15.5/16.5/1'	5230g
545 10...32	Content: 1/2"DR. 18-6pt. Flank socket 10; 11; 12; 13; 14; 15; 16; 17; 18; 19; 20; 21; 22; 23; 24; 27; 30; 32 mm		
80249	1-72 teeth ratchet handle		
8014380	1-Swivel handle 15"		
8044 125...250	2-Extension bar 5"; 10"		
80541	1-Universal joint		
80634	1-Adaptor for extension 3/8"(F)x1/2"(M)		

**4243B+2203-72-5 CabinBox set**



<b>4243B+ 2203-72-5</b>			
Part no.	Socket	3/18.8/19.8/1'	6290g
545 10...32	4243B Content: 1/2"DR. 18-6pt. Flank socket 10; 11; 12; 13; 14; 15; 16; 17; 18; 19; 20; 21; 22; 23; 24; 27; 30; 32 mm		
80249	1-72 teeth ratchet handle		
8014380	1-Swivel handle 15"		
8044 125...250	2-Extension bar 5"; 10"		
80541	1-Universal joint		
80634	1-Adaptor for extension 3/8"(F)x1/2"(M)		
525 04...14	2203-72-5 Content: 1/4"DR. 13-6pt. Flank socket 4; 4.5; 5; 5.5; 6; 7; 8; 9; 10; 11; 12; 13; 14 mm		
80229	1-72 teeth ratchet handle		
8042 050...150	2-Extension bar 2"; 6"		
80521	1-Universal joint		
8032115	1-Sliding T handle		
8145	1-Spinner		



**4243B+2253-72 CabinBox set**

<b>4243B+2253-72</b>			
Part no.	Socket	3/20.0/21.0/1'	6660g
545 10...32	4243B Content: 1/2"DR. 18-6pt. Flank socket 10; 11; 12; 13; 14; 15; 16; 17; 18; 19; 20; 21; 22; 23; 24; 27; 30; 32 mm		
80249	1-72 teeth ratchet handle		
8014380	1-Swivel handle 15"		
8044 125...250	2-Extension bar 5"; 10"		
80541	1-Universal joint		
80634	1-Adaptor for extension 3/8"(F)x1/2"(M)		
525 04...13	2253-72 Content: 1/4"DR. 11-6pt. Flank socket 4; 5; 5.5; 6; 7; 8; 9; 10; 11; 12; 13 mm		
52550 05...13	9-6pt. Flank deep socket 5; 6; 7; 8; 9; 10; 11; 12; 13 mm		
80229	1-72 teeth ratchet handle		
8042 050...150	2-Extension bar 2"; 6"		
8143	1-Spinner		

**4243B+2281-72-5 CabinBox set**

<b>4243B+2281-72-5</b>			
Part no.	Socket	3/19.6/20.6/1'	6530g
545 10...32	4243B Content: 1/2"DR. 18-6pt. Flank socket 10; 11; 12; 13; 14; 15; 16; 17; 18; 19; 20; 21; 22; 23; 24; 27; 30; 32 mm		
80249	1-72 teeth ratchet handle		
8014380	1-Swivel handle 15"		
8044 125...250	2-Extension bar 5"; 10"		
80541	1-Universal joint		
80634	1-Adaptor for extension 3/8"(F)x1/2"(M)		
525 04...14	2281-72-5 Content: 1/4"DR. 11-6pt. Flank socket 4; 5; 6; 7; 8; 9; 10; 11; 12; 13; 14 mm		
32432 03...06	10-Socket bit(32mmL) Hex 3; 4; 5; 6 mm		
32332 04...07	Slotted 4; 5.5; 7 mm		
32132 1...3	Phillips PH.1; PH.2; PH.3		
80229	1-72 teeth ratchet handle		
8042 050...150	2-Extension bar 2"; 6"		
8032115	1-Sliding T handle		
80521	1-Universal joint		
8143	1-Spinner		



**4243B+2571 CabinBox set**

**4243B+2571**



Part no.	Socket	3/19.9/20.9/0.95'	6630g
545 10...32	4243B Content: 1/2"DR. 18-6pt. Flank socket 10; 11; 12; 13; 14; 15; 16; 17; 18; 19; 20; 21; 22; 23; 24; 27; 30; 32 mm		
80249	1-72 teeth ratchet handle		
8014380	1-Swivel handle 15"		
8044 125...250	2-Extension bar 5"; 10"		
80541	1-Universal joint		
80634	1-Adaptor for extension 3/8"(F)x1/2"(M)		
525 04...14	2571 Content: 1/4"DR. 13-6pt. Flank socket 4; 4.5; 5; 5.5; 6; 7; 8; 9; 10; 11; 12; 13; 14 mm		
52550 06...10	4-6pt. Flank deep socket 6; 7; 8; 10 mm		
32132 1...3	24-Socket bit(32mmL) Phillips PH.1; PH.2; PH.3		
32232 1...3	Pozidriv PZ.1; PZ.2; PZ.3		
32332 04...065	Slotted 4; 5.5; 6.5 mm		
32432 03...10	Hex 3; 4; 5; 6; 7; 8; 10 mm		
32632 08...40	Star T8; T10; T15; T20; T25; T27; T30; T40		
526 04...10	6-Star socket E4; E5; E6; E7; E8; E10		
80229	1-72 teeth ratchet handle		
8032115	2-Sliding T handle		
8042 050...100	1-Extension bar 2"; 4"		
80521	1-Universal joint		
8143	1-Spinner		
764-4	4-Hex key 1.27; 1.5; 2; 2.5 mm		

**10mm Hex bit**

<b>174</b>		<i>l</i>		
Part no.	size	mm	g	pc/box
1743004	4	30	13	10
1743005	5	30	14	10
1743006	6	30	14	10
1743007	7	30	16	10
1743008	8	30	17	10
1743010	10	30	20	10
1743012	12	30	25	10
1747504	4	75	43	10
1747505	5	75	43	10
1747506	6	75	44	10
1747507	7	75	45	10
1747508	8	75	47	10
1747510	10	75	50	10
1747512	12	75	67	10

**10mm Star bit**

<b>176</b>		<i>l</i>		
Part no.	size	mm	g	pc/box
1763010	T10	30	12	10
1763015	T15	30	12	10
1763020	T20	30	13	10
1763025	T25	30	13	10
1763027	T27	30	14	10
1763030	T30	30	14	10
1763040	T40	30	14	10
1763045	T45	30	15	10
1763047	T47	30	16	10

**10mm Star bit**

<b>176</b>		<i>l</i>		
Part no.	size	mm	g	pc/box
1763050	T50	30	16	10
1763055	T55	30	18	10
1763060	T60	30	22	10
1767510	T10	75	41	10
1767515	T15	75	41	10
1767520	T20	75	42	10
1767525	T25	75	42	10
1767527	T27	75	42	10
1767530	T30	75	43	10
1767540	T40	75	44	10
1767545	T45	75	45	10
1767550	T50	75	45	10
1767555	T55	75	48	10
1767560	T60	75	64	10
17611555	T55	115	70	10
17612040	T40	120	72	10
17612045	T45	120	72	10
17612050	T50	120	74	10
17612055	T55	120	74	10





**14mm Star bit**

<b>196</b>		<i>l</i>		
Part no.	size	mm	g	pc/box
1965060	T60	50	56	10
1965070	T70	50	60	10
1967560	T60	75	88	10
1967570	T70	75	93	10









**10mm Star tamperproof bit**



<b>177</b>				
Part no.	size	mm	g	pc/box
1773010	T-10H	30	14	10
1773015	T-15H	30	14	10
1773020	T-20H	30	14	10
1773025	T-25H	30	14	10
1773027	T-27H	30	14	10
1773030	T-30H	30	14	10
1773040	T-40H	30	14	10
1773045	T-45H	30	16	10
1773050	T-50H	30	16	10
1773055	T-55H	30	18	10
1773060	T-60H	30	22	10
1777510	T-10H	75	42	10
1777515	T-15H	75	42	10
1777520	T-20H	75	42	10
1777525	T-25H	75	42	10
1777527	T-27H	75	42	10
1777530	T-30H	75	42	10
1777540	T-40H	75	44	10
1777545	T-45H	75	44	10
1777550	T-50H	75	46	10
1777555	T-55H	75	48	10
1777560	T-60H	75	66	10

**10mm Spline bit**

<b>178</b>				
Part no.	size	mm	g	pc/box
1783005	M5	30	13	10
1783006	M6	30	14	10
1783008	M8	30	15	10
1783010	M10	30	17	10
1783012	M12	30	20	10
1787505	M5	75	43	10
1787506	M6	75	43	10
1787508	M8	75	44	10
1787510	M10	75	47	10
1787512	M12	75	58	10
17812008	M8	120	74	10
17812010	M10	120	77	10
17812012	M12	120	106	10





**10mm Ribbit**

<b>179</b>		<i>l</i>		
Part no.	size	mm	g	pc/box
1793004	M4	30	14	10
1793005	M5	30	14	10
1793006	M6	30	14	10
1793007	M7	30	14	10
1793008	M8	30	14	10
1793009	M9	30	18	10
1793010	M10	30	18	10
1793012	M12	30	20	10
1793013	M13	30	22	10
1793014	M14	30	24	10
1797504	M4	75	42	10
1797505	M5	75	42	10
1797506	M6	75	42	10
1797507	M7	75	42	10
1797508	M8	75	44	10
1797509	M9	75	46	10
1797510	M10	75	47	10
1797512	M12	75	63	10
1797513	M13	75	78	10
1797514	M14	75	79	10





**1/2" Phillips socket bit**

<b>341</b>		<i>l</i>		
Part no.	size	mm	g	pc/box
341552	PH.2	55	63	10
341553	PH.3	55	65	10
341554	PH.4	55	70	10





**1/2" Pozidriv socket bit**

<b>342</b>		<i>l</i>		
Part no.	size	mm	g	pc/box
342552	PZ.2	55	65	10
342553	PZ.3	55	65	10
342554	PZ.4	55	70	10







**1/2" Slotted socket bit (one-piece)**

<b>343</b>		<i>l</i>		
Part no.	size	mm	g	pc/box
34313	13	38	77	10
34319	19	38	84	10
34324	24	38	86	10







**1/2" Slotted socket bit**

<b>343</b>				
Part no.	size	mm	g	pc/box
3435508	1.2 x 8	55	70	10
3435509	1.6 x 9	55	70	10
3435510	1.6 x 10	55	70	10
3435511	1.8 x 11	55	92	10
3435512	2.0 x 12	55	102	10
3435514	2.5 x 14	55	112	10
3435516	2.5 x 16	55	112	10









**1/2" Hex socket bit (one-piece)**

<b>344</b>				
Part no.	size	mm	g	pc/box
34404	4	38	56	10
34405	5	38	56	10
34406	6	38	58	10
34407	7	38	59	10
34408	8	38	71	10
34410	10	40	76	10
34412	12	40	83	10
34414	14	40	91	10
34417	17	42	103	10
34419	19	42	112	10



**1/2" Hex socket bit**



<b>344</b>				
Part no.	size	mm	g	pc/box
34405504	4	55	62	10
34405505	5	55	64	10
34405506	6	55	65	10
34405507	7	55	68	10
34405508	8	55	69	10
34405509	9	55	79	10
34405510	10	55	80	10
34405512	12	55	103	10
34406514	14	65	149	10
34407017	17	70	196	10
34407019	19	70	235	10
3440555.32	5/32"	55	63	10
3440553.16	3/16"	55	63	10
3440557.32	7/32"	55	63	10
3440551.4	1/4"	55	63	10
3440555.16	5/16"	55	69	10
3440553.8	3/8"	55	79	10
3440557.16	7/16"	55	102	10
3440551.2	1/2"	55	112	10
3440659.16	9/16"	65	150	10
3440655.8	5/8"	65	154	10
3440703.4	3/4"	70	242	10
34407006	6	70	70	10
34408006	6	80	75	10
34408008	8	80	80	10
34410005	5	100	78	10
34410006	6	100	78	10
34410007	7	100	87	10
34410008	8	100	88	10
34410010	10	100	108	10
34410011	11	100	144	10
34410012	12	100	145	10
34410013	13	100	148	10
34410014	14	100	197	10

<b>344</b>		<i>l</i>		
Part no.	size	mm	g	pc/box
34411005	5	110	85	10
34411006	6	110	85	10
34411007	7	110	91	10
34411008	8	110	93	10
34411010	10	110	117	10
34411012	12	110	162	10
34411014	14	110	207	10
34411017	17	110	274	10
34411019	19	110	331	10
34412008	8	120	100	10
34413008	8	130	105	10
34414006	6	140	89	10
34414008	8	140	101	10
34414010	10	140	139	10
34414012	12	140	186	10
34414014	14	140	245	10
34416006	6	160	95	10
34418005	5	180	120	10
34419008	8	190	130	10
34422006	6	220	115	10
34424806	6	248	125	10



\* 34410011: for VW-Audi, Seat, Skoda petrol engines. to remove and replace the plastic insert for injector valves.

\* 34410013: for VW-Audi, Seat, Skoda 4 Cylinder TDI PD engines. To loosen and fasten of the central retaining bolt of Fuel Cooling Unit, example to replace the Fuel filter.

**1/2" Hex ball point socket bit**



<b>345</b>		<i>l</i>		
Part no.	size	mm	g	pc/box
34510005	5	100	76	10
34510006	6	100	80	10
34510008	8	100	88	10
34510010	10	100	108	10
34524005	5	240	125	10
34524008	8	240	130	10





**1/2" Star socket bit (one-piece)**

<b>346</b>		<i>l</i>		
Part no.	size	mm	g	pc/box
34620	T20	37	63	10
34625	T25	37	63	10
34627	T27	37	68	10
34630	T30	37	68	10
34640	T40	37	68	10
34645	T45	37	70	10
34647	T47	37	71	10
34650	T50	40	72	10
34655	T55	40	75	10
34660	T60	40	77	10



**1/2" Star socket bit**





<b>346</b>		<i>l</i>		
Part no.	size	mm	g	pc/box
34605520	T20	55	62	10
34605525	T25	55	63	10
34605527	T27	55	63	10
34605530	T30	55	63	10
34605540	T40	55	64	10
34605545	T45	55	67	10
34605547	T47	55	67	10
34605550	T50	55	68	10
34605555	T55	55	79	10
34605560	T60	55	101	10
34605570	T70	55	132	10
34607080	T80	70	185	10
34610020	T20	100	74	10
34610025	T25	100	74	10
34610027	T27	100	75	10
34610030	T30	100	76	10
34610040	T40	100	76	10
34610045	T45	100	86	10
34610050	T50	100	87	10
34610055	T55	100	108	10
34610060	T60	100	146	10
34610070	T70	100	191	10
34610080	T80	100	246	10
34610090	T90	100	299	5
346100100	T100	100	350	5
34611050R	T50	110	121	10
34612040	T40	120	90	10
34612045	T45	120	100	10
34612070	T70	120	211	10
34614045	T45	140	103	10
34614050	T50	140	104	10

<b>346</b>		<i>l</i>		
Part no.	size	mm	g	pc/box
34614055	T55	140	138	10
34614060	T60	140	184	10
34614070	T70	140	198	10
34614090	T90	140	233	10
346140100	T100	140	241	10
34620030	T30	200	110	10
34620040	T40	200	110	10
34620045	T45	200	135	10
34620050	T50	200	138	10





\* 34611050R bit is made by 10mm round steel, be applied in alternator of vehicle.(see no.678)



**1/2" Star tamperproof socket bit**

<b>347</b>				
Part no.	size	mm	g	pc/box
34705520	T-20H	55	62	10
34705525	T-25H	55	62	10
34705527	T-27H	55	62	10
34705530	T-30H	55	62	10
34705540	T-40H	55	64	10
34705545	T-45H	55	68	10
34705550	T-50H	55	68	10
34705555	T-55H	55	78	10
34705560	T-60H	55	104	10
34705570	T-70H	55	131	10
34707080	T-80H	70	139	10
34710020	T-20H	100	76	10
34710025	T-25H	100	76	10
34710027	T-27H	100	76	10
34710030	T-30H	100	76	10
34710040	T-40H	100	76	10
34710045	T-45H	100	85	10
34710050	T-50H	100	87	10
34710055	T-55H	100	108	10
34710060	T-60H	100	143	10
34710070	T-70H	100	189	10
34710080	T-80H	100	238	10
34710090	T-90H	100	296	5
347100100	T-100H	100	346	5
34710570	T-70H	105	168	10
34712070	T-70H	120	212	10
34713030	T-30H	130	85	10
34714055	T-55H	140	137	10
34714090	T-90H	140	392	5
347140100	T-100H	140	461	5

**1/2" Spline socket bit**

<b>348</b>				
Part no.	size	mm	g	pc/box
34805505	M5	55	67	10
34805506	M6	55	67	10
34805508	M8	55	67	10
34805509	M9	55	77	10
34805510	M10	55	78	10
34805512	M12	55	100	10
34805514	M14	55	131	10
34805516	M16	55	162	10
34810005	M5	100	80	10
34810006	M6	100	85	10
34810008	M8	100	87	10
34810009	M9	100	95	10
34810010	M10	100	108	10
34810012	M12	100	151	10
34810014	M14	100	187	10
34810016	M16	100	242	10
34811010R	M10	110	121	10
34812008	M8	120	95	10
34812009	M9	120	121	10
34812010	M10	120	121	10
34814008	M8	140	110	10
34814009	M9	140	140	10
34814010	M10	140	140	10
34814012	M12	140	152	10
34814014	M14	140	256	10
34880008	M8	800	610	10
34880010	M10	800	616	10

\* 34707080 : For removal and replacement of the wind screen wiper arm and adjusting the pressure on BMW E31, E38 AND E39.





\* 34713030 T-30H 130mmL  
To remove and replace the screws on airbag of BMW, Mercedes, VW, Audi.

\* 34880008, 34880010

Special 800mm length provides access to Axle Shafts for removal & replacement on AUDI/VW vehicles

\* 34811010R bit is made by 10mm round steel, be applied in alternator of vehicle.(see no.674)





**1/2" DR. Spline Security socket bit**

<b>348..T</b>				
Part no.	size	mm	g	pc/box
34805516T	M16	55	161	10
34810016T	M16	100	240	10

\* For removal and replacement of the gear box drain plug Audi A3,A4,A6;VW Golf IV,LT.



**1/2" Ribe socket bit**

<b>349</b>				
Part no.	size	mm	g	pc/box
34905506	M6	55	70	10
34910005	M5	100	82	10
34910006	M6	100	82	10
34910007	M7	100	82	10
34910008	M8	100	82	10
34910009	M9	100	106	10
34910010	M10	100	122	10
34910012	M12	100	150	10
34910013	M13	100	185	10
34910014	M14	100	187	10
34910016	M16	100	237	10
34912009	M9	120	148	10
34914008	M8	140	102	10
34914010	M10	140	136	10
34914012	M12	140	178	10
34914014	M14	140	286	10
34924806	M6	248	125	10
34924807	M7	248	149	10
34924808	M8	248	150	10

Ribe socket bit :





\* To remove and fasten cylinder-head retaining bolts on FIAT engines.



\* 34914010-M10 140mmL



Special for Audi engines, and VW-Passat cylinder head screws.



**1/2" DR. 6pt. Flank socket**



<b>545</b>				
Part no.	Socket	mm	g	pc/box
54508	8	38	50	10
54509	9	38	50	10
54510	10	38	52	10
54511	11	38	52	10
54512	12	38	53	10
54513	13	38	53	10
54514	14	38	55	10
54515	15	38	55	10
54516	16	38	59	10
54517	17	38	65	10
54518	18	38	78	10
54519	19	38	79	10
54520	20	38	81	10
54521	21	38	95	10
54522	22	38	96	10
54523	23	40	116	10
54524	24	40	117	10
54525	25	43	119	10
54526	26	43	138	10
54527	27	43	144	10
54528	28	43	162	10
54529	29	43	162	10
54530	30	45	173	10
54531	31	45	174	10
54532	32	45	176	10
5455.16	5/16"	38	50	10
5453.8	3/8"	38	53	10
5457.16	7/16"	38	53	10
54515.32	15/32"	38	53	10
5451.2	1/2"	38	54	10
5459.16	9/16"	38	55	10
54519.32	19/32"	38	55	10
5455.8	5/8"	38	60	10
54511.16	11/16"	38	63	10
5453.4	3/4"	38	70	10
54525.32	25/32"	38	79	10

<b>545</b>		<i>l</i>		
Part no.	Socket	mm	g	pc/box
54513.16	13/16"	38	79	10
5457.8	7/8"	38	96	10
54515.16	15/16"	40	109	10
5451.0	1"	43	140	10
5451.1.16	1-1/16"	43	144	10
5451.1.8	1-1/8"	45	147	10
5451.3.16	1-3/16"	45	168	10
5451.1.4	1-1/4"	45	184	10

<b>54577</b>		<i>l</i>		
Part no.	Socket	mm	g	pc/box
5457726	26	77	289	10
5457727	27	77	297	10
5457728	28	77	317	10
5457729	29	77	333	10
5457730	30	77	352	10
5457731	31	77	384	10
5457732	32	77	420	10
545775.16	5/16"	77	77	10
545773.8	3/8"	77	79	10
545777.16	7/16"	77	81	10
545771.2	1/2"	77	94	10
545779.16	9/16"	77	105	10
545775.8	5/8"	77	122	10
5457711.16	11/16"	77	132	10
545773.4	3/4"	77	163	10
5457713.16	13/16"	77	207	10
545777.8	7/8"	77	220	10
5457715.16	15/16"	77	243	10
545771.0	1"	77	254	10
545771.1.16	1-1/16"	77	297	10
545771.1.8	1-1/8"	77	333	10
545771.3.16	1-3/16"	77	384	10
545771.1.4	1-1/4"	77	420	10





**1/2" DR. 6pt. Flank deep socket**

<b>54577</b>		<i>l</i>		
Part no.	Socket	mm	g	pc/box
5457708	8	77	73	10
5457709	9	77	77	10
5457710	10	77	79	10
5457711	11	77	81	10
5457712	12	77	86	10
5457713	13	77	94	10
5457714	14	77	105	10
5457715	15	77	111	10
5457716	16	77	122	10
5457717	17	77	132	10
5457718	18	77	157	10
5457719	19	77	163	10
5457720	20	77	171	10
5457721	21	77	207	10
5457722	22	77	220	10
5457723	23	77	236	10
5457724	24	77	243	10
5457725	25	77	254	10



**1/2" DR. Star socket**

<b>546</b>		<i>l</i>		
Part no.	Socket	mm	g	pc/box
54608	E8	38	50	10
54610	E10	38	52	10
54611	E11	38	52	10
54612	E12	38	5	10
54614	E14	38	55	10
54616	E16	38	57	10
54618	E18	38	59	10
54620	E20	38	64	10
54622	E22	38	85	10
54624	E24	40	100	10



**1/2" DR. Star Deep socket**

**54677**

Part no.	Socket	mm	g	pc/box
5467710	E10	77	84	10
5467711	E11	77	88	10
5467712	E12	77	93	10
5467714	E14	77	98	10
5467716	E16	77	119	10
5467718	E18	77	129	10
5467720	E20	77	171	10
5467724	E24	77	227	10



**1/2" DR. Surface drive socket**



**547**

Part no.	Socket	mm	g	pc/box
54708	8	38	50	10
54709	9	38	50	10
54710	10	38	51	10
54711	11	38	51	10
54712	12	38	51	10
54713	13	38	53	10
54714	14	38	55	10



547	Socket	mm	g	pc/box
54715	15	38	58	10
54716	16	38	58	10
54717	17	38	63	10
54718	18	38	77	10
54719	19	38	79	10
54720	20	38	79	10
54721	21	38	94	10
54722	22	38	94	10
54723	23	40	103	10
54724	24	40	109	10
54726	26	43	121	10
54727	27	43	139	10
54728	28	43	146	10
54730	30	45	167	10
54732	32	45	176	10
5475.16	5/16"	38	50	10
5473.8	3/8"	38	51	10
5477.16	7/16"	38	51	10
54715.32	15/32"	38	51	10
5471.2	1/2"	38	53	10
5479.16	9/16"	38	55	10
54719.32	19/32"	38	58	10
5475.8	5/8"	38	58	10
54711.16	11/16"	38	63	10
5473.4	3/4"	38	77	10
54725.32	25/32"	38	79	10
54713.16	13/16"	38	79	10
5477.8	7/8"	38	94	10
54715.16	15/16"	40	103	10
5471.0	1"	43	118	10
5471.1.16	1-1/16"	43	139	10
5471.1.8	1-1/8"	45	152	10
5471.3.16	1-3/16"	45	167	10
5471.1.4	1-1/4"	45	174	10



**1/2" DR. Surface drive deep socket**



<b>54777</b>		<i><b>l</b></i>		
Part no.	Socket	mm	g	pc/box
5477708	8	77	73	10
5477709	9	77	77	10
5477710	10	77	79	10
5477711	11	77	81	10
5477712	12	77	86	10
5477713	13	77	94	10
5477714	14	77	105	10
5477715	15	77	111	10
5477716	16	77	122	10
5477717	17	77	132	10
5477718	18	77	157	10
5477719	19	77	163	10
5477720	20	77	171	10
5477721	21	77	207	10
5477722	22	77	220	10
5477723	23	77	236	10
5477724	24	77	243	10
5477726	26	77	289	10
5477727	27	77	297	10
5477728	28	77	317	10
5477730	30	77	352	10
5477732	32	77	420	10

**1/2" DR. 12pt. WW Flank socket**



<b>548W</b>		<i><b>l</b></i>		
Part no.	Socket	mm	g	pc/box
548W3.16	3/16"	38	50	10
548W1.4	1/4"	38	52	10
548W5.16	5/16"	38	52	10
548W3.8	3/8"	38	72	10
548W7.16	7/16"	38	86	10
548W1.2	1/2"	40	102	10
548W9.16	9/16"	43	110	10
548W5.8	5/8"	45	146	10
548W3.4	3/4"	45	230	10





**1/2" DR. 12pt. Flank socket**

<b>549</b>		<i><b>l</b></i>		
Part no.	Socket	mm	g	pc/box
54908	8	38	51	10
54909	9	38	51	10
54910	10	38	51	10
54911	11	38	52	10
54912	12	38	52	10
54913	13	38	52	10
54914	14	38	54	10
54915	15	38	53	10
54916	16	38	58	10



<b>549</b>		<i>l</i>		
Part no.	Socket	mm	g	pc/box
54917	17	38	64	10
54918	18	38	80	10
54919	19	38	81	10
54920	20	38	86	10
54921	21	38	94	10
54922	22	38	94	10
54923	23	40	108	10
54924	24	40	108	10
54925	25	43	117	10
54926	26	43	124	10
54927	27	43	135	10
54928	28	43	138	10
54929	29	43	165	10
54930	30	45	168	10
54931	31	45	171	10
54932	32	45	176	10
5495.16	5/16"	38	50	10
5493.8	3/8"	38	51	10
5497.16	7/16"	38	51	10
54915.32	15/32"	38	51	10
5491.2	1/2"	38	53	10
5499.16	9/16"	38	55	10
54919.32	19/32"	38	58	10
5495.8	5/8"	38	58	10
54911.16	11/16"	38	63	10
5493.4	3/4"	38	77	10
54925.32	25/32"	38	79	10
54913.16	13/16"	38	79	10
5497.8	7/8"	38	94	10
54915.16	15/16"	40	103	10
5491.0	1"	43	118	10
5491.1.16	1-1/16"	43	139	10
5491.1.8	1-1/8"	45	152	10
5491.3.16	1-3/16"	45	167	10
5491.1.4	1-1/4"	45	174	10

**1/2" DR. 12pt. Flank deep socket**

<b>54977</b>		<i>l</i>		
Part no.	Socket	mm	g	pc/box
5497708	8	77	70	10
5497709	9	77	75	10
5497710	10	77	75	10
5497711	11	77	78	10
5497712	12	77	84	10
5497713	13	77	97	10
5497714	14	77	99	10
5497715	15	77	100	10
5497716	16	77	113	10
5497717	17	77	125	10
5497718	18	77	160	10
5497719	19	77	164	10
5497720	20	77	167	10
5497721	21	77	213	10
5497722	22	77	220	10
5497723	23	77	227	10
5497724	24	77	234	10
5497725	25	77	244	10
5497726	26	77	268	10
5497727	27	77	281	10
5497728	28	77	295	10
5497729	29	77	309	10
5497730	30	77	352	10
5497731	31	77	384	10
5497732	32	77	420	10

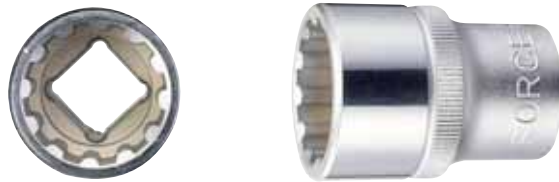

**1/2" DR. Spline socket**

<b>54Q</b>						<i>l</i>			
Part no.	size	6point	12point	SAE	E-Tox	XZN	mm	g	pc/box
54Q08	8	•	•		E10		38	44	10
54Q09	9	•	•		E11		38	44	10
54Q10	10	•	•	3/8"	E12	10	38	46	10
54Q11	11	•	•	7/16"	E14	11	38	46	10
54Q12	12	•	•	15/32"		12	38	48	10
54Q13	13	•	•	1/2"	E16		38	50	10
54Q14	14	•	•	9/16"	E18	14	38	52	10
54Q15	15	•	•	19/32"			38	56	10
54Q16	16	•	•	5/8"	E20	16	38	58	10
54Q17	17	•	•				38	72	10
54Q18	18	•	•		E22	18	38	78	10
54Q19	19	•	•	3/4"	E24		38	80	10
54Q20	20	•	•	25/32"		20	38	82	10
54Q21	21	•	•	13/16"			38	82	10
54Q22	22	•	•	7/8"		22	38	86	10
54Q23	23	•	•				40	100	10
54Q24	24	•	•	15/16"		24	40	112	10
54Q26	26	•	•				43	140	10
54Q27	27	•	•	1-1/16"			43	170	10
54Q28	28	•	•				43	180	10
54Q30	30	•	•	1-1/8"		30	45	210	10
54Q32	32	•	•	1-1/4"		32	45	230	10



**1/2" DR. Spline deep socket**

<b>54Q77</b>						<i>l</i>			
Part no.	size	6point	12point	SAE	E-Tox	XZN	mm	g	pc/box
54Q7708	8	•	•		E10		77	100	10
54Q7709	9	•	•		E11		77	100	10
54Q7710	10	•	•	3/8"	E12	10	77	100	10
54Q7711	11	•	•	7/16"	E14	11	77	103	10
54Q7712	12	•	•	15/32"		12	77	105	10
54Q7713	13	•	•	1/2"	E16		77	107	10
54Q7714	14	•	•	9/16"	E18	14	77	118	10
54Q7715	15	•	•	19/32"			77	125	10
54Q7716	16	•	•	5/8"	E20	16	77	140	10
54Q7717	17	•	•				77	150	10
54Q7718	18	•	•		E22	18	77	165	10
54Q7719	19	•	•	3/4"	E24		77	178	10
54Q7720	20	•	•	25/32"		20	77	180	10
54Q7721	21	•	•	13/16"			77	185	10
54Q7722	22	•	•	7/8"		22	77	205	10
54Q7723	23	•	•				77	245	10
54Q7724	24	•	•	15/16"		24	77	252	10
54Q7726	26	•	•				77	310	10
54Q7727	27	•	•	1-1/16"			77	345	10
54Q7728	28	•	•				77	365	10
54Q7730	30	•	•	1-1/8"		30	77	400	10
54Q7732	32	•	•	1-1/4"		32	77	410	10



**1/2" DR. Swivel handle**

<b>8014</b>	<b>l</b>		
Part no.	mm	g	pc/box
8014250	250-10"	516	5
8014380	380-15"	772	5
8014430	430-17"	886	5

\* Spare part available



**1/2" DR. Swivel handle**

<b>8014600</b>	<b>l</b>		
Part no.	mm	g	pc/box
8014600	600-24"	1400	5

\* Spare part available



**1/2" DR. Ratchet handle-24 teeth**

<b>80242</b>	<b>l</b>		
Part no.	mm	g	pc/box
80242	270	754	1

\* Spare part available



**1/2" DR. 72 teeth round ratchet handle**

<b>802422</b>	<b>l</b>		
Part no.	mm	g	pc/box
802422	253	488	1

\* Spare part available



**1/2" DR. 72 teeth flexible round ratchet handle**

<b>802423</b>	<b>l</b>		
Part no.	mm	g	pc/box
802423	303	656	1

\* Spare part available



**1/2" DR. Ratchet handle-24 teeth-Thin**

<b>80243</b>	<b>l</b>		
Part no.	mm	g	pc/box
80243	255	618	1

\* Spare part available



**1/2" DR. Ratchet handle-24 teeth-Thin**

<b>80244</b>	<b>l</b>		
Part no.	mm	g	pc/box
80244	245	644	1

\* Spare part available



**1/2" DR. Ratchet handle-24 teeth-RD**

<b>80245</b>	<b>l</b>		
Part no.	mm	g	pc/box
80245	245	662	1

\* Spare part available





**1/2" DR. Ratchet handle-32 teeth**

<b>80246</b>	<b>l</b>		
Part no.	mm	g	pc/box
80246	263	634	1

\* Spare part available



**1/2" DR. Ratchet handle-36 teeth**

<b>802415</b>	<b>l</b>		
Part no.	mm	g	pc/box
802415	240	636	1

\* Spare part available



**1/2" DR. 72teeth Ratchet handle**

<b>80249</b>	<b>l</b>		
Part no.	mm	g	pc/box
80249	245	520	1

\* Spare part available



**1/2" DR. Flexible ratchet handle**

<b>802418</b>	<b>l</b>		
Part no.	mm	g	pc/box
802418	290	798	1
802418L	427	1076	1

\* Spare part available



**1/2" DR. Ratchet handle-24 teeth**

<b>802411</b>	<b>l</b>		
Part no.	mm	g	pc/box
802411	260	832	1

\* Spare part available



**1/2" DR. Gearless ratchet handle**

<b>802421</b>	<b>l</b>		
Part no.	mm	g	pc/box
802421	240	624	1



**1/2" DR. Square hole ratchet handle**

<b>802412</b>	<b>l</b>		
Part no.	mm	g	pc/box
802412	270	558	1

802412D(driver part)

\* 1/2" Square driver is not included in ratchet handle, it's a optional item.



**1/2" DR. Sliding T handle**

<b>8034</b>	<b>l</b>		
Part no.	mm	g	pc/box
8034250	250-10"	379	10
8034300	300-12"	445	10

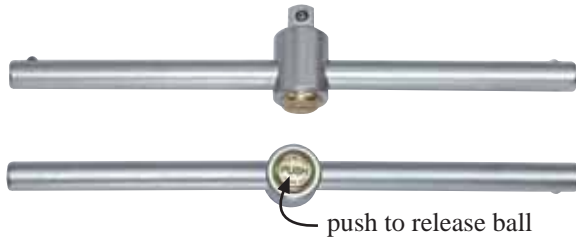

**1/2" DR. Locking sliding T handle**

<b>8034250L</b>	<b>l</b>		
Part no.	mm	g	pc/box
8034250L	250-10"	357	10



**1/2" DR. Wobble extension**

<b>8044..W</b>	<b>l</b>		
Part no.	mm	g	pc/box
8044050W	50-2"	92	10
8044125W	125-5"	185	10
8044200W	200-8"	280	10
8044250W	250-10"	346	5



**1/2" DR. Extension**

<b>8044</b>	<b>l</b>		
Part no.	mm	g	pc/box
8044050	50-2"	101	10
8044075	75-3"	141	10
8044125	125-5"	225	10
8044250	250-10"	438	5
8044380	380-15"	626	5
8044500	500-20"	806	5



**1/2" DR. Universal joint**

<b>80541</b>	<b>l</b>		
Part no.	mm	g	pc/box
80541	70	149	10



**1/2" DR. Universal & Extension**

<b>80454300</b>	<b>l</b>		
Part no.	mm	g	pc/box
80454300	300mm-12"	647	5



**1/2" DR. Extension-Thin**

<b>8044..R</b>	<b>l</b>		
Part no.	mm	g	pc/box
8044075R	75-3"	128	10
8044125R	125-5"	192	10
8044250R	250-10"	171	5



**1/2" DR. Universal & Extension**

<b>80454430</b>	<b>l</b>		
Part no.	mm	g	pc/box
80454430	430mm-17"	1042	5





**1/2" DR. Universal socket**

**80545**

Part no.	Socket	mm	g	pc/box
8054513	13	63	131	10
8054514	14	63	136	10
8054515	15	63	136	10
8054517	17	63	137	10
8054519	19	63	151	10
8054521	21	63	151	10
8054522	22	63	155	10
8054524	24	63	168	10
805451.2	1/2"	63	130	10
805459.16	9/16"	63	135	10
805455.8	5/8"	63	136	10
8054511.16	11/16"	63	137	10
805453.4	3/4"	63	151	10
8054513.16	13/16"	63	151	10
805457.8	7/8"	63	153	10
8054515.16	15/16"	63	167	10



**1/2" DR. Universal deep socket**

**80545108**

Part no.	Socket	mm	g	pc/box
8054510813	13	108	172	10
8054510814	14	108	179	10
8054510815	15	108	186	10
8054510817	17	108	201	10
8054510819	19	108	222	10
8054510821	21	108	255	10
8054510822	22	108	266	10
8054510824	24	108	283	10

**80545108**

Part no.	Socket	mm	g	pc/box
805451081.2	1/2"	108	173	10
805451089.16	9/16"	108	175	10
805451085.8	5/8"	108	179	10
8054510811.16	11/16"	108	192	10
805451083.4	3/4"	108	216	10
8054510813.16	13/16"	108	259	10
805451087.8	7/8"	108	266	10
8054510815.16	15/16"	108	283	10



**1/2" DR. Star universal socket**

**80546**

Part no.	Socket	mm	g	pc/box
8054608	E8	65	124	10
8054610	E10	65	124	10
8054611	E11	65	125	10
8054612	E12	65	127	10
8054614	E14	65	127	10
8054616	E16	65	133	10
8054618	E18	65	133	10
8054620	E20	65	177	10
8054624	E24	65	177	10



**Adaptor for 1/2" DR. Extension**

**806**

Part no.	Size	mm	g	pc/box
80634	3/8"(F) x 1/2"(M)	46	70	10



**1/2" DR. Spark plug socket**

<b>8074</b>		<i>l</i>		
Part no.	size	mm	g	pc/box
807416	16 mm	65	92	10
807418	18 mm	65	133	10
807420.6	20.6 mm	65	156	10



**1/2" Bit adaptor**

<b>809</b>		<i>l</i>		
Part no.	size	mm	g	pc/box
8095430	5/16"Hex-1/2"Sq.	30	30	10



**1/2" DR. Magnetic spark plug socket**

<b>8074..M</b>		<i>l</i>		
Part no.	size	mm	g	pc/box
807416M	16 mm	70	83	10
807418M	18 mm	70	135	10
807420.6M	20.6 mm	70	153	10



**1/2" DR. Bit holder**

<b>8104</b>		<i>l</i>		
Part no.	size	mm	g	pc/box
81042	1/2"(F) x 1/4"(F)	38	53	10
81045	1/2"(F) x 5/16"(F)	38	57	10
81047	1/2"(F) x 10mm(F)	38	57	10
810414	1/2"(F) x 14mm(F)	38	90	10



**1/2" DR. Locking extension**

<b>8084</b>	<i>l</i>		
Part no.	mm	g	pc/box
808405	125-5"	227	10
808410	250-10"	408	5
808415	375-15"	504	5
808420	500-20"	806	5



**1/2" L handle**

<b>8154</b>		<i>l</i>		
Part no.	size	mm	g	pc/box
8154260	1/2"DR.	260	241	5



**1/2" DR. Adaptor**

<b>8094</b>		<i>l</i>		
Part no.	size	mm	g	pc/box
80943	1/2"(F) x 3/8"(M)	46	65	10
80946	1/2"(F) x 3/4"(M)	46	163	10



**1/2" DR. Plastic hanger**

<b>8164</b>		<i>l</i>		
Part no.	size	mm	g	pc/box
8164	1/2"DR.	66	5	100



**1/2" DR. Socket rail**

<b>8194..</b>		<i>l</i>		
Part no.	PCS	mm	g	pc/box
819405	5	160	27	10
819409	9	260	44	10
819420	20	560	144	10



**1/2" DR. Ratchet handle (36 teeth)**

<b>802433</b>		<i>l</i>	
Part no.	Packing	mm	g
802433	20/15.3/16.3/0.5'	330	765

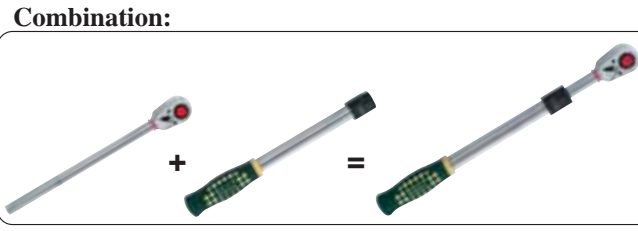

\* Spare part available



**1/2" DR. Speed T handle**

<b>8194T</b>	<i>l</i>		
Part no.	mm	g	pc/box
8194T	300	686	10



**1/2" DR. Sliding T handle**

<b>803A4300</b>		<i>l</i>	
Part no.	Packing	mm	g
803A4300	50/28.5/29.5/0.8'	300	570

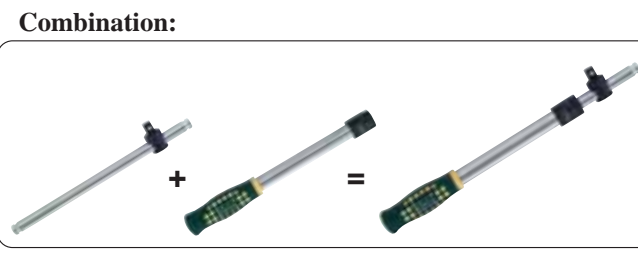

**1/2" DR. Adjustable handle (turn-lock design)**

<b>8334300</b>		<i>l</i>	
Part no.	Packing	mm	g
8334300	24/11.9/12.9/0.58'	310	496



**1/2" DR. L handle**

<b>815A4315</b>		<i>l</i>	
Part no.	Packing	mm	g
815A4315	50/27.3/28.3/0.82'	315	546

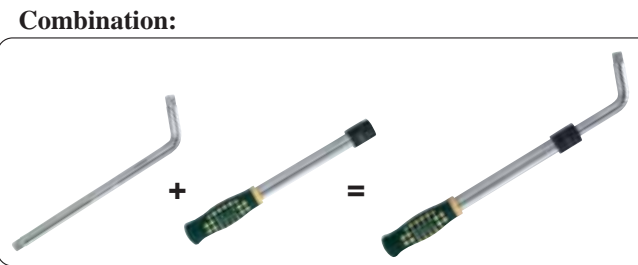



**14pc 3/4" Socket set (MM)**

<b>6141</b>			
Part no.	Socket	1/12.0/13.0/0.46'	12kg
569 22...50	Content: 3/4"DR. 10- 12pt. Flank socket 22; 24; 27; 30; 32; 36; 38; 41; 46; 50 mm		
8026500	1- Ratchet handle 500mmL		
8036450	1- Sliding T handle 450mmL		
8046 100...200	2- Extension bar 100; 200mmL		

<b>6141-5</b>			
Part no.	Socket	1/12.0/13.0/0.46'	12kg
Changed Items 565 22...50	Content: 3/4"DR. 10- 6pt. Flank socket 22; 24; 27; 30; 32; 36; 38; 41; 46; 50 mm		

**14pc 3/4" Socket set (SAE)**

<b>6141S</b>			
Part no.	Socket	1/12.0/13.0/0.46'	12kg
Changed Items 569 7.8...2	Content: 3/4"DR. 10- 12pt. Flank socket 7/8"; 15/16"; 1"; 1-1/8"; 1-1/4"; 1-7/16"; 1-1/2"; 1-5/8"; 1-3/4"; 2"		



**14pc 3/4" Socket set (MM)**

<b>6141B</b>			
Part no.	Socket	2/24.0/25.0/1.4'	12kg
569 22...50	Content: 3/4"DR. 10- 12pt. Flank socket 22; 24; 27; 30; 32; 36; 38; 41; 46; 50 mm		
8026500	1- Ratchet handle 500mmL		
8036450	1- Sliding T handle 450mmL		
8046 100...200	2- Extension bar 100; 200mmL		

<b>6141B-5</b>			
Part no.	Socket	2/24.0/25.0/1.4'	12kg
Changed Items 565 22...50	Content: 3/4"DR. 10- 6pt. Flank socket 22; 24; 27; 30; 32; 36; 38; 41; 46; 50 mm		

**14pc 3/4" Socket set (SAE)**

<b>6141SB</b>			
Part no.	Socket	2/24.0/25.0/1.4'	12kg
Changed Items 569 7.8...2	Content: 3/4"DR. 10- 12pt. Flank socket 7/8"; 15/16"; 1"; 1-1/8"; 1-1/4"; 1-7/16"; 1-1/2"; 1-5/8"; 1-3/4"; 2"		

**20pc 3/4" Socket set (MM)**

<b>6201</b>			
Part no.	Socket	1/13.5/14.5/0.46'	13.5kg
569 19...50	Content: 3/4"DR. 16- 12pt. Flank socket 19; 21; 22; 23; 24; 26; 27; 29; 30; 32; 35; 36; 38; 41; 46; 50 mm		
8026500	1- Ratchet handle 500mmL		
8036450	1- Sliding T handle 450mmL		
8046 100...200	2- Extension bar 100; 200mmL		

<b>6201-5</b>			
Part no.	Socket	1/13.5/14.5/0.46'	13.5kg
Changed Items 565 19...50	Content: 3/4"DR. 16- 6pt. Flank socket 19; 21; 22; 23; 24; 26; 27; 29; 30; 32; 35; 36; 38; 41; 46; 50 mm		

**20pc 3/4" Socket set (SAE)**

<b>6201S</b>			
Part no.	Socket	1/13.5/14.5/0.46'	13.5kg
Changed Items 569 7.8...2	Content: 3/4"DR. 16- 12pt. Flank socket 7/8"; 15/16"; 1"; 1-1/16; 1-1/8"; 1-3/16"; 1-1/4"; 1-5/16"; 1-3/8"; 1-7/16"; 1-1/2"; 1-5/8"; 1-3/4"; 1-13/16"; 1-7/8"; 2"		

**20pc 3/4" Socket set (MM)**

<b>6201B</b>			
Part no.	Socket	2/27.0/28.0/1.4'	13.5kg
569 19...50	Content: 3/4"DR. 16- 12pt. Flank socket 19; 21; 22; 23; 24; 26; 27; 29; 30; 32; 35; 36; 38; 41; 46; 50 mm		
8026500	1- Ratchet handle 500mmL		
8036450	1- Sliding T handle 450mmL		
8046 100...200	2- Extension bar 100; 200mmL		

<b>6201B-5</b>			
Part no.	Socket	2/27.0/28.0/1.4'	13.5kg
Changed Items 565 19...50	Content: 3/4"DR. 16- 6pt. Flank socket 19; 21; 22; 23; 24; 26; 27; 29; 30; 32; 35; 36; 38; 41; 46; 50 mm		

**20pc 3/4" Socket set (SAE)**

<b>6201SB</b>			
Part no.	Socket	2/27.0/28.0/1.4'	13.5kg
Changed Items 569 7.8...2	Content: 3/4"DR. 16- 12pt. Flank socket 7/8"; 15/16"; 1"; 1-1/16; 1-1/8"; 1-3/16"; 1-1/4"; 1-5/16"; 1-3/8"; 1-7/16"; 1-1/2"; 1-5/8"; 1-3/4"; 1-13/16"; 1-7/8"; 2"		





**21pc 3/4" Socket set (MM)**

<b>6212</b>			
Part no.	Socket	2/27.0/28.0/1.4'	13.5kg
569 19...50	Content: 3/4"DR. 16- 12pt. Flank socket 19; 21; 22; 23; 24; 26; 27; 29; 30; 32; 35; 36; 38; 41; 46; 50 mm		
8026500	1- Ratchet handle 500mmL		
8036450	1- Sliding T handle 450mmL		
8046 100...400	3- Extension bar 100; 200;400mmL		

<b>6212-5</b>			
Part no.	Socket	2/27.0/28.0/1.4'	13.5kg
Changed Items 565 19...50	Content: 3/4"DR. 16- 6pt. Flank socket 19; 21; 22; 23; 24; 26; 27; 29; 30; 32; 35; 36; 38; 41; 46; 50 mm		

**21pc 3/4" Socket set (SAE)**

<b>6212S</b>			
Part no.	Socket	2/27.0/28.0/1.4'	13.5kg
Changed Items 569 7.8...2	Content: 3/4"DR. 16- 12pt. Flank socket 7/8"; 15/16"; 1"; 1-1/16"; 1-1/8"; 1-3/16"; 1-1/4"; 1-5/16"; 1-3/8"; 1-7/16"; 1-1/2"; 1-5/8"; 1-3/4"; 1-13/16"; 1-7/8"; 2"		



**6pc 3/4" Accessory set**

<b>6061</b>		
Part no.	2/14.4/15.4/0.86'	7.2kg
8016800B	Content: 3/4"DR. 1-800mm Telescope adjustable handle	
8026150	1-150mm 40 teeth ratchet head	
8016135	1-135mm Universal flex head	
8046100	1-100mm Extension bar	
80361	1-Adaptor for sliding T handle	
80968-6061	1-Adaptor 3/4"(F)x1"(M)	





### 3/4"DR. 6pt. Flank socket

### 3/4"DR. 12pt. Flank socket

<b>565</b>		<i>l</i>		
Part no.	size	mm	g	pc/box
56519	19	36	180	2
56520	20	36	180	2
56521	21	36	224	2
56522	22	36	226	2
56523	23	36	230	2
56524	24	36	235	2
56525	25	36	243	2
56526	26	36	248	2
56527	27	36	254	2
56528	28	38	258	2
56529	29	38	261	2
56530	30	38	283	2
56532	32	38	313	2
56533	33	38	344	2
56535	35	42	402	2
56536	36	42	439	2
56538	38	45	499	2
56540	40	45	500	2
56541	41	45	594	2
56542	42	45	580	2
56546	46	48	713	2
56550	50	48	878	2
56554	54	48	900	2
56555	55	48	994	2
56560	60	48	1115	2



<b>569</b>		<i>l</i>		
Part no.	size	mm	g	pc/box
56919	19	36	176	2
56921	21	36	179	2
56922	22	36	222	2
56923	23	36	227	2
56924	24	36	230	2
56925	25	36	238	2
56926	26	36	249	2
56927	27	36	249	2
56928	28	38	259	2
56929	29	38	268	2
56930	30	38	280	2
56931	31	38	290	2
56932	32	38	294	2
56933	33	38	330	2
56934	34	42	350	2
56935	35	42	394	2
56936	36	42	420	2
56938	38	45	481	2
56941	41	45	540	2
56946	46	48	677	2
56950	50	48	814	2
56955	55	48	949	2
56956	56	48	1000	2
56960	60	48	1013	2
56965	65	48	1100	2

5693.4	3/4"	36	184	2
56913.16	13/16"	36	202	2
5697.8	7/8"	36	219	2
56915.16	15/16"	36	232	2
5691.0	1"	36	225	2
5691.1.16	1-1/16"	36	231	2
5691.1.8	1-1/8"	38	258	2
5691.3.16	1-3/16"	38	280	2
5691.1.4	1-1/4"	38	304	2

<b>569</b>		<i>l</i>		
Part no.	size	mm	g	pc/box
5691.5.16	1-5/16"	38	329	2
5691.3.8	1-3/8"	42	386	2
5691.7.16	1-7/16"	42	424	2
5691.1.2	1-1/2"	45	476	2
5691.9.16	1-9/16"	45	501	2
5691.5.8	1-5/8"	45	559	2
5691.11.16	1-11/16"	45	633	2
5691.3.4	1-3/4"	48	650	2
5691.13.16	1-13/16"	48	700	2
5691.7.8	1-7/8"	48	730	2
5691.15.16	1-15/16"	48	750	2
5692.0	2"	48	800	2
5692.1.16	2-1/16"	48	852	2
5692.1.8	2-1/8"	48	894	2
5692.3.16	2-3/16"	48	901	2
5692.1.4	2-1/4"	48	924	2
5692.5.16	2-5/16"	50	1049	2
5692.3.8	2-3/8"	50	1086	2
5692.7.16	2-7/16"	50	1127	2
5692.1.2	2-1/2"	50	1162	2



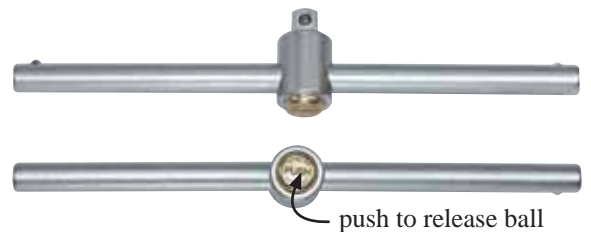

**3/4"DR. Sliding T handle**

<b>8036</b>	<i>l</i>		
Part no.	mm	g	pc/box
8036450	450-18"	1388	10
8036500	500-20"	1514	10





**3/4"DR. Locking sliding T handle**

<b>8036450L</b>	<i>l</i>		
Part no.	mm	g	pc/box
8036450L	450-18"	1350	10





**3/4"DR. Swivel handle**

<b>8016</b>	<i>l</i>		
Part no.	mm	g	pc/box
8016475	475-19"	1900	5

\* Spare part available





**3/4"DR. Extension**

<b>8046</b>	<i>l</i>		
Part no.	mm	g	pc/box
8046100	100-4"	400	50
8046125	125-5"	500	30
8046200	200-8"	700	30
8046400	400-16"	1400	15



**3/4"DR. Ratchet handle**



<b>8026</b>	<i>l</i>		
Part no.	mm	g	pc/box
8026500	500-20"	1970	10

\* Spare part available







**3/4"DR. Universal joint**

<b>8056</b>	<i>l</i>		
Part no.	mm	g	pc/box
80561	109	625	2





**3/4"DR. L handle**

<b>8156</b>	<i>l</i>		
Part no.	mm	g	pc/box
8156330	330	1500	10
8156450	450	1990	10





**3/4"DR. Locking extension**

<b>8086</b>	<i>l</i>		
Part no.	mm	g	pc/box
8086100	100-4"	460	50
8086200	200-8"	809	30
8086400	400-16"	1598	15





**3/4"DR. Adaptor**

<b>8096</b>		<i>l</i>		
Part no.	size	mm	g	pc/box
80964	3/4"(F)x1/2"(M)	50	308	5
80968	3/4"(F)x1"(M)	60	407	2





**14pc 1" Socket set (MM)**



<b>8141</b>			
Part no.	Socket	1/27.6/28.6/0.78'	27.6kg
	Content: 1"DR.		
589 36...80	10- 12pt. Flank socket 36; 41; 46; 50; 55; 60; 65; 70; 75; 80 mm		
80281	1- Ratchet head (head part of 8028650)		
80381	1- Adaptor for sliding T handle (adaptor of 8038550)		
8008550	1- 550mmL handle bar		
8048 200...400	2-Extension bar 200; 400mmL		





**21pc 1" Socket set (MM)**

<b>8211</b>			
Part no.	Socket	1/43.5/45.0/1.1'	43.5kg
	Content: 1"DR.		
589 36...80	10- 12pt. Flank socket 36; 38; 41; 46; 50; 54; 55; 58; 60; 63; 65; 67; 70; 71; 75; 77; 80 mm		
80281	1- Ratchet head (head part of 8028650)		
80381	1- Adaptor for sliding T handle (adaptor of 8038550)		
8008550	1- 550mmL handle bar		
8048 200...400	2-Extension bar 200; 400mmL		

**14pc 1" Socket set (SAE)**

<b>8141S</b>			
Part no.	Socket	1/27.6/28.6/0.78'	27.6kg
Changed Items	Content: 1"DR.		
589 1.7.16...3.1.8	10- 12pt. Flank socket 1-7/16"; 1-1/2"; 1-11/16"; 1-7/8"; 2"; 2-1/4"; 2-3/8"; 2-5/8"; 2-15/16"; 3-1/8"		

**21pc 1" Socket set (SAE)**

<b>8211S</b>			
Part no.	Socket	1/43.5/45.0/1.1'	43.5kg
Changed Items	Content: 1"DR.		
589 1.7.16...3.1.8	17- 12pt. Flank socket 1-7/16"; 1-1/2"; 1-5/8"; 1-11/16"; 1-3/4"; 1-13/16"; 1-7/8"; 2"; 2-1/8"; 2-3/16"; 2-1/4"; 2-3/8"; 2-1/2"; 2-5/8"; 2-3/4"; 2-15/16"; 3-1/8"		





**1"DR. 12pt. Flank socket**

<b>589</b>		<i>l</i>		
Part no.	size	mm	g	pc/box
58935	35	61	412	2
58936	36	65	468	2
58938	38	65	495	2
58941	41	70	601	2
58946	46	75	862	2
58950	50	75	1025	2
58954	54	80	1100	2
58955	55	80	1204	2
58958	58	80	1299	2
58960	60	84	1401	2
58963	63	87	1616	2
58965	65	87	1632	2
58967	67	90	1654	1
58970	70	93	2048	1
58971	71	93	2100	1
58975	75	97	2278	1
58977	77	103	2302	1
58980	80	103	2390	1
58985	85	105	2578	1
5891.3.8	1-3/8"	61	412	2
5891.7.16	1-7/16"	65	468	2
5891.1.2	1-1/2"	65	495	2
5891.5.8	1-5/8"	70	601	2
5891.11.16	1-11/16"	70	710	2
5891.3.4	1-3/4"	75	780	2
5891.13.16	1-13/16"	75	862	2
5891.7.8	1-7/8"	75	1000	2
5892.0	2"	75	1045	2
5892.1.16	2-1/16"	80	1100	2
5892.1.8	2-1/8"	80	1150	2
5892.3.16	2-3/16"	80	1204	2
5892.1.4	2-1/4"	80	1238	2
5892.5.16	2-5/16"	80	1340	2
5892.3.8	2-3/8"	84	1368	2
5892.7.16	2-7/16"	87	1530	2

<b>589</b>		<i>l</i>		
Part no.	size	mm	g	pc/box
5892.1.2	2-1/2"	87	1550	2
5892.9.16	2-9/16"	90	1690	1
5892.5.8	2-5/8"	90	1800	1
5892.11.16	2-11/16"	93	1950	1
5892.3.4	2-3/4"	93	2250	1
5892.13.16	2-13/16"	93	2350	1
5892.7.8	2-7/8"	97	2210	1
5892.15.16	2-15/16"	97	2330	1
5893.0	3"	103	2390	1
5893.1.8	3-1/8"	103	2578	1



**1"DR. Swivel handle**

<b>8018</b>	<i>l</i>		
Part no.	mm	g	pc/box
8018650	650-26"	4122	5

\* Spare part available



**1"DR. Ratchet handle**

<b>8028</b>	<i>l</i>		
Part no.	mm	g	pc/box
8028650	650-26"	4424	5

\* Spare part available



**1"DR. Sliding T handle**

<b>8038</b>	<i>l</i>		
Part no.	mm	g	pc/box
8038550	550-22"	3288	5



**1"DR. Extension**

<b>8048</b>	<i>l</i>		
Part no.	mm	g	pc/box
8048200	200-8"	1330	2
8048400	400-16"	2290	1



**1"DR. Adaptor**

<b>8098</b>	<i>l</i>			
Part no.	size	mm	g	pc/box
80986	1"(F)x3/4"(M)	70	964	2



**1"DR. Universal joint**

<b>8058</b>	<i>l</i>		
Part no.	mm	g	pc/box
80581	143	1237	2



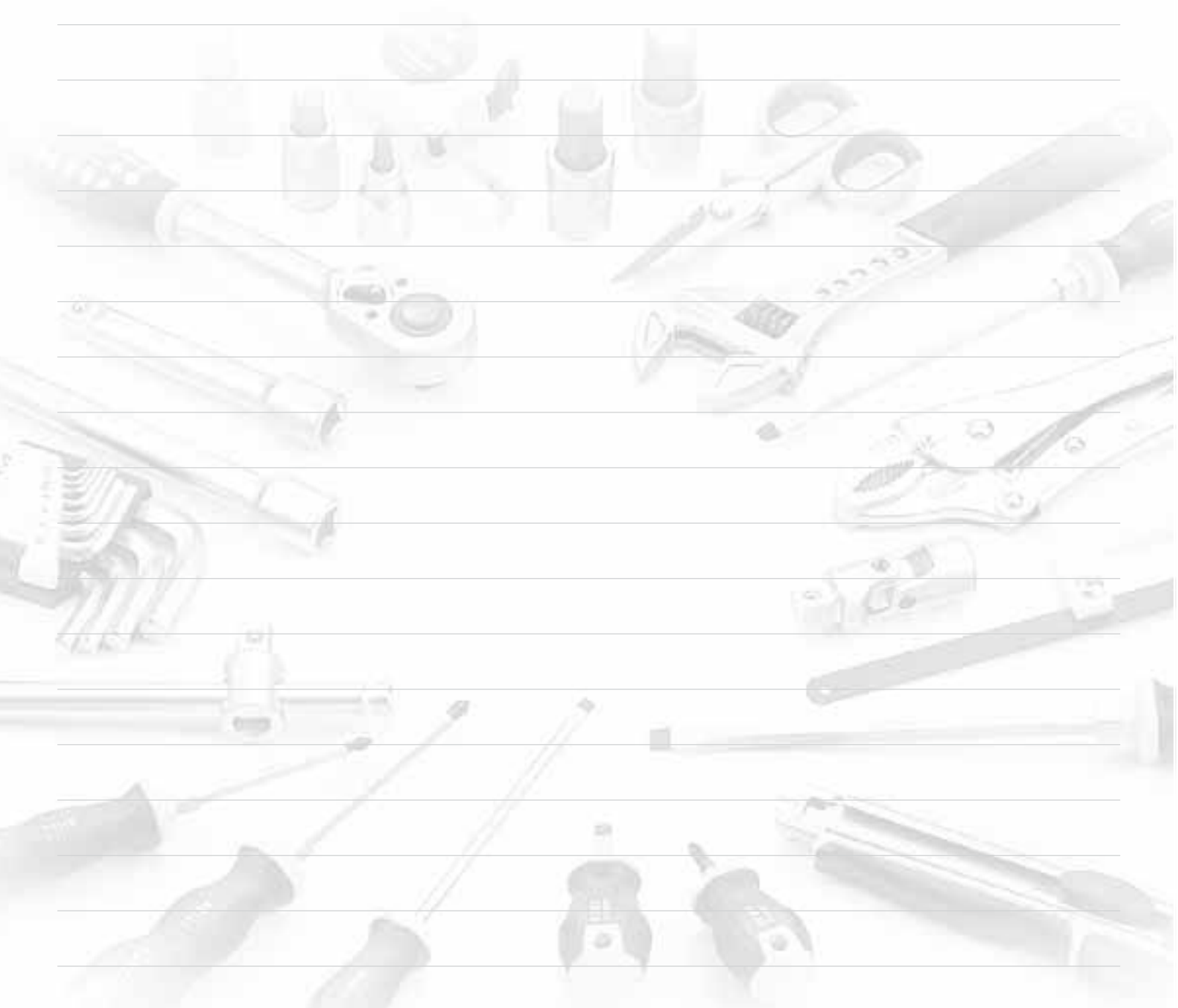

**1"DR. L handle**

<b>8158650</b>	<i>l</i>		
Part no.	mm	g	pc/box
8158650	650	4612	4







**13pc 1/4"DR. 6pt. Flank impact socket set**



<b>K2139</b>			
Part no.	Socket	24/21.1/22.2/1.5'	880g
425 04...13	Content: 1/4"DR. 12-6pt. Flank impact socket (MM) 4; 4.5; 5; 5.5; 6; 7; 8; 9; 10; 11; 12; 13 mm		
82421	1-Palm impact ratchet wrench		

**13pc 1/4"DR. 6pt. Flank impact socket set**



<b>K2139-2</b>			
Part no.	Socket	24/23.2/24.2/1.5'	965g
425 04...13	Content: 1/4"DR. 12-6pt. Flank impact socket (MM) 4; 4.5; 5; 5.5; 6; 7; 8; 9; 10; 11; 12; 13 mm		
82422	1-Stubby impact ratchet wrench		



**23pc 1/4"DR. 6pt. Flank impact socket set (SAE&MM)**

<b>K2231</b>			
Part no.	Socket	24/24.7/25.7/1.5'	1030g
425 04...13	Content: 1/4"DR. 12-6pt. Flank impact socket (MM) 4; 4.5; 5; 5.5; 6; 7; 8; 9; 10; 11; 12; 13 mm		
425 5.32...1.2	10-6pt. Flank impact socket (SAE) 5/32"; 3/16"; 7/32"; 1/4"; 9/32"; 5/16"; 11/32"; 3/8"; 7/16"; 1/2"		
82421	1-Palm impact ratchet wrench		



**23pc 1/4"DR. 6pt. Flank impact socket set (SAE&MM)**

<b>K2231-2</b>			
Part no.	Socket	24/26.9/27.9/1.5'	1120g
425 04...13	Content: 1/4"DR. 12-6pt. Flank impact socket (MM) 4; 4.5; 5; 5.5; 6; 7; 8; 9; 10; 11; 12; 13 mm		
425 5.32...1.2	10-6pt. Flank impact socket (SAE) 5/32"; 3/16"; 7/32"; 1/4"; 9/32"; 5/16"; 11/32"; 3/8"; 7/16"; 1/2"		
82422	1-Stubby impact ratchet wrench		





**1/4" DR. Palm impact ratchet wrench**



<b>82421</b>	<b>l</b>		
Part no.	mm	g	pc/box
82421	125mm-4.9"	450	1

**Specifications :**

Square Drive.....	1/4"
Free Speed (R.P.M.).....	250
Working Torque Range (Ft/Lbs) / (N-M).....	0-20/0-27
Max. Torque (Ft/Lbs)/(N-M).....	25/33
Air Pressure (PSI).....	90
AIR Inlet (P.T.).....	1/4"
Air Consumption (C.F.M.).....	2.4
Sound Pressure Level (dBA).....	79.9



**1/4" DR. Air impact hammer drill**



<b>82721</b>	<b>l</b>		
Part no.	mm	g	pc/box
82721	140mm-5.5"	700	1

**Specifications :**

Drill Capacity (mm).....	6.35
Free Speed (R.P.M.).....	3000
Max. Torque (Ft/Lbs) / (N-M).....	30 / 40.5
Air Pressure (PSI).....	90
AIR Inlet (P.T.).....	1/4"
Air Consumption (C.F.M.).....	2
Reversible.....	No



**1/4" DR. Stubby impact ratchet wrench**





<b>82422</b>	<b>l</b>		
Part no.	mm	g	pc/box
82422	165mm-6.5"	500	1

**Specifications :**





Square Drive.....	1/4"
Free Speed (R.P.M.).....	240
Working Torque Range (Ft/Lbs) / (N-M).....	30/40.5 / 5-20/7-27
Max. Torque (Ft/Lbs) / (N-M).....	90
Air Pressure (PSI).....	1/4"
AIR Inlet (P.T.).....	2.5



**1/4"DR. 6pt. Flank impact socket**

<b>425</b>				
Part no.	Socket	mm	g	pc/box
42504	4	23	10	50
425045	4.5	23	13	50
42505	5	23	13	50
425055	5.5	23	13	50
42506	6	23	13	50
42507	7	23	14	50
42508	8	23	14	50
42509	9	23	18	50
42510	10	23	24	50
42511	11	23	24	50
42512	12	23	27	50
42513	13	23	32	50
42514	14	23	36	50
4255.32	5/32"	23	10	50
4253.16	3/16"	23	13	50
4257.32	7/32"	23	13	50
4251.4	1/4"	23	13	50
4259.32	9/32"	23	13	50
4255.16	5/16"	23	14	50
42511.32	11/32"	23	14	50
4253.8	3/8"	23	18	50
4257.16	7/16"	23	24	50
4251.2	1/2"	23	32	50
4259.16	9/16"	23	36	50

**1/4"DR. Star impact socket**

<b>426</b>				
Part no.	Socket	mm	g	pc/box
42604	E4	23	12	50
42605	E5	23	12	50
42606	E6	23	12	50
42607	E7	23	12	50
42608	E8	23	14	50
42610	E10	23	16	50



**5pc Star impact socket set**

<b>3063</b>			
Part no.	Socket	80/24.0/25.0/1.5'	300g
436 06...08 446 10...14	Content: 3/8"DR. & 1/2" DR. 5-Impact star socket 3/8": E6; E8; 1/2": E10; E12; E14		



**8pc 3/8" Impact socket set (MM)**

<b>3083</b>			
Part no.	Socket	40/25.0/26.0/0.6'	625g
435 08...19	Content: 3/8"DR. 8-Impact socket 8; 10; 11; 12; 13; 14; 17; 19 mm		

<b>3083S</b>			
Part no.	Socket	40/25.0/26.0/0.6'	625g
435 5.16...3.4	Content: 3/8"DR. 8-Impact socket 5/16"; 3/8"; 7/16"; 1/2"; 9/16"; 5/8"; 11/16"; 3/4"		



**8pc 3/8" Impact deep socket set (MM)**

<b>3084</b>			
Part no.	Socket	20/23.0/24.0/0.5'	1150g
43563 08...19	Content: 3/8"DR. 8-Impact deep socket 8; 10; 11; 12; 13; 14; 17; 19 mm		

**8pc 3/8" Impact deep socket set (SAE)**

<b>3084S</b>			
Part no.	Socket	20/23.0/24.0/0.5'	1150g
43563 5.16...3.4	Content: 3/8"DR. 8-Impact deep socket 5/16"; 3/8"; 7/16"; 1/2"; 9/16"; 5/8"; 11/16"; 3/4"		



**13pc Impact wrench socket set**

<b>K3133</b>			
Part no.	Socket	24/24.7/25.7/1.5'	1030g
435 06...19 82432 8043075MPB	Content: 3/8"DR. 11- 6pt. Flank impact socket 6; 7; 8; 10; 11; 12; 13; 14; 15; 17; 19 mm 1- Palm impact ratchet wrench 1- Impact extension (ball type)		



**13pc Impact wrench socket set**

**K3133-3**

Part no.	Socket	24/26.9/27.9/1.5'	1120g
435 06...19	Content: 3/8"DR. 11-6pt. Flank impact socket 6; 7; 8; 10; 11; 12; 13; 14; 15; 17; 19 mm		
82433	1-Stubby impact ratchet wrench		
8043075MPB	1-Impact extension (ball type)		



**3/8" Hex impact socket bit(one-piece)**

<b>23452</b>				
Part no.	Socket	mm	g	pc/box
2345204	4	52	35	10
2345205	5	52	38	10
2345206	6	52	41	10
2345207	7	52	43	10
2345208	8	52	47	10
2345210	10	52	57	10
2345212	12	52	66	10







**3/8" DR. Star impact socket bit(one-piece)**

<b>23652</b>				
Part no.	Socket	mm	g	pc/box
2365220	T20	52	25	10
2365225	T25	52	35	10
2365227	T27	52	38	10
2365230	T30	52	38	10
2365240	T40	52	40	10
2365245	T45	52	45	10
2365250	T50	52	50	10







**3/8" DR. 6pt. Flank impact socket**

<b>435</b>				
Part no.	Socket	mm	g	pc/box
43506	6	32	30	20
43507	7	32	31	20
43508	8	32	32	20
43509	9	32	33	20
43510	10	32	34	20
43511	11	32	36	20
43512	12	32	38	20
43513	13	32	40	20
43514	14	32	51	20
43515	15	32	54	20
43516	16	32	55	20
43517	17	32	55	20
43518	18	32	55	20
43519	19	32	59	20
43520	20	32	60	20
43521	21	32	51	20
43522	22	32	52	20
4355.16	5/16"	32	30	20
4353.8	3/8"	32	31	20
4357.16	7/16"	32	36	20
4351.2	1/2"	32	38	20
4359.16	9/16"	32	51	20
4355.8	5/8"	32	55	20
43511.16	11/16"	32	55	20
4353.4	3/4"	32	59	20
43513.16	13/16"	32	61	20
4357.8	7/8"	32	62	20



**3/8" DR. 6pt. Flank impact deep socket**

<b>43563</b>				
Part no.	Socket	mm	g	pc/box
4356308	8	63	48	20
4356310	10	63	58	20
4356311	11	63	64	20
4356312	12	63	80	20
4356313	13	63	85	20
4356314	14	63	92	20
4356315	15	63	110	20
4356316	16	63	108	20
4356317	17	63	108	20
4356318	18	63	129	20
4356319	19	63	138	20
435635.16	5/16"	63	48	20
435633.8	3/8"	63	58	20
435637.16	7/16"	63	64	20
435631.2	1/2"	63	80	20
435639.16	9/16"	63	92	20
435635.8	5/8"	63	110	20
4356311.16	11/16"	63	108	20
435633.4	3/4"	63	138	20





**3/8" DR. Star impact socket**

**436**

Part no.	Socket	mm	g	pc/box
43604	E4	28	31	20
43605	E5	28	31	20
43606	E6	28	31	20
43607	E7	28	31	20
43608	E8	28	32	20
43610	E10	28	32	20
43611	E11	28	32	20
43612	E12	28	34	20
43614	E14	28	37	20



**3/8"DR. Palm impact ratchet wrench**

**82432**

Part no.	mm	g	pc/box
82432	125mm-4.9"	450	1

**Specifications :**

Square Drive..... 3/8"  
 Free Speed (R.P.M.)..... 250  
 Working Torque Range (Ft/Lbs) / (N-M)..... 0-20/0-27  
 Max. Torque (Ft/Lbs) / (N-M)..... 25 / 33  
 Air Pressure (PSI)..... 90  
 AIR Inlet (P.T.)..... 1/4"  
 Air Consumption (C.F.M.)..... 2.4



**3/8" DR. Impact ratchet wrench**

**82431**

Part no.	mm	g	pc/box
82431	250mm-10"	1298	1

**Specifications :**

Square Drive..... 3/8"  
 Free Speed (R.P.M.)..... 160  
 Max. Torque (Ft/Lbs) / (N-M)..... 60 / 81  
 Air Pressure (PSI)..... 90  
 AIR Inlet (P.T.)..... 1/4"  
 Air Consumption (C.F.M.)..... 4



**3/8"DR. Stubby impact ratchet wrench**

**82433**

Part no.	mm	g	pc/box
82433	165mm-6.5"	500	1

**Specifications :**

Square Drive..... 3/8"  
 Free Speed (R.P.M.)..... 240  
 Working Torque Range (Ft/Lbs) / (N-M)..... 5-20 / 7-27  
 Max. Torque (Ft/Lbs) / (N-M)..... 30 / 40.5  
 Air Pressure (PSI)..... 90  
 AIR Inlet (P.T.)..... 1/4"  
 Air Consumption (C.F.M.)..... 2.5  
 Sound Pressure Level (dBA)..... 79.9



**3/8" DR. Super duty impact ratchet wrench**

<b>82434</b>	<b>l</b>		
Part no.	mm	g	pc/box
82434	260mm-10.3"	1130	1

**Specifications :**

Square Drive..... 3/8"  
 Free Speed (R.P.M.)..... 160  
 Working Torque Range (Ft/Lbs) / (N-M)..... 10-55/14-75  
 Max. Torque (Ft/Lbs) / (N-M)..... 60 / 81  
 Air Pressure (PSI)..... 90  
 AIR Inlet (P.T.)..... 1/4"  
 Air Consumption (C.F.M.)..... 3



**3/8" DR. Mini composite impact wrench**

<b>82532</b>	<b>l</b>		
Part no.	mm	g	pc/box
82532	154mm-6"	1200	1

**Specifications :**

Square Drive..... 3/8"  
 Free Speed (R.P.M.)..... 12500  
 Working Torque Range (Ft/Lbs) / (N-M)..... 90-260 / 120-351  
 Max. Torque (Ft/Lbs) / (N-M)..... 300 / 400  
 Air Pressure (PSI)..... 90  
 AIR Inlet (P.T.)..... 1/4"  
 Air Consumption (C.F.M.)..... 4



**3/8" DR. Mini impact wrench**

<b>82531</b>	<b>l</b>		
Part no.	mm	g	pc/box
82531	145mm-5.7"	1500	1

**Specifications :**

Square Drive..... 3/8"  
 Free Speed (R.P.M.)..... 12500  
 Working Torque Range (Ft/Lbs) / (N-M)..... 90-260 / 120-351  
 Max. Torque (Ft/Lbs) / (N-M)..... 300 / 400  
 Air Pressure (PSI)..... 90  
 AIR Inlet (P.T.)..... 1/4"  
 Air Consumption (C.F.M.)..... 4



**3/8" DR. Impact wrench**



<b>82533</b>	<b>l</b>		
Part no.	mm	g	pc/box
82533	155mm-6.1"	1320	1

**Specifications :**

Square Drive..... 3/8"  
 Free Speed (R.P.M.)..... 6200  
 Max. Torque (Ft/Lbs) / (N-M)..... 202 / 270  
 Air Pressure (PSI)..... 90  
 AIR Inlet (P.T.)..... 1/4"  
 Air Consumption (C.F.M.)..... 3



**3/8"DR. Air impact hammer drill**



<b>82731</b>	<b>l</b>		
Part no.	mm	g	pc/box
82731	165mm-6.5"	1070	1

**Specifications :**

Drill Capacity (mm).....	9.5
Free Speed (R.P.M.).....	2200
Air Pressure (PSI).....	90
AIR Inlet (P.T.).....	1/4"
Air Consumption (C.F.M.).....	2
Reversible.....	Yes



**3/8"DR. Air impact hammer drill**



<b>82732</b>	<b>l</b>		
Part no.	mm	g	pc/box
82732	183mm-7.2"	1200	1

**Specifications :**

Drill Capacity (mm).....	9.5
Free Speed (R.P.M.).....	1600
Air Pressure (PSI).....	90
AIR Inlet (P.T.).....	1/4"
Air Consumption (C.F.M.).....	2
Reversible.....	Yes



**3/8"DR. Air impact hammer drill**



<b>82733</b>	<b>l</b>		
Part no.	mm	g	pc/box
82733	210mm-8.3"	870	1

**Specifications :**

Drill Capacity (mm).....	9.5
Free Speed (R.P.M.).....	160
Air Pressure (PSI).....	90
AIR Inlet (P.T.).....	1/4"
Air Consumption (C.F.M.).....	2
Reversible.....	Yes



**3/8"DR. Air impact hammer drill**

<b>82734</b>	<b>l</b>		
Part no.	mm	g	pc/box
82734	210mm-8.3"	1400	1

**Specifications :**

Drill Capacity (mm).....	9.5
Free Speed (R.P.M.).....	1500
Air Pressure (PSI).....	90
AIR Inlet (P.T.).....	1/4"
Air Consumption (C.F.M.).....	2
Reversible.....	Yes



**3/8" DR. Impact extension (pin type)**

<b>8043..MPP</b>	<i>l</i>		
Part no.	mm	g	pc/box
8043075MPP	75-3"	76	10
8043150MPP	150-6"	145	10



**3/8" DR. Adaptor (pin type)**

<b>8093..MPP</b>		<i>l</i>		
Part no.	Size	mm	g	pc/box
80932MPP	3/8"(F)x1/4"(M)	28	50	10
80934MPP	3/8"(F)x1/2"(M)	36	46	10

**3/8" DR. Impact extension (ball type)**

<b>8043..MPB</b>	<i>l</i>		
Part no.	mm	g	pc/box
8043075MPB	75-3"	78	10
8043150MPB	150-6"	147	10



**3/8" DR. Universal joint (pin type)**

<b>80531MPP</b>	<i>l</i>		
Part no.	mm	g	pc/box
80531MPP	71	110	10

**3/8" DR. Adaptor (ball type)**

<b>8093..MPB</b>		<i>l</i>		
Part no.	Size	mm	g	pc/box
80932MPB	3/8"(F)x1/4"(M)	28	50	10
80934MPB	3/8"(F)x1/2"(M)	36	46	10



**3/8" DR. Universal joint (ball type)**

<b>80531MPB</b>	<i>l</i>		
Part no.	mm	g	pc/box
80531MPB	71	88	10

**O-ring & Pin for 3/8"DR.**

Part no.	mm	mm	g	pc/box
R1335	∅13-∅3.5		2	50
P1425		14L-∅ 2.0	2	50
R1635	∅16-∅3.5		2	50
P1625		16L-∅ 2.5	2	50



**3pc 1/2"DR. Wheel nut impact socket set**

**K4032**

Part no.	Socket	24/22.3/23.3/1.5'	930g
----------	--------	-------------------	------

44585 17C...21C  
Content: 1/2"DR.  
3-Wheel nut 6pt. flank impact socket  
17; 19; 21mm (85mmL)



**3pc 1/2"DR. Wheel nut deep impact socket set**

**K4033**

Part no.	Socket	24/33.6/34.6/1.5'	1435g
----------	--------	-------------------	-------

445150 17C...21C  
Content: 1/2"DR.  
3-Wheel nut 6pt. flank deep impact  
socket 17; 19; 21mm (150mmL)



**7pc 1/2" Impact star set**

**4073**

Part no.	Socket	20/23.0/24.0/1'	1150g
----------	--------	-----------------	-------

446 06...18  
Content: 1/2"DR.  
7-Impact star socket  
E6; E8; E10; E12; E14; E16; E18



**7pc 1/2" Hex impact socket bit set**

**4077**

Part no.	Bit	20/16.0/17.0/0.82'	800g
----------	-----	--------------------	------

244060 04...14  
Content: 1/2"DR.  
7-Hex impact socket bit (one-piece)  
4; 5; 6; 8; 10; 12; 14 mm (60mmL)





7pc 1/2" Star impact socket bit set			
<b>4078</b>			
Part no.	Bit	20/22.0/23.5/0.82'	1100g
246060 30...70	Content: 1/2"DR. 7-Star impact socket bit (one-piece) T30; T40; T45; T50; T55; T60; T70 (60mmL)		



8pc Impact adapter (pin type)		
<b>K4088</b>		
Part no.	12/41.2/42.2/1.1'	3430g
809 32MPP... 812MPP	Content: 1/2"DR. 8-Impact Adapter (pin type) 3/8"(F)x1/4"(M); 3/8"(F)x1/2"(M); 1/2"(F)x3/8"(M); 1/2"(F)x3/4"(M); 3/4"(F)x1/2"(M); 3/4"(F)x1"(M); 1"(F)x3/4"(M); 1"(F)x1-1/2"(M)	



7pc Impact adapter (ball type)		
<b>K4079</b>		
Part no.	12/22.6/23.6/1.1'	1880g
809 32MPB... 86MPB	Content: 1/2"DR. 7- Impact Adapter (ball type) 3/8"(F)x1/4"(M); 3/8"(F)x1/2"(M); 1/2"(F)x3/8"(M); 1/2"(F)x3/4"(M); 3/4"(F)x1/2"(M); 3/4"(F)x1"(M); 1"(F)x3/4"(M)	



9pc Wheel nut impact socket set			
<b>K4099</b>			
Part no.	Socket	6/15.3/16.3/0.8'	2543g
44585 14C...27C	Content: 1/2"DR. 9- Wheel nut 6pt. flank impact socket (85mmL) 14; 15; 17; 19; 21; 22; 23; 24; 27 mm		



**10pc 1/2" Impact deep socket set (MM)**

<b>4107</b>			
Part no.	Socket	10/16.9/27.9/0.7'	2690g
44585 11...24	Content: 1/2"DR. 10-Impact deep socket 11; 12; 13; 14; 16; 17; 19; 21; 22; 24 mm		

**10pc 1/2" Impact socket set (MM)**

<b>4109</b>			
Part no.	Socket	20/25.0/26.0/0.6'	1250g
445 11...24	Content: 1/2"DR. 10-Impact socket 11; 12; 13; 14; 16; 17; 19; 21; 22; 24 mm		

**10pc 1/2" Impact deep socket set (SAE)**

<b>4107S</b>			
Part no.	Socket	10/16.9/27.9/0.7'	2690g
44585 5.16...3.4	Content: 1/2"DR. 10-Impact deep socket 3/8"; 7/16"; 1/2"; 9/16"; 5/8"; 11/16"; 3/4"; 13/16"; 7/8"; 15/16"		

**10pc 1/2" Impact socket set (SAE)**

<b>4109S</b>			
Part no.	Socket	20/25.0/26.0/0.6'	1250g
445 3.8...15.16	Content: 1/2"DR. 10-Impact socket 3/8"; 7/16"; 1/2"; 9/16"; 5/8"; 11/16"; 3/4"; 13/16"; 7/8"; 15/16"		



**10pc 1/2" star impact socket bit set**

<b>4108</b>			
Part no.	Bit	20/18.0/19.0/0.82'	900g
246055 20...70	Content: 1/2"DR. 10-Star impact socket bit T20; T25; T27; T30; T40; T45; T50; T55; T60; T70 (55mmL)		

**10pc 1/2" Hex impact socket bit set**

<b>41012</b>			
Part no.	Bit	20/21.5/22.5/0.82'	1075g
244060 04...19	Content: 1/2"DR. 10-Hex impact socket bit (one-piece) 4; 5; 6; 7; 8; 10; 12; 14; 17; 19 mm (60mmL)		



**10pc 1/2" Star impact socket bit set**

<b>41013</b>			
Part no.	Bit	20/23.0/24.0/0.82'	1150g
246060 20...70	Content: 1/2"DR. 10-Star impact socket bit (one-piece) T20; T25; T27; T30; T40; T45; T50; T55; T60; T70 (60mmL)		



**11pc 1/2" Impact wrench socket set**

<b>4118</b>			
Part no.	Socket	6/15.9/16.9/1.2'	2650g
445 10...17	Content: 1/2"DR. 10-Impact socket 10; 11; 12; 13; 14; 16; 17 mm		
82441	1-Impact ratchet		
8044075MPB	1-Impact Extension 75mmL		
809QC	1-Quick connector (20MP)		
638M	1-Mini oiler		



**11pc 1/2" Star impact socket set**

<b>4117</b>			
Part no.	Socket	20/23.7/24.7/0.82'	1185g
446 06...24	Content: 1/2"DR. 10-Star impact socket E6; E7; E8; E10; E12; E14; E16; E18; E20; E22; E24		



**11pc 1/2" Impact wrench socket set**

<b>4118-2</b>			
Part no.	Socket	6/15.9/16.9/1.2'	2650g
445 10...17	Content: 1/2"DR. 10-Impact socket 10; 11; 12; 13; 14; 16; 17 mm		
82442	1-Impact ratchet		
8044075MPB	1-Extension 75mmL		
809QC	1-Impact Quick connector (20MP)		
638M	1-Mini oiler		



**11pc 1/2" Impact deep socket set**

<b>4119</b>			
Part no.	Socket	6/16.2/17.2/0.9'	2700g
44585 12...32	Content: 1/2"DR. 11-6pt. Flank impact deep socket 12; 14; 17; 19; 21; 22; 23; 24; 27; 30; 32 mm		

**15pc 1/2" Impact wrench socket set**

<b>4142B</b>			
Part no.	Socket	4/20.0/21.0/1.2'	5000g
445 10...24	Content: 1/2"DR. 10-Impact socket 10; 11; 12; 13; 14; 17; 19; 21; 22; 24 mm		
82542	1-Impact wrench		
8044125MPB	1-Impact extension 125mmL		
80541MPB	1-Impact universal joint		
809QC	1-Quick connector (20MP)		
638M	1-Mini oiler		





**14pc 1/2" Impact wrench socket set**

<b>4142</b>			
Part no.	Socket	4/20.0/21.0/1.2'	5000g
445 10...24	Content: 1/2"DR. 11-Impact socket 10; 11; 12; 13; 14; 17; 19; 21; 22; 24 mm		
82541	1-Impact wrench		
8044125MPB	1-Impact extension 125mmL		
80541MPB	1-Impact universal joint		
809QC	1-Quick connector (20MP)		
638M	1-Mini oiler		





### 15pc 1/2" Impact wrench socket set

<b>4142-3</b>			
Part no.	Socket	4/20.0/21.0/1.2'	5000g
445 10...24	Content: 1/2"DR. 10-Impact socket 10; 11; 12; 13; 14; 17; 19; 21; 22; 24 mm		
82543	1-Mini impact wrench		
8044125MPB	1-Impact extension 125mmL		
80541MPB	1-Impact universal joint		
809QC	1-Quick connector (20MP)		
638M	1-Mini oiler		



### 15pc 1/2" Impact wrench socket set

<b>4142-4</b>			
Part no.	Socket	4/20.0/21.0/1.2'	5000g
445 10...24	Content: 1/2"DR. 10-Impact socket 10; 11; 12; 13; 14; 17; 19; 21; 22; 24 mm		
82544	1-Mini composite impact wrench		
8044125MPB	1-Impact extension 125mmL		
80541MPB	1-Impact universal joint		
809QC	1-Quick connector (20MP)		
638M	1-Mini oiler		





**14pc 1/2" Impact socket set**

<b>41451S</b>			
Part no.	Socket	1/23.0/24.0/1.25'	23kg
50141S 445 10...32	Content: 1/2"DR. 1-Short socket storage 145-6pt. Flank impact socket Each 11pcs - 10; 11; 12; 13; 14; 16 mm Each 10pcs - 17; 19 mm Each 9pcs - 21 mm Each 8pcs - 22; 23; 24 mm Each 7pcs - 26; 27 mm Each 6pcs - 30; 32 mm		

**19pc 1/2" Impact socket set**

<b>4193</b>			
Part no.	Socket	6/18.8/19.8/0.9'	3130g
445 10...32 8044125MPB	Content: 1/2"DR. 18- 6pt. Flank impact socket 10; 11; 12; 13; 14; 15; 16; 17; 18; 19; 21; 22; 23; 24; 26; 27; 30; 32 mm 1- Impact extension 125mmL		

**14pc 1/2" Impact deep socket set**

<b>41451D</b>			
Part no.	Socket	1/35.0/36.0/1.25'	35kg
50141D 44585 10...32	Content: 1/2"DR. 1-Deep socket storage 145-6pt. Flank deep impact socket Each 11pcs - 10; 11; 12; 13; 14; 16 mm Each 10pcs - 17; 19 mm Each 9pcs - 21 mm Each 8pcs - 22; 23; 24 mm Each 7pcs - 26; 27 mm Each 6pcs - 30; 32 mm		



**1/2" Phillips impact socket bit**

<b>241</b>				
Part no.	size	mm	g	pc/box
241552	PH.2	55	104	10
241553	PH.3	55	104	10
241554	PH.4	55	104	10



**1/2" Pozidriv impact socket bit**

<b>242</b>				
Part no.	size	mm	g	pc/box
242552	PZ.2	55	104	10
242553	PZ.3	55	104	10
242554	PZ.4	55	104	10



**1/2" Slotted impact socket bit**

<b>243</b>		<i>l</i>		
Part no.	size	mm	g	pc/box
2435508	1.2x8	55	102	10
2435510	1.6x10	55	104	10
2435512	2.0x12	55	104	10
2435514	2.5x14	55	106	10
2435516	2.5x16	55	108	10



**1/2" Hex impact socket bit**

<b>244</b>		<i>l</i>		
Part no.	size	mm	g	pc/box
24405503	3	55	104	10
24405504	4	55	104	10
24405505	5	55	106	10
24405506	6	55	106	10
24405507	7	55	106	10
24405508	8	55	112	10
24405510	10	55	114	10
24405512	12	55	122	10
24406514	14	65	186	10
24407017	17	70	232	10
24407019	19	70	272	10
24410005	5	100	136	10
24410006	6	100	136	10
24410007	7	100	136	10
24410008	8	100	138	10



**1/2" Hex impact socket bit (one-piece)**

<b>244060</b>		<i>l</i>		
Part no.	size	mm	g	pc/box
24406004	4	60	70	10
24406005	5	60	70	10
24406006	6	60	74	10
24406007	7	60	74	10
24406008	8	60	76	10
24406010	10	60	94	10
24406012	12	60	103	10
24406014	14	60	115	10
24406017	17	60	138	10
24406019	19	60	154	10
24407804	4	78	72	10
24407805	5	78	75	10
24407806	6	78	81	10
24407807	7	78	84	10
24407808	8	78	87	10
24407810	10	78	109	10
24407812	12	78	124	10
24407814	14	78	140	10
24407817	17	78	180	10
24407819	19	78	204	10
24407822	22	78	280	10
24407824	24	78	320	10



**1/2" DR. Star impact socket bit (one-piece)**

<b>246</b>		<i>l</i>		
Part no.	size	mm	g	pc/box
24620	T20	40	61	10
24625	T25	40	61	10
24627	T27	40	61	10
24630	T30	40	61	10
24640	T40	40	62	10
24645	T45	40	62	10
24650	T50	40	64	10
24655	T55	40	69	10
24660	T60	40	74	10
24670	T70	40	86	10



**1/2" DR. Star impact socket bit (one-piece)**

<b>246060</b>		<i>l</i>		
Part no.	size	mm	g	pc/box
24606020	T20	60	63	10
24606025	T25	60	63	10
24606027	T27	60	63	10
24606030	T30	60	63	10
24606040	T40	60	67	10
24606045	T45	60	71	10
24606050	T50	60	74	10
24606055	T55	60	88	10
24606060	T60	60	99	10
24606070	T70	60	108	10



**1/2" Spline impact socket bit**

<b>248</b>		<i>l</i>		
Part no.	size	mm	g	pc/box
24805505	M5	55	104	10
24805506	M6	55	104	10
24805508	M8	55	104	10
24805510	M10	55	106	10
24805512	M12	55	114	10
24810005	M5	100	146	10
24810006	M6	100	148	10
24810008	M8	100	148	10
24810010	M10	100	150	10
24810012	M12	100	158	10



**1/2" Star impact socket bit**

<b>246</b>		<i>l</i>		
Part no.	size	mm	g	pc/box
24605520	T20	55	106	10
24605525	T25	55	106	10
24605527	T27	55	106	10
24605530	T30	55	108	10
24605540	T40	55	108	10
24605545	T45	55	108	10
24605550	T50	55	112	10
24605555	T55	55	122	10
24605560	T60	55	124	10
24605570	T70	55	142	10
24610040	T40	100	138	10
24610045	T45	100	140	10
24610050	T50	100	142	10
24610055	T55	100	160	10
24610060	T60	100	162	10



**1/2" DR. Square impact socket**

<b>441</b>		<i>l</i>		
Part no.	size	mm	g	pc/box
44114	14	40	96	10



**1/2"DR. 6pt. Flank impact socket**

<b>445</b>		<i>l</i>		
Part no.	size	mm	g	pc/box
44508	8	38	71	10
44509	9	38	71	10
44510	10	38	72	10
44511	11	38	72	10
44512	12	38	74	10
44513	13	38	77	10
44514	14	38	80	10
44515	15	38	82	10
44516	16	38	85	10
44517	17	38	89	10
44518	18	38	89	10
44519	19	38	102	10
44520	20	38	124	10
44521	21	38	124	10
44522	22	43	148	10
44523	23	43	148	10
44524	24	43	154	10
44525	25	43	160	10
44526	26	43	181	10
44527	27	43	181	10
44528	28	45	197	10
44529	29	45	200	10
44530	30	45	218	10
44531	31	45	218	10
44532	32	45	218	10
44533	33	46	223	10
44534	34	46	230	10
44535	35	48	268	10
44536	36	48	289	10
44538	38	50	314	10
44539	39	52	350	10
44541	41	55	388	10
4455.16	5/16"	38	70	10
4453.8	3/8"	38	72	10
4457.16	7/16"	38	74	10
4451.2	1/2"	38	77	10
4459.16	9/16"	38	77	10
4455.8	5/8"	38	85	10
44511.16	11/16"	38	104	10
4453.4	3/4"	38	120	10
44513.16	13/16"	38	130	10
4457.8	7/8"	43	147	10
44515.16	15/16"	43	153	10
4451.0	1"	43	169	10
4451.1.16	1-1/16"	43	173	10
4451.1.8	1-1/8"	45	193	10
4451.3.16	1-3/16"	45	201	10
4451.1.4	1-1/4"	45	210	10



**1/2"DR. 6pt. Flank impact middle deep socket**

<b>44552</b>		<i>l</i>		
Part no.	size	mm	g	pc/box
4455214	14	52	100	10
4455217	17	52	125	10
4455219	19	52	142	10
4455221	21	52	161	10
4455223	23	52	174	10
4455224	24	52	185	10



**1/2"DR. 6pt. Flank impact thin-wall middle deep socket**

<b>44552..TH</b>		<i>l</i>		
Part no.	size	mm	g	pc/box
4455214TH	14	52	86	10
4455217TH	17	52	99	10
4455219TH	19	52	118	10
4455221TH	21	52	130	10
4455223TH	23	52	144	10
4455224TH	24	52	152	10















**1/2"DR. 6pt. Flank impact deep socket**

<b>44585</b>		<i>l</i>		
Part no.	size	mm	g	pc/box
4458508	8	85	110	10
4458509	9	85	120	10

<b>44585</b>		<i>l</i>		
Part no.	size	mm	g	pc/box
4458510	10	85	123	10
4458511	11	85	135	10
4458512	12	85	147	10
4458513	13	85	154	10
4458514	14	85	178	10
4458515	15	85	181	10
4458516	16	85	204	10
4458517	17	85	209	10
4458518	18	85	215	10
4458519	19	85	242	10
4458520	20	85	277	10
4458521	21	85	279	10
4458522	22	85	299	10
4458523	23	85	336	10
4458524	24	85	336	10
4458525	25	85	367	10
4458526	26	85	367	10
4458527	27	85	367	10
4458528	28	85	377	10
4458529	29	85	393	10
4458530	30	85	400	10
4458531	31	85	405	10
4458532	32	85	458	10
4458533	33	85	466	10
4458534	34	85	475	10
4458535	35	85	489	10
4458536	36	85	499	10
4458538	38	85	518	5
4458541	41	85	545	5
445855.16	5/16"	85	110	10
445853.8	3/8"	85	127	10
445857.16	7/16"	85	133	10
445851.2	1/2"	85	157	10
445859.16	9/16"	85	171	10
445855.8	5/8"	85	201	10
4458511.16	11/16"	85	211	10
445853.4	3/4"	85	232	10
4458513.16	13/16"	85	274	10
445857.8	7/8"	85	305	10
4458515.16	15/16"	85	341	10
445851.0	1"	85	350	10
445851.1.16	1-1/16"	85	360	10
445851.1.8	1-1/8"	85	372	10
445851.3.16	1-3/16"	85	393	10
445851.1.4	1-1/4"	85	418	10









**1/2"DR. Wheel nut 6pt. flank impact socket**





<b>44585..C</b>		<i>l</i>			
Part no.	size	mm	g	color	pc/box
4458514C	14	85	175		1
4458515C	15	85	180		1
4458517C	17	85	225		1
4458519C	19	85	240		1
4458521C	21	85	260		1
4458522C	22	85	305		1
4458523C	23	85	310		1
4458524C	24	85	312		1
4458527C	27	85	362		1



**1/2"DR. Wheel nut 6pt. flank impact socket**

<b>445150..C</b>		<i>l</i>			
Part no.	size	mm	g	color	pc/box
44515017C	17	150	365		1
44515019C	19	150	395		1
44515021C	21	150	420		1



**1/2"DR. 6pt. Flank impact thin-wall deep socket**

<b>44585..TH</b>			<i>l</i>		
Part no.	size	mm	mm	g	pc/box
4458517 TH	17	24	85	173	10
4458519 TH	19	26	85	219	10
4458521 TH	21	29	85	240	10







**1/2"DR. Star impact socket**

<b>446</b>		<i>l</i>		
Part no.	Socket	mm	g	pc/box
44606	E6	38	62	10
44607	E7	38	62	10
44608	E8	38	62	10
44610	E10	38	74	10
44611	E11	38	74	10
44612	E12	38	77	10
44614	E14	38	77	10
44616	E16	38	77	10
44618	E18	38	124	10
44620	E20	38	126	10
44622	E22	38	132	10
44624	E24	42	155	10





**1/2"DR. 12pt. Impact socket**

<b>448</b>		<i>l</i>		
Part no.	Socket	mm	g	pc/box
44808	8	38	74	10
44810	10	38	74	10
44811	11	38	74	10
44812	12	38	74	10
44813	13	38	76	10
44814	14	38	76	10
44815	15	38	81	10
44816	16	38	84	10
44817	17	38	86	10
44818	18	38	86	10
44819	19	38	102	10
44821	21	38	120	10
44822	22	43	147	10
44823	23	43	147	10
44824	24	43	148	10
44826	26	43	168	10
44827	27	43	168	10
44828	28	45	185	10
44830	30	45	204	10
44832	32	45	206	10





**1/2"DR. 12pt. Impact deep socket**

<b>44885</b>		<i>l</i>		
Part no.	Socket	mm	g	pc/box
4488510	10	85	123	10
4488512	12	85	144	10
4488514	14	85	174	10
4488517	17	85	222	10
4488519	19	85	244	10
4488530	30	85	367	10
4488532	32	85	405	10
4488536	36	85	479	10



**1/2"DR. Impact ratchet wrench**



<b>82441</b>	<i>l</i>		
Part no.	mm	g	pc/box
82441	250mm-10"	1316	1

**Specifications :**

- Square Drive..... 1/2"
- Free Speed (R.P.M.)..... 160
- Max. Torque (Ft/Lbs) / (N-M)..... 60 / 81
- Air Pressure (PSI)..... 90
- AIR Inlet (P.T.)..... 1/4"
- Air Consumption (C.F.M.)..... 4



**1/2"DR. Super duty impact ratchet wrench**

<b>82442</b>	<i>l</i>		
Part no.	mm	g	pc/box
82442	260mm-10.3"	1130	1

**Specifications :**

- Square Drive..... 1/2"
- Free Speed (R.P.M.)..... 160
- Working Torque Range (Ft/Lbs) / (N-M)..... 10-55 / 14-75
- Max. Torque (Ft/Lbs) / (N-M)..... 60 / 81
- Air Pressure (PSI)..... 90
- AIR Inlet (P.T.)..... 1/4"
- Air Consumption (C.F.M.)..... 3



**1/2"DR. Impact wrench**

<b>82541</b>	<b>l</b>		
Part no.	mm	g	pc/box
82541	170mm-6.8"	2900	1

**Specifications :**  
 Square Drive..... 1/2"  
 Free Speed (R.P.M.)..... 7000  
 Max. Torque (Ft/Lbs) / (N-M)..... 400/ 542  
 Air Pressure (PSI)..... 90  
 AIR Inlet (P.T.)..... 1/4"  
 Air Consumption (C.F.M.)..... 4

**1/2"DR. Mini impact wrench**

<b>82543</b>	<b>l</b>		
Part no.	mm	g	pc/box
82543	145mm-5.7"	1500	1

**Specifications :**  
 Square Drive..... 1/2"  
 Free Speed (R.P.M.)..... 12500  
 Working Torque Range (Ft/Lbs) / (N-M)..... 90-280 / 120-378  
 Max. Torque (Ft/Lbs) / (N-M)..... 300/ 400  
 Air Pressure (PSI)..... 90  
 AIR Inlet (P.T.)..... 1/4"  
 Air Consumption (C.F.M.)..... 4



**1/2"DR. Impact wrench**

<b>82542</b>	<b>l</b>		
Part no.	mm	g	pc/box
82542	250mm-9.8"	3088	1

**Specifications :**  
 Square Drive..... 1/2"  
 Free Speed (R.P.M.)..... 7000  
 Max. Torque (Ft/Lbs) / (N-M)..... 500/ 678  
 Air Pressure (PSI)..... 90  
 AIR Inlet (P.T.)..... 1/4"  
 Air Consumption (C.F.M.)..... 4.4

**1/2"DR. Mini composite impact wrench**

<b>82544</b>	<b>l</b>		
Part no.	mm	g	pc/box
82544	154mm-6"	1200	1

**Specifications :**  
 Square Drive..... 1/2"  
 Free Speed (R.P.M.)..... 12500  
 Working Torque Range (Ft/Lbs) / (N-M)..... 90-260 / 120-351  
 Max. Torque (Ft/Lbs) / (N-M)..... 300/ 400  
 Air Pressure (PSI)..... 90  
 AIR Inlet (P.T.)..... 1/4"  
 Air Consumption (C.F.M.)..... 4



**1/2"DR. Super duty composite impact wrench**

<b>82545</b>	<b>l</b>		
Part no.	mm	g	pc/box
82545	190mm-7.5"	1850	1

**Specifications :**

Square Drive..... 1/2"  
 Free Speed (R.P.M.)..... 9000  
 Working Torque Range (Ft/Lbs) / (N-M)..... 50-500 / 67-665  
 Max. Torque (Ft/Lbs) / (N-M)..... 650 / 865  
 Air Pressure (PSI)..... 90  
 AIR Inlet (P.T.)..... 1/4"  
 Air Consumption (C.F.M.)..... 5



**1/2"DR. Impact wrench**

<b>82547</b>	<b>l</b>		
Part no.	mm	g	pc/box
82547	190mm-7.5"	2550	1

**Specifications :**

Square Drive..... 1/2"  
 Free Speed (R.P.M.)..... 7000  
 Max. Torque (Ft/Lbs) / (N-M)..... 337/450  
 Air Pressure (PSI)..... 90  
 AIR Inlet (P.T.)..... 1/4"  
 Air Consumption (C.F.M.)..... 4



**1/2"DR. Impact wrench (with grip)**

<b>82546</b>	<b>l</b>		
Part no.	mm	g	pc/box
82546	180mm-7"	2500	1

**Specifications :**

Square Drive..... 1/2"  
 Free Speed (R.P.M.)..... 7000  
 Working Torque Range (Ft/Lbs) / (N-M)..... 30-320 / 40-435  
 Max. Torque (Ft/Lbs) / (N-M)..... 550 / 748  
 Air Pressure (PSI)..... 90  
 AIR Inlet (P.T.)..... 1/4"  
 Air Consumption (C.F.M.)..... 4



**1/2"DR. Impact wrench**



<b>82548</b>	<b>l</b>		
Part no.	mm	g	pc/box
82548	210mm-8.3"	2150	1

**Specifications :**

Square Drive..... 1/2"  
 Free Speed (R.P.M.)..... 6500  
 Max. Torque (Ft/Lbs) / (N-M)..... 525/700  
 Air Pressure (PSI)..... 90  
 AIR Inlet (P.T.)..... 1/4"  
 Air Consumption (C.F.M.)..... 3



**5" Angle grinder with lever throttle**



<b>82601</b>	<b>l</b>		
Part no.	mm	g	pc/box
82601	235mm-9.3"	1800	1

**Specifications :**

- Spindle Thread Size..... M10x1.5
- Free Speed (R.P.M.)..... 11000
- Air Pressure (PSI)..... 90
- AIR Inlet (P.T.)..... 1/4"
- Air Consumption (C.F.M.)..... 5



**6mm Industrial grader air die grinder**



<b>82602</b>	<b>l</b>		
Part no.	mm	g	pc/box
82602	145mm-5.7"	600	1

**Specifications :**



- Collect Size..... 3mm; 6mm; 1/8"; 1/4"
- Free Speed (R.P.M.)..... 22000
- Air Pressure (PSI)..... 90
- AIR Inlet (P.T.)..... 1/4"
- Air Consumption (C.F.M.)..... 3



**1/2"DR.Impact extension (pin type)**



<b>8044..MPP</b>	<b>l</b>		
Part no.	mm	g	pc/box
8044075MPP	75-3"	148	10
8044125MPP	125-5"	230	10
8044250MPP	250-10"	443	5

**1/2"DR.Impact extension (ball type)**

<b>8044..MPB</b>	<b>l</b>		
Part no.	mm	g	pc/box
8044075MPB	75-3"	170	10
8044125MPB	125-5"	230	10
8044250MPB	250-10"	420	5





**1/2"DR. Universal joint (pin type)**

<b>80541MPP</b>	<b>l</b>		
Part no.	mm	g	pc/box
80541MPP	75	141	10





**1/2"DR. Universal joint (ball type)**

<b>80541MPB</b>	<b>l</b>		
Part no.	mm	g	pc/box
80541MPB	75	139	10







**1/2"DR. Impact locking extension (ball type)**

<b>8084..MPB</b>	<b><i>l</i></b>		
Part no.	mm	g	pc/box
8084075MPB	75-3"	170	10
8084125MPB	125-5"	250	10
8084250MPB	250-10"	450	5





**O-ring & Pin for 1/2"DR.**

				
Part no.	mm	mm	g	pc/box
R1935	Ø19- Ø3.5		2	50
P2030		20L- Ø3.0	2	50
R2435	Ø24- Ø3.5		2	50
P2530		25L- Ø3.0	2	50





**1/2"DR. Adaptor (pin type)**

<b>8094..MPP</b>		<b><i>l</i></b>		
Part no.	Size	mm	g	pc/box
80943MPP	1/2"(F)x3/8"(M)	38	70	10
80946MPP	1/2"(F)x3/4"(M)	48	140	10



**1/2"DR. Adaptor (ball type)**

<b>8094..MPB</b>		<b><i>l</i></b>		
Part no.	Size	mm	g	pc/box
80943MPB	1/2"(F)x3/8"(M)	38	72	10
80946MPB	1/2"(F)x3/4"(M)	48	145	10





**8pc 3/4" Impact socket set (MM)**

<b>6081</b>			
Part no.	Socket	6/21.0/22.0/1.2'	3500g
465 26...38	Content: 3/4"DR. 8-Impact socket 26; 27; 29; 30; 32; 35; 36; 38 mm		

**8pc 3/4" Impact socket set (SAE)**

<b>6081S</b>			
Part no.	Socket	6/21.0/22.0/1.2'	3500g
465 1.0...1.1.2	Content: 3/4"DR. 8-Impact socket 1"; 1-1/16"; 1-1/8"; 1-1/4"; 1-5/16"; 1-3/8"; 1-7/16"; 1-1/2"		



**8pc 3/4" Impact deep socket set (MM)**

<b>6081D</b>			
Part no.	Socket	2/13.4/14.4/0.54'	6700g
465100 26...38	Content: 3/4"DR. 8-Impact deep socket 26; 27; 29; 30; 32; 35; 36; 38 mm		

**8pc 3/4" Impact deep socket set (SAE)**

<b>6081DS</b>			
Part no.	Socket	2/13.4/14.4/0.54'	6700g
465100 26...38	Content: 3/4"DR. 8-Impact deep socket 1"; 1-1/16"; 1-1/8"; 1-1/4"; 1-5/16"; 1-3/8"; 1-7/16"; 1-1/2"		



**8pc 3/4" Impact deep socket set (MM)**

<b>6082D</b>			
Part no.	Socket	2/13.4/14.4/0.54'	6700g
465100 27...41	Content: 3/4"DR. 6-6pt. Flank impact deep socket 27; 30; 32; 35; 38; 41 mm		
46190 19...21	2-Square impact deep socket 19; 21 mm		

**8pc 3/4" Impact deep socket set (SAE)**

<b>6082DS</b>			
Part no.	Socket	2/13.4/14.4/0.54'	6700g
465100 1.1.16...1.1.2	Content: 3/4"DR. 6-6pt. Flank impact deep socket 1-1/16"; 1-1/8"; 1-3/16"; 1-1/4"; 1-3/8"; 1-1/2"		
46190 3.4...13.16	2-Square impact deep socket 3/4"; 13/16"		



11pc 3/4" Impact wrench socket set			
<b>6111</b>			
Part no.	Socket	2/17.6/18.6/1.4'	8.8kg
465 22...41	Content: 3/4"DR. 6- Impact socket 22; 24; 27; 30; 32; 36; 38; 41 mm		
82563	1- Impact wrench		
638M	1- Mini oiler		



11pc 3/4" Impact wrench socket set			
<b>6111D</b>			
Part no.	Socket	2/17.6/18.6/1.4'	11kg
465100 22...41	Content: 3/4"DR. 6- Impact deep socket 22; 24; 27; 30; 32; 36; 38; 41 mm		
82563	1- Impact wrench		
638M	1- Mini oiler		



11pc 3/4" Impact wrench socket set			
<b>6111-1</b>			
Part no.	Socket	2/17.6/18.6/1.4'	8.8kg
465 22...41	Content: 3/4"DR. 6- Impact socket 22; 24; 27; 30; 32; 36; 38; 41 mm		
82561	1- Impact wrench with grip		
638M	1- Mini oiler		



11pc 3/4" Impact wrench socket set			
<b>6111D-1</b>			
Part no.	Socket	2/17.6/18.6/1.4'	11kg
465100 22...41	Content: 3/4"DR. 6- Impact deep socket 22; 24; 27; 30; 32; 36; 38; 41 mm		
82561	1- Impact wrench with grip		
638M	1- Mini oiler		



**3/4" Hex impact socket bit (one-piece)**

<b>26490</b>		<i>l</i>		
Part no.	Socket	mm	g	pc/box
2649014	14	90	420	2
2649017	17	90	455	2
2649019	19	90	496	2
2649022	22	90	520	2
2649024	24	90	561	2
2649027	27	90	650	2
2649030	30	90	670	2
2649032	32	90	740	2

**3/4" DR. 6pt. Flank impact socket**

<b>465</b>		<i>l</i>		
Part no.	Socket	mm	g	pc/box
46517	17	50	254	1
46518	18	50	252	1
46519	19	50	248	1
46520	20	50	254	1
46521	21	50	254	1
46522	22	50	262	1
46523	23	50	266	1
46524	24	50	268	1
46525	25	50	268	1
46526	26	50	268	1
46527	27	54	294	1
46528	28	54	364	1
46529	29	54	362	1
46530	30	54	376	1
46531	31	54	384	1
46532	32	57	380	1
46533	33	57	412	1
46534	34	57	434	1
46535	35	57	438	1
46536	36	57	432	1
46537	37	57	444	1
46538	38	57	452	1
46539	39	57	478	1
46540	40	57	480	1
46541	41	57	498	1
46542	42	57	564	1
46543	43	63	580	1
46544	44	63	626	1
46545	45	63	658	1
46546	46	63	772	1
46548	48	68	826	1
46550	50	68	880	1
46552	52	70	990	1
46554	54	70	1022	1
46555	55	72	1136	1
46557	57	72	1178	1
46558	58	75	1190	1
46560	60	75	1282	1
46565	65	78	1548	1
4653.4	3/4"	50	244	1
46513.16	13/16"	50	258	1
4657.8	7/8"	50	260	1
46515.16	15/16"	50	264	1
4651.0	1"	50	264	1
4651.1.16	1-1/16"	54	300	1
4651.1.8	1-1/8"	54	366	1
4651.3.16	1-3/16"	54	366	1
4651.1.4	1-1/4"	57	390	1
4651.5.16	1-5/16"	57	418	1
4651.3.8	1-3/8"	57	442	1
4651.7.16	1-7/16"	57	464	1
4651.1.2	1-1/2"	57	452	1
4651.9.16	1-9/16"	57	524	1
4651.5.8	1-5/8"	57	524	1
4651.11.16	1-11/16"	63	282	1





**3/4" DR. Square impact socket**

<b>461</b>		<i>l</i>		
Part no.	Socket	mm	g	pc/box
46117	17	50	398	1
46119	19	50	400	1
46121	21	50	412	1
46111.16	11/16"	50	398	1
4613.4	3/4"	50	400	1
46113.16	13/16"	50	412	1





**3/4" DR. Square impact deep socket**

<b>46190</b>		<i>l</i>		
Part no.	Socket	mm	g	pc/box
4619017	17	90	520	1
4619019	19	90	520	1
4619020	20	90	520	1
4619021	21	90	520	1
4619011.16	11/16"	90	520	1
46190.3.4	3/4"	90	520	1
46190.13.16	13/16"	90	520	1

<b>465</b>		<i>l</i>		
Part no.	Socket	mm	g	pc/box
4651.3.4	1-3/4"	63	686	1
4651.13.16	1-13/16"	63	748	1
4651.7.8	1-7/8"	68	850	1
4651.15.16	1-15/16"	68	910	1
4652.0	2"	68	998	1
4652.1.16	2-1/16"	70	990	1
4652.1.8	2-1/8"	70	1022	1
4652.3.16	2-3/16"	72	1062	1
4652.1.4	2-1/4"	72	1176	1
4652.5.16	2-5/16"	75	1190	1
4652.3.8	2-3/8"	75	1282	1





**3/4" DR. 6pt. Flank impact deep socket**

<b>465100</b>		<i>l</i>		
Part no.	Socket	mm	g	pc/box
46510019	19	100	426	1
46510020	20	100	434	1
46510021	21	100	456	1
46510022	22	100	496	1
46510023	23	100	514	1
46510024	24	100	704	1
46510025	25	100	476	1
46510026	26	100	480	1
46510027	27	100	506	1
46510028	28	100	568	1
46510029	29	100	576	1
46510030	30	100	626	1
46510032	32	100	598	1
46510033	33	100	650	1
46510034	34	100	710	1
46510035	35	100	728	1
46510036	36	100	726	1
46510037	37	100	748	1
46510038	38	100	700	1
46510039	39	100	828	1
46510041	41	100	866	1
46510042	42	100	936	1
46510046	46	100	1176	1
46510048	48	100	1282	1
46510050	50	100	1312	1
46510055	55	100	1358	1
46510060	60	100	1734	1
46510065	65	100	1710	1
4651003.4	3/4"	100	434	1
46510013.16	13/16"	100	456	1
4651007.8	7/8"	100	496	1
46510015.16	15/16"	100	512	1
4651001.0	1"	100	480	1
4651001.1.16	1-1/16"	100	506	1
4651001.1.8	1-1/8"	100	568	1
4651001.3.16	1-3/16"	100	626	1
4651001.1.4	1-1/4"	100	598	1
4651001.5.16	1-5/16"	100	638	1
4651001.3.8	1-3/8"	100	714	1
4651001.7.16	1-7/16"	100	770	1
4651001.1.2	1-1/2"	100	848	1
4651001.9.16	1-9/16"	100	856	1
4651001.5.8	1-5/8"	100	852	1
4651001.11.16	1-11/16"	100	1028	1
4651001.3.4	1-3/4"	100	1190	1
4651001.13.16	1-13/16"	100	1148	1
4651001.7.8	1-7/8"	100	1316	1
4651002.0	2"	100	1430	1



**3/4" DR. 6pt. Flank impact middle deep socket**

<b>465..</b>		<i>l</i>		
Part no.	Socket	mm	g	pc/box
4656021	21	60	228	1
4656022	22	60	228	1
4656023	23	60	227	1
4656024	24	60	226	1
4658526	26	85	384	1
4658527	27	85	392	1
4658530	30	85	456	1
4658532	32	85	450	1



**3/4"DR. Star impact deep socket**

<b>466110</b>		<i>l</i>		
Part no.	Socket	mm	g	pc/box
46611018	E18	110	520	1
46611020	E20	110	540	1

**3/4"DR. Impact wrench (with grip)**

<b>82561</b>	<i>l</i>		
Part no.	mm	g	pc/box
82561	217mm-8.5"	4100	1



**3/4"DR. 12pt impact socket**

<b>468</b>		<i>l</i>		
Part no.	Socket	mm	g	pc/box
46817	17	50	248	1
46819	19	50	252	1
46820	20	50	230	1
46821	21	50	232	1
46822	22	50	350	1
46823	23	50	360	1
46824	24	50	360	1
46826	26	50	336	1
46827	27	54	323	1
46828	28	54	356	1
46830	30	54	360	1
46832	32	57	370	1
46833	33	57	400	1
46834	34	57	418	1
46835	35	57	400	1
46836	36	57	420	1
46838	38	57	454	1
46841	41	57	608	1
46846	46	63	740	1

**Specifications :**

- Square Drive..... 3/4"
- Free Speed (R.P.M.)..... 7250
- Working Torque Range (Ft/Lbs) / (N-M)..... 200-800 / 271-1084
- Max. Torque (Ft/Lbs) / (N-M)..... 1100 / 1491
- Air Pressure (PSI)..... 90
- AIR Inlet (P.T.)..... 1/4"
- Air Consumption (C.F.M.)..... 4



**3/4"DR. Impact wrench**

<b>82563</b>	<i>l</i>		
Part no.	mm	g	pc/box
82563	230mm-9.1"	4678	1

**Specifications :**

- Square Drive..... 3/4"
- Free Speed (R.P.M.)..... 6500
- Max. Torque (Ft/Lbs) / (N-M)..... 750 / 1016
- Air Pressure (PSI)..... 90
- AIR Inlet (P.T.)..... 1/4"
- Air Consumption (C.F.M.)..... 7





**3/4"DR. Impact wrench (Mini type)**

<b>82564</b>	<b>l</b>		
Part no.	mm	g	pc/box
82564	220mm-8.7"	2800	1

**Specifications :**

- Square Drive..... 3/4"
- Free Speed (R.P.M.)..... 6000
- Max. Torque (Ft/Lbs) / (N-M)..... 637 / 850
- Air Pressure (PSI)..... 90
- AIR Inlet (P.T.)..... 1/4"
- Air Consumption (C.F.M.)..... 4



**3/4"DR. Impact wrench (Powerful type)**

<b>82565</b>	<b>l</b>		
Part no.	mm	g	pc/box
82565	280mm-11.0"	5700	1

**Specifications :**

- Square Drive..... 3/4"
- Free Speed (R.P.M.)..... 4000
- Max. Torque (Ft/Lbs) / (N-M)..... 1350 / 1800
- Air Pressure (PSI)..... 90
- AIR Inlet (P.T.)..... 3/8"
- Air Consumption (C.F.M.)..... 6



**3/4" DR. Impact extension (Pin type)**

<b>8046..MPP</b>	<b>l</b>		
Part no.	mm	g	pc/box
8046100MPP	100-4"	641	2
8046175MPP	175-7"	923	2
8046250MPP	250-10"	1223	2
8046330MPP	330-13"	1544	1

**3/4" DR. Impact extension (Ball type)**

<b>8046..MPB</b>	<b>l</b>		
Part no.	mm	g	pc/box
8046100MPB	100-4"	325	2
8046175MPB	175-7"	927	2
8046250MPB	250-10"	1224	2
8046330MPB	330-13"	1546	1



**3/4" DR. Universal joint (pin type)**

<b>80561MPP</b>	<b>l</b>		
Part no.	mm	g	pc/box
80561MPP	110	602	1



**3/4" DR. Universal joint (ball type)**

<b>80561MPB</b>	<b>l</b>		
Part no.	mm	g	pc/box
80561MPB	110	624	1



**3/4" DR. Adaptor (pin type)**

<b>8096..MPP</b>				
Part no.	size	mm	g	pc/box
80964MPP	3/4"(F)x1/2"(M)	58	334	2
80968MPP	3/4"(F)x1"(M)	63	430	2



**3/4" DR. Adaptor (ball type)**

<b>8096..MPB</b>				
Part no.	size	mm	g	pc/box
80964MPB	3/4"(F)x1/2"(M)	58	320	2
80968MPB	3/4"(F)x1"(M)	63	400	2



**O-ring & Pin for 3/4"DR.**

Part no.	mm	mm	g	pc/box
R3355	∅33- ∅5.5	30L- ∅4.0	3	50
P3040				
R3755	∅37- ∅5.5	35L- ∅4.0	3	50
P3540				
R4455	∅44- ∅5.5	45L-∅4.0	3	50
P4540				



8pc 1" Impact socket set (MM)			
<b>8081</b>			
Part no.	Socket	4/24.6/25.6/0.8'	6150g
485 24...41	Content: 1"DR. 8- Impact socket 24; 27; 30; 32; 33; 36; 38; 41 mm		

8pc 1" Impact socket set (SAE)			
<b>8081S</b>			
Part no.	Socket	4/24.6/25.6/0.8'	6150g
485 15.16...1.5.8	Content: 1"DR. 8- Impact socket 15/16"; 1-1/16"; 1-3/16"; 1-1/4"; 1-5/16"; 1-7/16"; 1-1/2"; 1-5/8"		



8pc 1" Impact socket set (MM)			
<b>8081D</b>			
Part no.	Socket	2/18.4/19.4/0.59'	9200g
485100 24...41	Content: 1"DR. 8- Impact socket 24; 27; 30; 32; 33; 36; 38; 41 mm		

8pc 1" Impact socket set (SAE)			
<b>8081DS</b>			
Part no.	Socket	2/18.4/19.4/0.59'	9200g
485100 15.16...1.5.8	Content: 1"DR. 8- Impact deep socket 15/16"; 1-1/16"; 1-3/16"; 1-1/4"; 1-5/16"; 1-7/16"; 1-1/2"; 1-5/8"		





8pc 1" Impact socket set (MM)			
<b>8082</b>			
Part no.	Socket	4/24.6/25.6/0.8'	6150g
485 27...41	Content: 1"DR. 5- 6pt. Flank impact socket 27; 32; 35; 38; 41 mm		
481 17...21	3- Square impact socket 17; 19; 21 mm		

8pc 1" Impact socket set (SAE)			
<b>8082S</b>			
Part no.	Socket	4/24.6/25.6/0.8'	6150g
481 1.1.16...1.1.2	Content: 1"DR. 6- 6pt. Flank impact socket 1-1/16"; 1-1/8"; 1-3/16"; 1-1/4"; 1-3/8"; 1-1/2"		
481 3.4...13.16	2- Square impact socket 3/4"; 13/16"		





8pc 1" Impact deep socket set (MM)			
<b>8082D</b>			
Part no.	Socket	2/18.4/19.4/0.59'	9200g
485100 27...41	Content: 1"DR. 5- 6pt. Flank impact deep socket 27; 32; 35; 38; 41 mm		
48190 17...21	3- Square impact deep socket 17; 19; 21 mm		

**8pc 1" Impact deep socket set (SAE)**



<b>8082DS</b>			
Part no.	Socket	2/18.4/19.4/0.59'	9200g
481100 1.1.16...1.1.2	Content: 1"DR. 6- 6pt. Flank impact deep socket 1-1/16"; 1-1/8"; 1-3/16"; 1-1/4"; 1-3/8"; 1-1/2"		
48190 3.4...13.16	2- Square impact deep socket 3/4"; 13/16"		



**10pc 1" Impact wrench socket set**



<b>8091-1</b>			
Part no.	Socket	1/20.8/21.8/2.8'	20.8kg
485 27...41	Content: 1"DR. 8- Impact socket 27; 30; 32; 33; 35; 36; 38; 41 mm		
82581	1- Impact wrench with 9" extension		
638M	1- Mini oiler		

**10pc 1" Impact wrench socket set**

<b>8091</b>			
Part no.	Socket	1/20.8/21.8/2.8'	20.8kg
485 27...41	Content: 1"DR. 8- Impact socket 27; 30; 32; 33; 35; 36; 38; 41 mm		
82585	1- Impact wrench		
638M	1- Mini oiler		





**10pc 1" Impact wrench socket set**

<b>8091MD</b>			
Part no.	Socket	1/21.0/22.0/2.8'	21kg
48580 27...41	Content: 1"DR. 8- Impact middle deep socket 27; 30; 32; 33; 35; 36; 38; 41 mm		
82585	1- Impact wrench		
638M	1- Mini oiler		





**10pc 1" Impact wrench socket set**

<b>8091D</b>			
Part no.	Socket	1/21.7/22.7/2.8"	21.7kg
485100 27...41	Content: 1"DR. 8- Impact deep socket 27; 30; 32; 33; 35; 36; 38; 41 mm		
82585	1- Impact wrench		
638M	1- Mini oiler		





**10pc 1" Impact wrench socket set**



<b>8091D-1</b>			
Part no.	Socket	1/21.7/22.7/2.8"	21.7kg
485100 27...41	Content: 1"DR. 8- Impact deep socket 27; 30; 32; 33; 35; 36; 38; 41 mm		
82581	1- Impact wrench with 9" extension		
638M	1- Mini oiler		



**1"DR. Square impact socket**





<b>481</b>		<i>l</i>		
Part no.	Socket	mm	g	pc/box
48117	17	60	570	1
48119	19	60	580	1
48121	21	60	590	1
48111.16	11/16"	60	565	1
4813.4	3/4"	60	580	1
48113.16	13/16"	60	585	1

**1"DR. Square impact deep socket**

<b>48190</b>		<i>l</i>		
Part no.	Socket	mm	g	pc/box
4819017	17	90	780	1
4819019	19	90	850	1
4819021	21	90	990	1
4819011.16	11/16"	90	770	1
481903.4	3/4"	90	850	1
4819013.16	13/16"	90	980	1



**1"DR. Truck nut impact socket**

<b>482</b>			<i>l</i>		
Part no.	Socket	middle	mm	g	pc/box
48217	17	76	684	1	
482175	17.5	76	684	1	
48219	19	76	712	1	
48220	20	76	712	1	
482205	20.5	76	712	1	
48221	21	76	694	1	
482215	21.5	76	693	1	
48222	22	76	692	1	
48211.16	11/16"	76	684	1	
4823.4	3/4"	76	712	1	
48213.16	13/16"	76	694	1	
4827.8	7/8"	76	694	1	





**1"DR. Rear wheel nut socket**

<b>484</b>			<i>l</i>		
Part no.	Socket	middle	mm	g	pc/box
4843517	35	17	100	1168	1
4843820	38	20	100	1260	1
4844121	41	21	100	1326	1
4843820S	1-1/2"	13/16"	100	1260	1



**1"DR. 6pt. Flank impact socket**

<b>485</b>		<i>l</i>		
Part no.	Socket	mm	g	pc/box
48519	19	58	640	1
48520	20	58	630	1
48521	21	58	628	1
48522	22	58	628	1
48523	23	58	644	1
48524	24	58	644	1
48525	25	58	636	1
48526	26	58	634	1
48527	27	58	632	1
48528	28	58	642	1
48529	29	58	660	1
48530	30	60	656	1
48532	32	60	664	1
48533	33	60	664	1
48534	34	62	694	1
48535	35	62	674	1
48536	36	65	684	1
48537	37	65	658	1
48538	38	65	674	1
48541	41	67	760	1
48542	42	70	760	1
48543	43	75	844	1
48544	44	75	928	1
48545	45	75	990	1
48546	46	75	1124	1

<b>485</b>		<i>l</i>		
Part no.	Socket	mm	g	pc/box
48547	47	75	1015	1
48548	48	75	1065	1
48550	50	75	1081	1
48552	52	75	1096	1
48554	54	80	1242	1
48555	55	80	1238	1
48558	58	85	1422	1
48560	60	85	1748	1
48563	63	85	1864	1
48565	65	85	1642	1
48567	67	90	1642	1
48570	70	90	1690	1
48571	71	95	2620	1
48572	72	95	2820	1
48575	75	95	2532	1
48577	77	100	2598	1
48580	80	100	2774	1
48585	85	105	4330	1
48590	90	105	3412	1
48595	95	105	4400	1
4853.4	3/4"	58	665	1
48513.16	13/16"	58	665	1
4857.8	7/8"	58	660	1
48515.16	15/16"	58	660	1
4851.0	1"	58	650	1
4851.1.16	1-1/16"	58	655	1
4851.1.8	1-1/8"	58	655	1
4851.3.16	1-3/16"	60	670	1
4851.1.4	1-1/4"	60	670	1
4851.5.16	1-5/16"	62	675	1
4851.3.8	1-3/8"	62	675	1
4851.7.16	1-7/16"	65	695	1
4851.1.2	1-1/2"	65	720	1
4851.9.16	1-9/16"	65	765	1
4851.5.8	1-5/8"	70	815	1
4851.11.16	1-11/16"	70	865	1
4851.3.4	1-3/4"	75	910	1
4851.13.16	1-13/16"	75	1015	1
4851.7.8	1-7/8"	75	1065	1
4851.15.16	1-15/16"	75	1085	1
4852.0	2"	75	1250	1
4852.1.16	2-1/16"	75	1370	1
4852.1.8	2-1/8"	80	1405	1
4852.3.16	2-3/16"	80	1565	1
4852.1.4	2-1/4"	85	1605	1
4852.5.16	2-5/16"	85	1675	1
4852.3.8	2-3/8"	85	1875	1
4852.7.16	2-7/16"	85	1980	1
4852.1.2	2-1/2"	85	2055	1
4852.9.16	2-9/16"	85	2170	1
4852.5.8	2-5/8"	90	2295	1
4852.11.16	2-11/16"	90	2425	1
4852.3.4	2-3/4"	90	2510	1
4852.13.16	2-13/16"	95	2745	1
4852.7.8	2-7/8"	95	2910	1
4852.15.16	2-15/16"	95	3590	1
4853.0	3"	100	3715	1
4853.1.16	3-1/16"	100	3840	1
4853.1.8	3-1/8"	100	3960	1
4853.1.4	3-1/4"	105	4185	1
4853.3.8	3-3/8"	105	4285	1
4853.1.2	3-1/2"	105	4485	1



**1"DR. 6pt. Flank impact middle deep socket**

**48580**

Part no.	Socket	l mm	g	pc/box
4858027	27	80	608	1
4858030	30	80	652	1
4858032	32	80	766	1
4858033	33	80	802	1
4858035	35	80	798	1
4858036	36	80	808	1
4858038	38	80	826	1
4858041	41	80	818	1



**1"DR. 6pt. Flank impact deep socket**

**485100**

Part no.	Socket	l mm	g	pc/box
48510024	24	100	932	1
48510026	26	100	932	1
48510027	27	100	952	1
48510029	29	100	994	1
48510030	30	100	1010	1
48510032	32	100	1096	1
48510033	33	100	1012	1
48510034	34	100	1044	1
48510035	35	100	1052	1
48510036	36	100	1148	1
48510038	38	100	1044	1
48510041	41	100	1158	1
48510046	46	100	1314	1
48510048	48	100	1362	1
48510050	50	100	1402	1
48510054	54	100	1570	1
48510055	55	100	1696	1
48510058	58	100	1856	1
48510060	60	100	1978	1
48512063	63	120	2120	1

Part no.	Socket	l mm	g	pc/box
485100				
48512065	65	120	2430	1
48512067	67	120	2550	1
48513570	70	135	2690	1
48513575	75	135	3684	1
48513577	77	135	4104	1
48510015.16	15/16"	100	885	1
4851001.0	1"	100	975	1
4851001.1.16	1-1/16"	100	1055	1
4851001.1.8	1-1/8"	100	1075	1
4851001.3.16	1-3/16"	100	1130	1
4851001.1.4	1-1/4"	100	1115	1
4851001.5.16	1-5/16"	100	1120	1
4851001.3.8	1-3/8"	100	1125	1
4851001.7.16	1-7/16"	100	1165	1
4851001.1.2	1-1/2"	100	1120	1
4851001.9.16	1-9/16"	100	1265	1
4851001.5.8	1-5/8"	100	1285	1
4851001.11.16	1-11/16"	100	1410	1
4851001.3.4	1-3/4"	100	1485	1
4851001.13.16	1-13/16"	100	1500	1
4851001.7.8	1-7/8"	100	1550	1
4851001.15.16	1-15/16"	100	1560	1
4851002.0	2"	100	1650	1
4851002.1.16	2-1/16"	100	1730	1
4851002.1.8	2-1/8"	100	1750	1
4851002.3.16	2-3/16"	100	1900	1
4851002.1.4	2-1/4"	100	1980	1
4851002.5.16	2-5/16"	100	2100	1
4851002.3.8	2-3/8"	100	2450	1



**1"DR. 12pt. Impact socket**

**488**

Part no.	Socket	l mm	g	pc/box
48850	50	75	1300	1
48855	55	80	1500	1
48865	65	85	1655	1



**1" Impact wrench with 9" extension**

<b>82581</b>	<b>l</b>		
Part no.	mm	kg	pc/box
82581	570mm-22.5"	13.0	1

**Specifications :**

Square Drive.....	1"
Free Speed (R.P.M.).....	5000
Max. Torque (Ft/Lbs) / (N-M)....	2000/2720
Air Pressure (PSI).....	90
AIR Inlet (P.T.).....	1/2"
Air Consumption (C.F.M.).....	10



**1"DR. Impact wrench (Mini type)**

<b>82587</b>	<b>l</b>		
Part no.	mm	kg	pc/box
82587	280mm-11.0"	5.8	1

**Specifications :**

Square Drive.....	1"
Free Speed (R.P.M.).....	4000
Max. Torque (Ft/Lbs) / (N-M)....	1350/1800
Air Pressure (PSI).....	90
AIR Inlet (P.T.).....	3/8"
Air Consumption (C.F.M.).....	6



**1"DR. Impact wrench**

<b>82585</b>	<b>l</b>		
Part no.	mm	kg	pc/box
82585	550mm-21.6"	12.5	1

**Specifications :**

Square Drive.....	1"
Free Speed (R.P.M.).....	4000
Max. Torque (Ft/Lbs) / (N-M)....	1800 / 2439
Air Pressure (PSI).....	90
AIR Inlet (P.T.).....	3/8"
Air Consumption (C.F.M.).....	9



**1"DR. Impact wrench**



<b>82588</b>	<b>l</b>		
Part no.	mm	kg	pc/box
82588	365mm-14.4"	11	1

**Specifications :**

Square Drive.....	1"
Free Speed (R.P.M.).....	3800
Max. Torque (Ft/Lbs) / (N-M)....	1844 / 2500
Air Pressure (PSI).....	90
AIR Inlet (P.T.).....	3/8"
Air Consumption (C.F.M.).....	9



**1"DR. Impact wrench with 6" extension**



<b>82589</b>	<b>l</b>		
Part no.	mm	kg	pc/box
82589	515mm-20.3"	12	1

**Specifications :**

Square Drive.....	1"
Free Speed (R.P.M.).....	3800
Max. Torque (Ft/Lbs) / (N-M)....	1844 / 2500
Air Pressure (PSI).....	90
AIR Inlet (P.T.).....	3/8"
Air Consumption (C.F.M.).....	9



**1"DR. Impact wrench with 6" extension**



<b>825811</b>	<b>l</b>		
Part no.	mm	kg	pc/box
825811	500mm-19.7"	7.6	1

**Specifications :**

Square Drive.....	1"
Free Speed (R.P.M.).....	4000
Max. Torque (Ft/Lbs) / (N-M)....	1328 / 1800
Air Pressure (PSI).....	90
AIR Inlet (P.T.).....	3/8"
Air Consumption (C.F.M.).....	7



**1"DR. Impact wrench**



<b>825810</b>	<b>l</b>		
Part no.	mm	kg	pc/box
825810	350mm-13.8"	6.6	1

**Specifications :**

Square Drive.....	1"
Free Speed (R.P.M.).....	4000
Max. Torque (Ft/Lbs) / (N-M)....	1328 / 1800
Air Pressure (PSI).....	90
AIR Inlet (P.T.).....	3/8"
Air Consumption (C.F.M.).....	7



**1"DR. Impact wrench**

<b>825812</b>	<b>l</b>		
Part no.	mm	kg	pc/box
825812	365mm-14.4"	11	1

**Specifications :**

Square Drive.....	1"
Free Speed (R.P.M.).....	3800
Max. Torque (Ft/Lbs) / (N-M)....	1844 / 2500
Air Pressure (PSI).....	90
AIR Inlet (P.T.).....	3/8"
Air Consumption (C.F.M.).....	9



**1"DR. Impact wrench with 6" extension**

<b>825813</b>	<b>l</b>		
Part no.	mm	kg	pc/box
825813	515mm-20.3"	12	1



**1"DR. Universal joint (pin type)**

<b>80581MPP</b>	<b>l</b>		
Part no.	mm	g	pc/box
80581MPP	135	1626	1

**Specifications :**

- Square Drive..... 1"
- Free Speed (R.P.M.)..... 3800
- Max. Torque (Ft/Lbs) / (N-M).... 1844/2500
- Air Pressure (PSI)..... 90
- AIR Inlet (P.T.)..... 3/8"
- Air Consumption (C.F.M.)..... 9



**1"DR. Universal joint (ball type)**

<b>80581MPB</b>	<b>l</b>		
Part no.	mm	g	pc/box
80581MPB	135	1626	1



**1"DR. Impact extension (Pin type)**

<b>8048..MPP</b>	<b>l</b>		
Part no.	mm	g	pc/box
8048100MPP	100-4"	935	2
8048175MPP	175-7"	1476	2
8048250MPP	250-10"	1961	2
8048330MPP	330-13"	2702	1
8048100MPB	100-4"	935	2
8048175MPB	175-7"	1476	2
8048250MPB	250-10"	2050	2
8048330MPB	330-13"	2578	1



**1"DR. Adaptor (pin type)**

<b>8098..MPP</b>		<b>l</b>		
Part no.	Size	mm	g	pc/box
80986MPP	1"(F)x3/4"(M)	75	1070	1
809812MPP	1"(F)x1-1/2"(M)	80	1506	1





**1"DR. Adaptor (ball type)**

<b>8098..MPB</b>				
Part no.	Size	mm	g	pc/box
80986MPB	1"(F)x3/4"(M)	75	596	2





**O-ring & Pin for 1"DR.**



Part no.	mm	mm	g	pc/box
R4455	∅44- ∅5.5		4	50
P4550		45L- ∅5.0	4	50
R7555	∅75- ∅5.5		4	50
P7550		75L- ∅5.0	4	50



**#5 Spline Drive  
6pt. Flank impact socket**



<b>455</b>		<i>l</i>		
Part no.	Socket	mm	g	pc/box
45522	22	57	660	1
45524	24	57	655	1
45525	25	57	655	1
45527	27	57	650	1
45529	29	57	660	1
45530	30	60	670	1
45532	32	60	670	1
45533	33	60	675	1
45535	35	62	680	1
45538	38	62	725	1
45540	40	62	770	1
45541	41	62	815	1
45546	46	70	1015	1
45548	48	70	1065	1
45550	50	70	1210	1
4557.8	7/8"	57	660	1
45515.16	15/16"	57	660	1
4551.0	1"	57	650	1
4551.1.16	1-1/16"	57	655	1
4551.1.8	1-1/8"	57	655	1
4551.3.16	1-3/16"	60	670	1
4551.1.4	1-1/4"	60	670	1
4551.5.16	1-5/16"	62	675	1
4551.3.8	1-3/8"	62	675	1
4551.7.16	1-7/16"	62	695	1
4551.1.2	1-1/2"	62	720	1
4551.9.16	1-9/16"	62	765	1
4551.5.8	1-5/8"	62	815	1
4551.11.16	1-11/16"	62	865	1
4551.3.4	1-3/4"	70	910	1
4551.13.16	1-13/16"	70	1015	1
4551.7.8	1-7/8"	70	1065	1
4551.15.16	1-15/16"	70	1085	1
4552.0	2"	70	1250	1
4552.1.4	2-1/4"	75	1605	1



**#5 Spline Drive Adaptor (pin type)**

<b>809..MPP</b>		<i>l</i>		
Part no.	size	mm	g	pc/box
80956MPP	#5(F)x3/4"(M)	85	700	1
80958MPP	#5(F)x1"(M)	95	850	1
80985MPP	1"(F)x#5(M)	100	950	1



**1-1/2" DR. 6pt. Flank impact socket**

<b>4125</b>		<i>l</i>		
Part no.	Socket	mm	kg	pc/box
412541	41	80	2.23	1
412542	42	80	2.25	1
412546	46	84	2.34	1
412550	50	84	2.39	1
412552	52	84	2.45	1
412554	54	84	2.37	1
412555	55	90	2.51	1
412558	58	90	2.32	1
412560	60	90	2.65	1
412565	65	95	2.99	1
412570	70	100	3.41	1
412575	75	105	3.66	1
412580	80	110	4.55	1
412585	85	110	5.65	1
412590	90	112	5.69	1
412595	95	112	9.24	1

<b>4125</b>		<i>l</i>		
Part no.	Socket	mm	kg	pc/box
4125100	100	115	9.91	1
4125105	105	120	11.00	1
4125110	110	124	12.64	1
4125115	115	128	12.96	1
4125120	120	132	14.74	1
4125125	125	136	16.10	1
4125130	130	140	16.74	1
4125135	135	125	18.98	1
4125140	140	150	19.62	1
4125150	150	160	23.00	1
41251.5.8	1-5/8"	80	2.23	1
41251.11.16	1-11/16"	80	2.25	1
41251.3.4	1-3/4"	80	2.34	1
41251.13.16	1-13/16"	84	2.39	1
41251.15.16	1-15/16"	84	2.45	1
41252.0	2"	84	2.37	1
41252.1.16	2-1/16	84	2.51	1
41252.1.8	2-1/8"	84	2.32	1
41252.3.16	2-3/16	90	2.65	1
41252.1.4	2-1/4"	90	2.66	1
41252.5.16	2-5/16"	90	2.76	1
41252.3.8	2-3/8"	90	2.80	1
41252.7.16	2-7/16"	95	2.85	1
41252.1.2	2-1/2"	95	2.89	1
41252.9.16	2-9/16"	95	2.99	1
41252.5.8	2-5/8"	100	3.22	1
41252.11.16	2-11/16"	100	3.41	1
41252.3.4	2-3/4"	100	3.43	1
41252.13.16	2-13/16"	105	3.46	1
41252.7.8	2-7/8"	105	3.56	1
41252.15.16	2-15/16"	105	3.66	1
41253.0	3"	105	4.35	1
41253.1.8	3-1/8"	110	4.55	1
41253.1.4	3-1/4"	110	4.55	1
41253.3.8	3-3/8"	110	5.65	1
41253.1.2	3-1/2"	112	5.69	1
41253.5.8	3-5/8"	112	9.02	1
41253.3.4	3-3/4"	112	9.24	1
41253.7.8	3-7/8"	115	9.91	1
41254.0	4"	120	10.23	1
41254.1.8	4-1/8	120	10.89	1
41254.1.4	4-1/4"	124	11.00	1
41254.1.2	4-1/2"	128	12.96	1
41254.5.8	4-5/8"	132	14.64	1
41254.3.4	4-3/4"	132	14.74	1
41254.7.8	4-7/8"	136	16.10	1
41255.0	5"	140	16.74	1
41255.1.4	5-1/4"	145	18.98	1
41256.0	6"	165	23.00	1
41256.1.2	6-1/2"	175	26.00	1



**1-1/2"DR. Impact extension (Pin type)**

<b>80412..MPP</b>	<i>l</i>		
Part no.	mm	kg	pc/box
80412175MPP	175-7"	3.30	1
80412250MPP	250-10"	4.96	1
80412330MPP	330-13"	5.20	1

**1-1/2"DR. 6pt. Flank impact deep socket**

<b>4125D</b>		<i>l</i>		
Part no.	Socket	mm	kg	pc/box
4125D41	41	115	3.00	1
4125D42	42	115	3.00	1
4125D46	46	125	3.40	1
4125D50	50	135	3.80	1
4125D54	54	135	4.00	1
4125D55	55	135	4.10	1
4125D60	60	135	4.30	1
4125D65	65	145	5.20	1
4125D70	70	145	5.70	1
4125D75	75	155	6.50	1
4125D80	80	165	7.20	1
4125D85	85	165	7.40	1
4125D90	90	175	9.40	1
4125D95	95	175	10.00	1
4125D100	100	185	10.50	1
4125D105	105	195	11.00	1
4125D110	110	195	11.50	1
4125D115	115	195	12.00	1
4125D120	120	205	13.00	1
4125D125	125	205	14.00	1
4125D130	130	205	15.00	1
4125D1.5.8	1-5/8"	115	3.00	1
4125D1.11.16	1-11/16"	115	3.10	1
4125D1.3.4	1-3/4"	115	3.20	1
4125D1.13.16	1-13/16"	125	3.40	1
4125D1.7.8	1-7/8"	125	3.50	1
4125D1.15.16	1-15/16"	125	3.60	1
4125D2.0	2"	135	3.80	1
4125D2.1.16	2-1/16"	135	3.90	1
4125D2.1.8	2-1/8"	135	4.00	1
4125D2.3.16	2-3/16"	135	4.10	1
4125D2.1.4	2-1/4"	135	4.20	1
4125D2.3.8	2-3/8"	135	4.30	1
4125D2.7.16	2-7/16"	135	4.40	1
4125D2.1.2	2-1/2"	135	4.60	1
4125D2.9.16	2-9/16"	145	5.20	1
4125D2.5.8	2-5/8"	145	5.30	1
4125D2.11.16	2-11/16"	154	5.50	1
4125D2.3.4	2-3/4"	145	5.70	1
4125D2.13.16	2-13/16"	145	5.90	1
4125D2.7.8	2-7/8"	145	6.10	1
4125D2.15.16	2-15/16"	155	6.50	1
4125D3.0	3"	155	6.80	1
4125D3.1.8	3-1/8"	165	7.50	1
4125D3.3.4	3-3/4"	175	10.00	1
4125D3.7.8	3-7/8"	175	11.00	1



**1-1/2"DR. Adaptor (Pin type)**

<b>80912..MPP</b>	<i>l</i>			
Part no.	size	mm	kg	pc/box
809128MPP	1-1/2"(F)x1"(M)	98	2.47	1
8091220MPP	1-1/2"(F)x2-1/2"(M)	115	3.80	1



**1-1/2"DR. Impact wrench**

<b>825121</b>	<i>l</i>		
Part no.	mm	kg	pc/box
825121	390mm-15.4"	11.3	1

**Specifications :**

Square Drive.....	1-1/2"
Free Speed (R.P.M.).....	3700
Max. Torque (Ft/Lbs) / (N-M)....	2025 / 2700
Air Pressure (PSI).....	90
AIR Inlet (P.T.).....	3/8"
Air Consumption (C.F.M.).....	9



**2-1/2" DR. 6pt. Flank impact socket**

<b>4205</b>		<i>l</i>		
Part no.	Socket	mm	kg	pc/box
420550	50	115	7.20	1
420555	55	115	7.30	1
420560	60	125	7.50	1
420565	65	125	7.60	1
420570	70	125	7.70	1
420575	75	125	7.80	1
420580	80	125	7.90	1
420585	85	132	8.00	1
420590	90	132	8.30	1
420595	95	140	10.00	1
4205100	100	142	11.00	1
4205105	105	146	11.50	1
4205110	110	155	12.00	1
4205115	115	158	13.50	1
4205120	120	160	15.00	1
4205125	125	165	16.00	1
4205130	130	170	17.50	1
4205135	135	175	19.00	1
4205140	140	180	21.00	1
4205145	145	183	23.00	1
4205150	150	192	25.50	1
4205160	160	200	30.00	1
4205165	165	204	32.00	1
4205170	170	207	34.00	1
4205175	175	210	36.00	1
4205180	180	214	40.00	1
4205185	185	218	42.00	1
4205190	190	220	47.00	1
4205200	200	225	51.00	1
4205210	210	235	57.00	1
4205215	215	240	60.00	1
4205225	225	250	70.00	1
4205235	235	260	77.00	1
42052.3.8	2-3/8"	125	7.20	1
42052.7.16	2-7/16"	125	7.30	1
42052.1.2	2-1/2"	125	7.40	1
42052.9.16	2-9/16"	125	7.50	1
42052.5.8	2-5/8"	125	7.60	1
42052.11.16	2-11/16"	125	7.70	1
42052.3.4	2-3/4"	125	7.80	1
42052.13.16	2-13/16"	125	7.85	1
42052.7.8	2-7/8"	125	7.90	1
42052.15.16	2-15/16"	125	7.95	1
42053.0	3"	125	8.00	1
42053.1.8	3-1/8"	125	8.05	1
42053.1.4	3-1/4"	125	8.10	1
42053.3.8	3-3/8"	132	8.15	1

<b>4205</b>		<i>l</i>		
Part no.	Socket	mm	kg	pc/box
42053.5.8	3-5/8"	132	8.80	1
42053.3.4	3-3/4"	140	10.00	1
42053.7.8	3-7/8"	140	10.50	1
42054.0	4"	142	11.00	1
42054.1.8	4-1/8"	142	11.50	1
42054.1.4	4-1/4"	155	12.00	1
42054.1.2	4-1/2"	158	13.00	1
42054.5.8	4-5/8"	160	14.00	1
42054.7.8	4-7/8"	165	16.00	1
42055.0	5"	165	17.00	1
42055.1.4	5-1/4"	175	19.00	1
42055.3.8	5-3/8"	180	20.00	1
42055.1.2	5-1/2"	180	21.00	1
42055.5.8	5-5/8"	182	22.00	1
42055.3.4	5-3/4"	192	24.00	1
42056.0	6"	196	28.00	1
42056.1.8	6-1/8"	196	29.00	1
42056.5.8	6-5/8"	205	33.00	1
42057.0	7"	213	39.00	1



**2-1/2" DR. 6pt. Flank impact deep socket**

<b>4205D</b>		<i>l</i>		
Part no.	Socket	mm	kg	pc/box
4205D75	75	190	11.00	1
4205D80	80	190	12.00	1
4205D85	85	195	13.00	1
4205D90	90	205	14.00	1
4205D95	95	210	14.50	1
4205D100	100	215	15.00	1
4205D105	105	220	18.00	1
4205D110	110	225	19.00	1
4205D115	115	230	20.00	1
4205D120	120	235	24.00	1
4205D125	125	238	25.00	1
4205D130	130	243	26.00	1
4205D135	135	248	27.00	1
4205D140	140	248	28.00	1
4205D145	145	248	29.00	1
4205D150	150	255	30.00	1
4205D155	155	255	32.00	1
4205D160	160	260	35.00	1
4205D165	165	260	36.00	1
4205D170	170	265	37.00	1
4205D175	175	270	39.00	1





**2-1/2"DR. Impact extension (Pin type)**

<b>80420..MPP</b>	<i>l</i>		
Part no.	mm	kg	pc/box
80420250MPP	250-10"	18.00	1
80420500MPP	500-20"	27.00	1



**2-1/2"DR. Adaptor (Pin type)**

<b>80920..MPP</b>		<i>l</i>		
Part no.	size	mm	kg	pc/box
8092012MPP	2-1/2"(F)x1-1/2"(M)	145	7.20	1

**3-1/2"DR. 6pt. Flank impact socket**

<b>4285</b>		<i>l</i>		
Part no.	Socket	mm	kg	pc/box
4285105	105	176	19.00	1
4285110	110	179	20.00	1
4285115	115	183	21.00	1
4285120	120	185	22.00	1
4285125	125	190	23.00	1
4285130	130	194	25.00	1
4285135	135	200	27.00	1
4285140	140	205	28.00	1
4285145	145	207	30.00	1
4285150	150	212	31.00	1
4285155	155	218	33.00	1
4285160	160	220	35.00	1
4285165	165	224	38.00	1
4285170	170	227	39.00	1
4285175	175	230	41.00	1
4285180	180	234	45.00	1
4285185	185	238	50.00	1
4285190	190	240	54.00	1
4285200	200	245	59.00	1
4285210	210	255	65.00	1
4285215	215	260	68.00	1
4285225	225	270	76.00	1
4285235	235	280	80.00	1



**Suitcase with 30 pcs of tools**

**50234-30**

Part no.



1/16.5/17.8/1'



16.5kg

**Content:**



827A31	1- Cordless drill (charger included)
66303	1- Hacksaw 315mmL
5096P803	1- Measuring tape 3M
21111	11pc bit combination set
12125 0...3	Phillips PH.0; PH.1; PH.2; PH.3
122250 0...3	Pozidriv PZ.0; PZ.1; PZ.2; PZ.3
12325 055...065	Slotted 5.5; 6.5 mm
81260Q	Magnetic quick-release bit holder



711 1N...2N	2-Insulated phillips screwdriver PH.1; PH.2
713 03N...065N	4-Insulated slotted screwdriver 3; 4; 5.5; 6.5 mm
6982	1-Technician's scissors 145mmL
88404	1-Screwdriver probe 110~250V AC voltage tester
5055P4	1-Utility knife (incl. 2pc blades)



649250A	1-Adjustable gauged wrench 10" (250mmL)
6904160	1-Insulated long nose pliers 6"
6903180	1-Insulated combination pliers 7"
6905160	1-Insulated diagonal cutting pliers 6"
6912160	1-Insulated wire stripper pliers 6"
6907250	1-Insulated water pump pliers 10" (Curved jaw)



**1/2"DR. Cordless impact wrench**

**825A41**



Part no.

4/24.5/25.5/2.69'

3kg

**Specifications :**

Square Drive..... 13mm  
 Free Speed (R.P.M.)..... 2000  
 Max. Torque (ft-lb) / (kg-cm)..... 300/4100

Impacts Per Minute..... 2600  
 Voltage (V d.c.)..... 19.2  
 Charging Time (Hour)..... 1 hour (AUTO CUT-OFF)  
 Capability..... A fully charged battery pack can tighten and loose 150 pcs of 21mm wheel nut

\*Charger included



**4-1/2" Cordless angle grinder**

**826A01**



Part no.

4/21.0/22.0/3'

2.2kg

**Specifications :**

Square Drive..... 6.35mm  
 Free Speed (R.P.M.)..... 7000  
 Voltage (V d.c.)..... 19.2

Wheel Size..... 4-1/2"

\*Charger included



**Cordless drill**

<b>827A31</b>		
Part no.	6/24.2/25.2/2.5'	1kg

**Specifications :**



Free Speed (R.P.M.)..... Low: 0-325  
 High: 0-1170  
 Max. Torque (in-lb) / (kg-cm)..... 300 / 350  
 Voltage (V d.c.)..... 14.4

Charging Time (Hour)..... 1 hour (AUTO CUT-OFF)  
 Clutch..... 17 Sections  
 Capability..... A fully charged battery pack can tighten 300 pcs of 4.1x38mmL carpenter screw to a pine board  
 Chuck Capability..... Keyless 10mm

\*Charger included



**1/4" Cordless impact screwdriver**

<b>828A21</b>		
Part no.	10/16.0/17.0/2.4'	0.4kg

**Specifications :**

Free Speed (R.P.M.)..... Low: 220  
 High: 450  
 Max. Torque (kg-cm)..... Electrically: 40  
 Manually: 250  
 Voltage (V d.c.)..... 3.6

Capability..... A fully charged battery pack can tighten 75 pcs of TP4x20mmL carpenter screw to a pine board  
 Charging Time (Hour)..... 1 hour (AUTO CUT-OFF)

\*Charger included



**1/4" Cordless impact driver**

<b>828A22</b>		
Part no.	6/25.8/26.8/2.5'	1.7kg

**Specifications :**

Free Speed (R.P.M.)..... 0-2300  
 Max. Torque (ft-lb) / (kg-cm)..... 72/1000  
 Impacts Per Minute..... 3000  
 Voltage (V d.c.)..... 12

Capability..... A fully charged battery pack can tighten 170 pcs of 4.1x38mmL carpenter screw to a pine board  
 Charging Time (Hour)  
 Charging Time (Hour)..... 1 hour (AUTO CUT-OFF)

\*Charger included



# General Information

This catalogue replaces all previous editions.  
All rights reserved in all countries.  
Reprinting, excerpts, require the previous permission in writing by Shyang Yun Hardware Co., Ltd.

The photographs and the technical details are of the articles at present offered.

Since we are constantly updating and improving our products to meet user needs and technological developments, we reserve the right to make modifications and changes with regard to photographs, specifications, sizes, packing, weights and performance without notice.

There is no liability for printing errors and correction or replacement supplies with regard to products already delivered.  
Cancellations of all models and sets may be made at any time without there being any grounds for legal claim.

FORCE is the registered trademark.

All contents are Copyright ©  
Shyang Yun Hardware Co., Ltd. All rights reserved.

# More Catalogues...

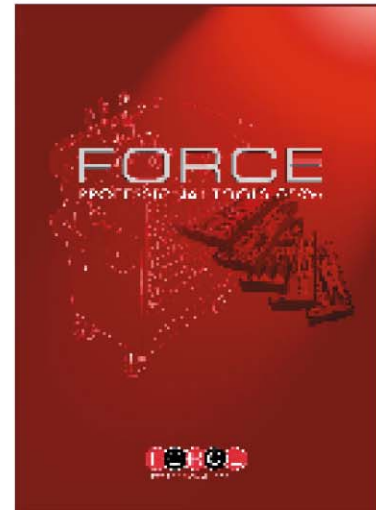

**Trolley System**



**FORCE CABIN II**

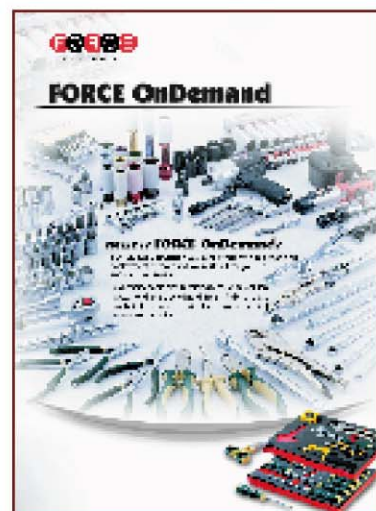

**FORCE OnDemand**



FORCE TAIWAN

SHYANG YUN HARDWARE CO., LTD.

No. 15-6, Shi Pyng South Lane, 407 Taichung, Taiwan

Tel:+886-4-24610088 Fax:+886-4-24615856

Website : <http://www.force.com.tw>

E-mail: [info@force.com.tw](mailto:info@force.com.tw)



V7/June, 2006

FORCE

GENERAL CATALOGUE 06/07