

# FORCE

TOOL STORAGE 08/09



FORCE®



**FORCE OnDemand**

**Page**  
1-1~1-13



**Toolbags, Suitcases, Tool Boxes**

**Page**  
2-1 ~ 2-34



**Workbenches, Trolleys, Cart**

**Page**  
3-1~3-44



**Details of Tool Sets**

**Page**  
4-1~4-46



**FORCE CABIN II**

**Page**  
5-1~5-24

# What is FORCE OnDemand ?

**FORCE OnDemand** is You make your own selection and deployment of tools and we realize it for you. This is 100% customization.

Every mechanic and technician has different job focus. And every one has different habit of using tools. Let the tool sets adapted to you instead of you being adapted.

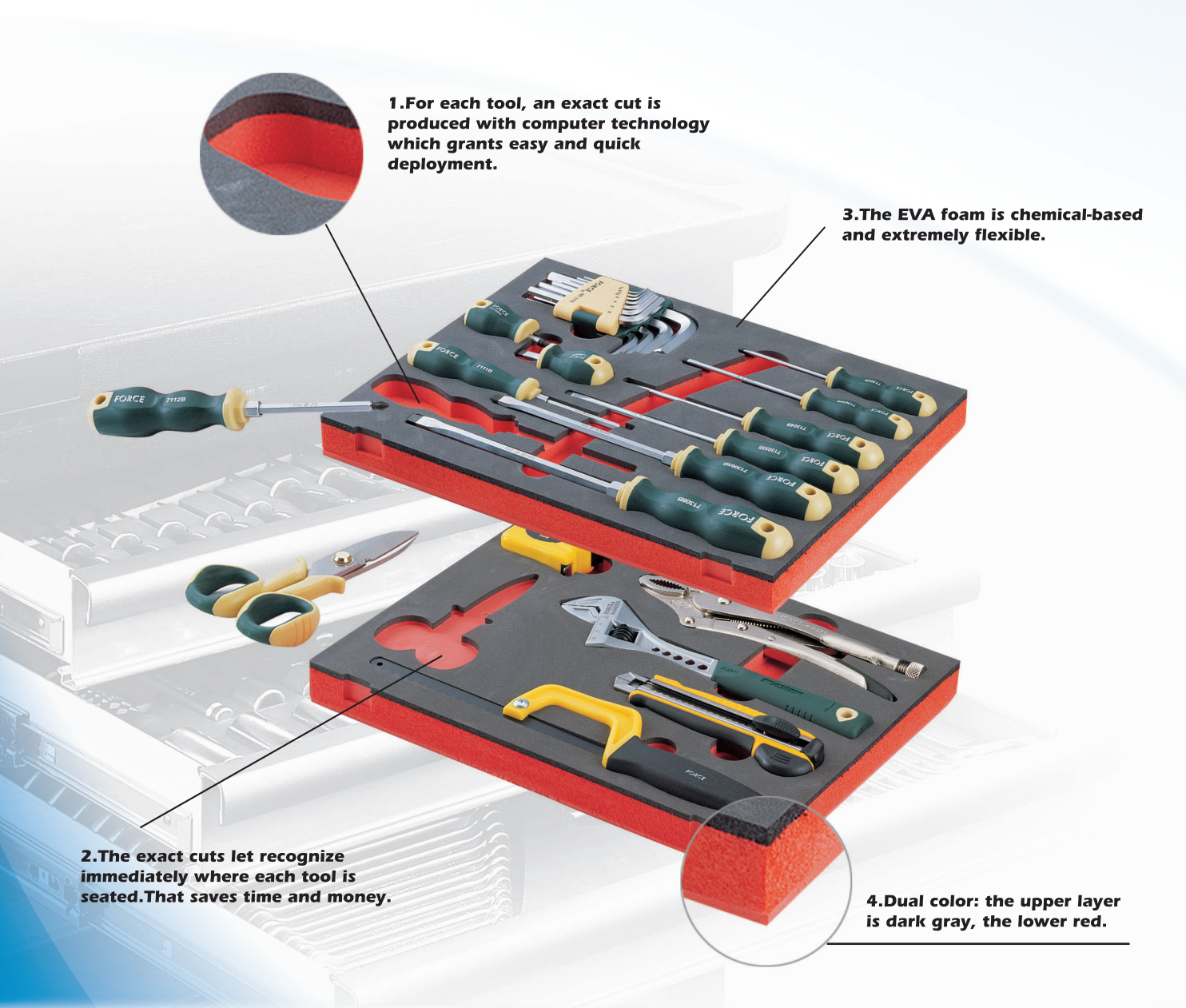

1. For each tool, an exact cut is produced with computer technology which grants easy and quick deployment.

3. The EVA foam is chemical-based and extremely flexible.

2. The exact cuts let recognize immediately where each tool is seated. That saves time and money.

4. Dual color: the upper layer is dark gray, the lower red.

## 259pc tool set for trolley 102/106 series!

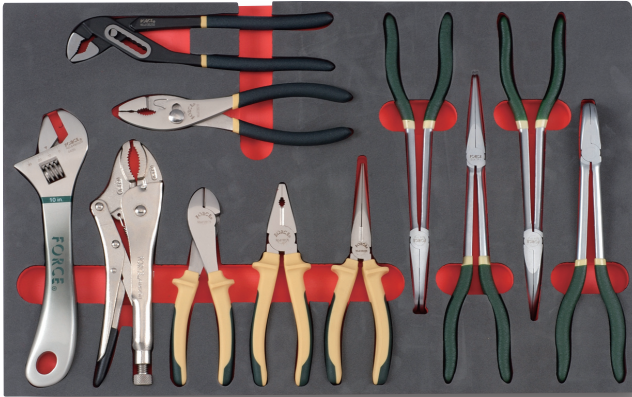

### 1 NO.5117

#### 11pc Pliers set

- Adjustable wrench 10"
- Waterpump pliers 10"
- Locking pliers 10"
- Long nose straight pliers 11"
- Long nose 45 de. pliers 11"
- Long nose 90 de. pliers 11"
- Multi-purpose 4 points gripping pliers 11"
- Long Nose pliers 8"
- Combination pliers 7"
- Diagonal pliers 7"
- Slip joint pliers 8.5"

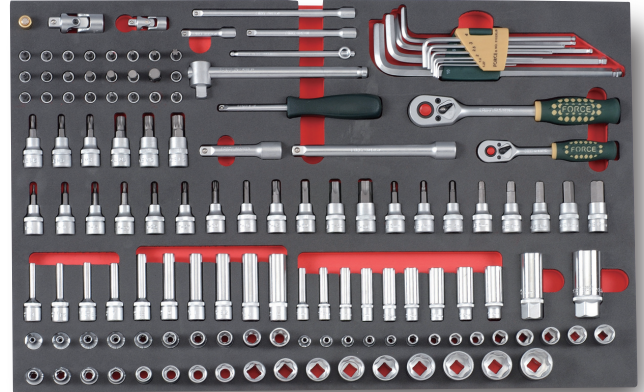

### 3 NO.31351

#### 135pc 1/4" & 3/8"DR. Combination set

- socket
  - 1/4", 3.2; 4; 4.5; 5; 5.5; 6; 7; 8; 9; 10; 11; 12; 13; 14 mm
  - 1/4", Deep 5; 6; 7; 8; 9; 10; 11; 12; 13 mm
  - ⊕ 3/8", E4; E5; E6; E7; E8; E10; E11; E12; E14; E16
  - ⊕ 3/8", Deep E4; E5; E6; E7; E8; E10; E11; E12; E14; E16
  - 3/8", 6; 7; 8; 9; 10; 11; 12; 13; 14; 15; 16; 17; 18; 19; 20; 21; 22 mm
- socket bit
  - 1/4", 3; 4; 5; 6; 7; 8; 10 mm
  - ⊕ 1/4", PH.1; PH.2; PH.3
  - ⊕ 1/4", PZ.1; PZ.2; PZ.3
  - 1/4", 4; 5.5; 6.5 mm
  - ⊕ 1/4", T8; T10; T15; T20; T25; T27; T30; T40
  - ⊕ 3/8", T-8H; T-10H; T-15H; T-20H; T-25H; T-27H; T-30H; T-40H; T-45H; T-50H; T-55H; T-60H
  - 3/8", M5; M6; M8; M9; M10; M12
  - 3/8", 3; 4; 5; 6; 7; 8; 10; 12 mm
- Hex key
  - 1.27; 1.5; 2; 2.5; 3; 4; 5; 6; 8; 10 mm
- Ratchet handle 1/4" & 3/8"
- Extension 1/4": 2" & 4" & 6"
- 3/8": 3" & 6"
- Sliding T handle 1/4" & 3/8"
- Universal joint 1/4" & 3/8"
- Spinner 6"
- Magnetic socket pick-up
- Spark plug socket 3/8" 16 & 20.6 mm

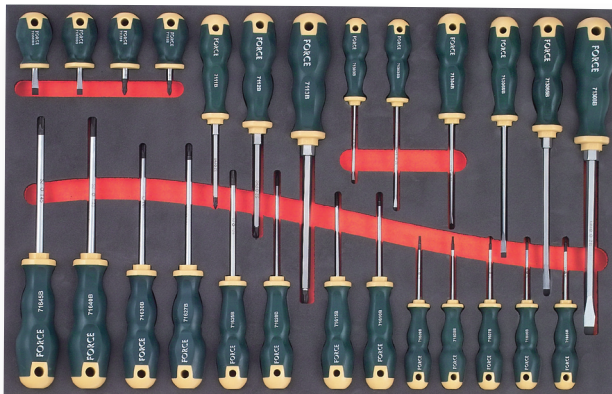

### 2 NO.2262

#### 26pc Screwdriver set

- Sizes:
- 3; 3.5; 4; 5.5; 6.5; 8 mm
  - Short 5.5; 6.5 mm
  - ⊕ PH.1; PH.2; PH.3
  - ⊕ Short PH.1; PH.2
  - ⊕ T5; T6; T7; T8; T9; T10; T15; T20; T25; T27; T30; T40; T45

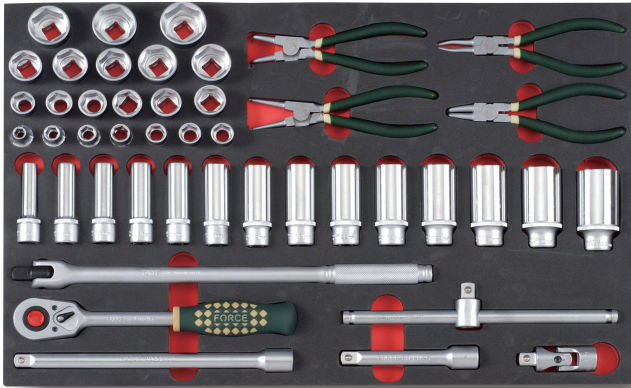

## 4 NO.4451

### 45pc 1/2"DR. Combination set

socket

- 1/2", 8; 10; 11; 12; 13; 14; 15; 16; 17; 18; 19; 20; 21; 22; 23; 24; 26; 27; 28; 30; 32 mm
- 1/2", Deep 10; 12; 13; 14; 15; 17; 19; 21; 22; 23; 24; 27; 30; 32 mm
- 1/2" Ratchet handle
- 1/2" Extension 125mmL & 250mmL
- 1/2" Sliding T handle
- 1/2" Universal joint
- 1/2" Swivel handle 15"
- Snap ring pliers
  - External straight tip 1.8mm (open)
  - Internal straight tip 1.8mm (close)
  - External 90° Bent tip 1.8mm (open)
  - Internal 90° Bent tip 1.8mm (close)

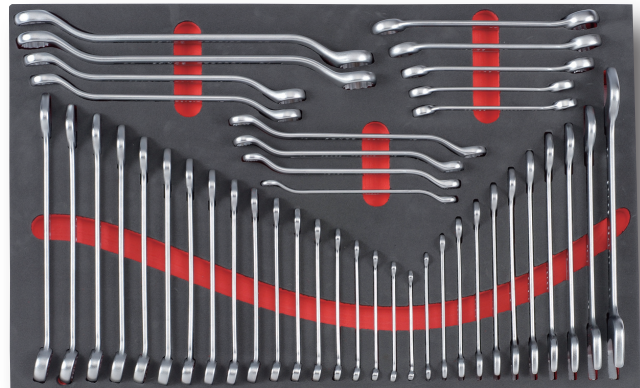

## 5 NO.5421

### 42pc Spanner set

- 45° offset ring wrench
  - 8x9; 10x11; 12x13; 14x15; 16x17; 18x19; 21x23; 22x24 mm
- Double open end wrench
  - 6x7; 8x9; 10x11; 12x13; 14x15; 16x17; 18x19; 20x22; 21x23; 24x27; 30x32 mm
- Combination wrench
  - 6; 7; 8; 9; 10; 11; 12; 13; 14; 15; 16; 17; 18; 19; 20; 21; 22; 23 mm
- Flare nut wrench
  - 9x11; 10x12; 12x14; 14x17; 17x19 mm



## 237pc tool set for trolley 102/106 series!

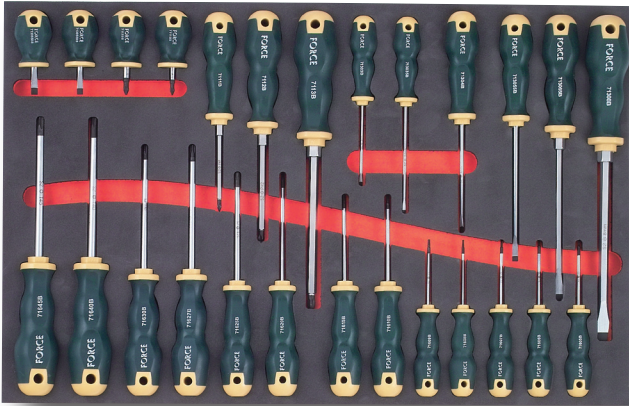

### 1 NO.2262

#### 26pc Screwdriver set

- Sizes:**
- 3; 3.5; 4; 5.5; 6.5; 8 mm
  - Short 5.5; 6.5 mm
  - PH.1; PH.2; PH.3
  - Short PH.1; PH.2
  - T5; T6; T7; T8; T9; T10; T15; T20; T25; T27; T30; T40; T45

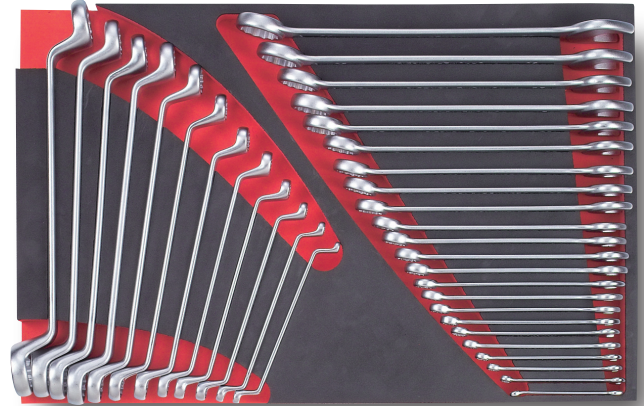

### 3 NO.5351

#### 35pc Wrench set

- |                    |   |
|--------------------|---|
| combination wrench | 6; 7; 8; 9; 10; 11; 12; 13; 14; 15; 16; 17; 18; 19; 21; 22; 23; 24; 26; 27; 28; 30; 32 mm |
| 75° ring wrench    | 6x7; 8x9; 10x11; 12x13; 14x15; 16x17; 18x19; 21x22; 23x26; 24x27; 25x28; 30x32            |

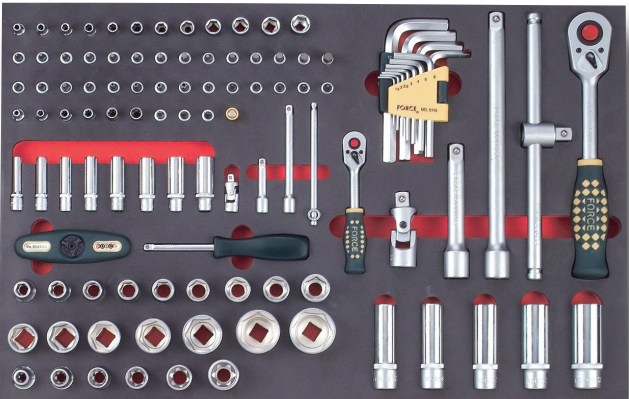

### 2 NO.41083

#### 108pc 1/4" & 1/2" DR. Combination set

- Sizes:**
- 1/4", 4; 4.5; 5; 5.5; 6; 7; 8; 9; 10; 11; 12; 13 mm
  - 1/4", Deep 6; 7; 8; 9; 10; 11; 12; 13 mm
  - 1/4", E4; E5; E6; E7; E8; E10
  - 1/2", 10; 11; 12; 13; 14; 15; 16; 17; 18; 19; 21; 22; 24; 27; 30; 32 mm
  - 1/2", Deep 14; 15; 17; 19; 22 mm
  - 1/2", E12; E14; E16; E18; E20; E24
- socket bit**
- 1/4", PH.1; PH.2; PH.3
  - 1/4", PZ.1; PZ.2; PZ.3
  - 1/4", 4; 5.5; 6.5 mm
  - 1/4", 3; 4; 5; 6; 7; 8 mm
  - 1/4", T8; T10; T15; T20; T25; T27; T30; T40
  - 1/4", T-8H; T-10H; T-15H; T-20H; T-25H; T-27H; T-30H; T-40H
- Hex key**
- 1.5; 2; 2.5; 3; 4; 5; 6; 7; 8; 10; 12 mm
- Ratchet handle 1/4" & 1/2"  
 T mini ratchet handle  
 Sliding T handle 1/4" & 1/2"  
 Extension 1/4": 2" & 4"  
 1/2": 5" & 10"  
 Spinner  
 Universal joint 1/4" & 1/2"  
 Magnetic socket pick-up

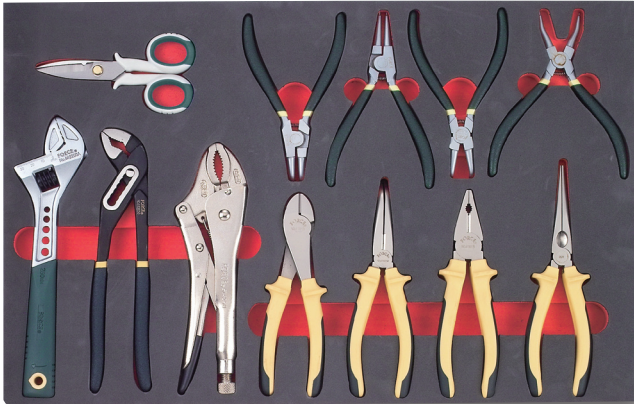

## 4 NO.51217

### 12pc Pliers set

- Long nose pliers 8"
- Bent long nose pliers 8"
- Combination pliers 7"
- Diagonal pliers 7"
- Locking pliers 10"
- Waterpump pliers 10"
- Snap ring pliers
  - External straight tip 1.8mm (open)
  - Internal straight tip 1.8mm (close)
  - External 90° bent tip 1.8mm (open)
  - Internal 90° bent tip 1.8mm (close)
- Adjustable gauged wrench 10"
- Technician's scissors 145mmL



## 6 NO.6213

### 21pc 3/4" DR. Socket set

- socket
  - 3/4", 19; 21; 22; 23; 24; 26; 27; 29; 30; 32; 35; 36; 38; 41; 46; 50 mm
- extension 3/4", 4" & 8"
- Telescope adjustable handle 800mmL
- 40 teeth Ratchet handle 150mmL
- Adaptor for sliding T handle



## 5 NO.5182

### 18pc Chisel & hammer set

- chisel 12; 15; 19; 22 mm
- cape chisel
- pin punch 2; 3; 4; 5; 6; 8 mm
- taper punch 5 mm
- center punch 6 mm



## 7 NO.4175

### 17pc 1/2" DR. Impact tool set

- impact socket
  - 1/2", 13; 14; 15; 16; 17; 18; 19; 21; 22; 24 mm
- colored impact socket Wheel nut 6pt. flank impact socket
  - 1/2", 17; 19; 21 mm
- Torque wrench 40-210Nm
- Cordless impact wrench (charger incl.)
- Wheel balancing weight tool

## Optional tool sets for trolley 102/106 series!

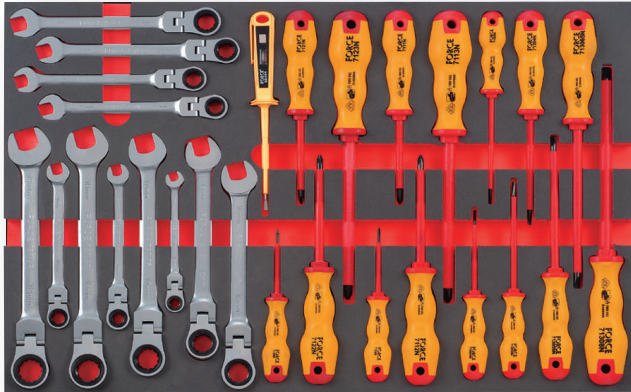

### 1 NO.2282

#### 28pc Insulated screwdriver and gear wrench

Flexible gear wrench 8; 9; 10; 11; 12; 13; 14; 15; 16; 17; 18; 19 mm  
 Insulated slotted screwdriver 2.4; 3; 3.5; 4; 5.5; 6.5; 8 mm  
 Insulated phillips screwdriver PH.0; PH.1; PH.2; PH.3  
 Insulated pozidriv screwdriver PZ.0; PZ.1; PZ.2; PZ.3  
 Screwdriver probe voltage tester Testing range: 110~250V AC

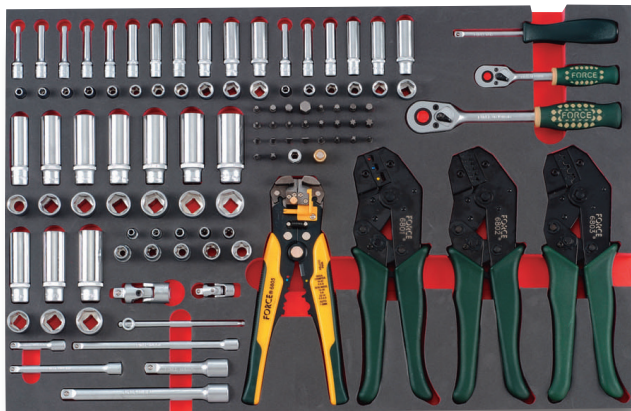

### 2 NO.31071

#### 107pc 3/8" & 1/4" DR. Socket set

6pt. Flank socket  
 1/4": 4; 4.5; 5; 5.5; 6; 7; 8; 9; 10; 11; 12 mm  
 1/4": 3/16"; 1/4"; 9/32"; 11/32"; 3/8"; 1/2"  
 3/8": 13; 14; 15; 16; 17; 18; 19 mm  
 3/8": 9/16"; 5/8"; 11/16"  
 1/4" deep: 4; 4.5; 5; 5.5; 6; 7; 8; 9; 10; 11; 12 mm  
 1/4" deep: 3/16"; 1/4"; 9/32"; 11/32" 3/8"; 1/2"  
 3/8" deep: 13; 14; 15; 16; 17; 18; 19 mm  
 3/8" deep: 9/16"; 5/8"; 11/16"  
 Star socket 1/4": E4; E5; E6; E7; E8  
 3/8": E10; E11; E12; E14; E16  
 Hex bit 3; 4; 5; 6 mm  
 1/8"; 3/16"; 1/4"; 3/8"  
 Phillips bit PH.1; PH.2; PH.3  
 Pozidriv bit PZ.1; PZ.2; PZ.3  
 Slotted bit 3; 4; 5.5; 6.5 mm  
 Star bit T8; T10; T15; T20; T25; T27; T30; T40  
 Ratchet handle 1/4"; 3/8"  
 Universal joint 1/4"; 3/8"  
 1/4"DR. Sliding T handle  
 1/4"DR. Spinner  
 1/4"DR. Magnetic socket pick-up  
 Extension 1/4": 2"; 4"; 6"  
 3/8": 3"; 6"  
 Bit holder 1/4"(F)x1/4"(F)  
 Terminal pliers red, green, yellow  
 Terminal pliers 0.5; 0.75; 1.0; 1.5; 2.5; 4  
 Terminal pliers 0.5-1; 1.1-2.5; 4-6  
 Heavy duty stripper pliers

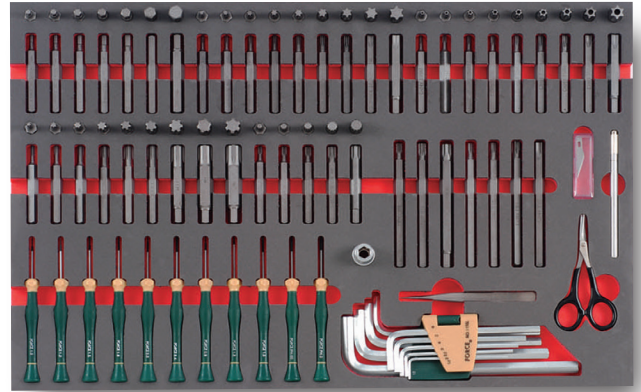

### 3 NO.41111

#### 11pc 10mm Bit & L key set

Hex bit (30 mmL) 4; 5; 6; 7; 8; 10; 12 mm  
 Hex bit (75 mmL) 4; 5; 6; 7; 8; 10; 12 mm  
 Star bit (30 mmL) T20; T25; T27; T30; T40; T45; T50; T55; T60  
 Star bit (75 mmL) T20; T25; T27; T30; T40; T45; T50; T55; T60  
 Star bit (120 mmL) T40; T45; T50; T55  
 Star tamperproof bit (30 mmL) T-20H; T-25H; T-27H; T-30H;  
 T-40H; T-45H; T-50H; T-55H; T-60H  
 Star tamperproof bit (75 mmL) T-20H; T-25H; T-27H; T-30H;  
 T-40H; T-45H; T-50H; T-55H; T-60H  
 Spline bit (30 mmL) M5; M6; M8; M10; M12  
 Spline bit (75 mmL) M5; M6; M8; M10; M12  
 Spline bit (120 mmL) M8; M10; M12  
 Ribe bit (30 mmL) M4; M5; M6; M8; M9; M10; M12; M13; M14  
 Ribe bit (75 mmL) M4; M5; M6; M8; M9; M10; M12; M13; M14  
 Bit holder 1/2"(F)x10mm(F)  
 Phillips jeweler screwdriver PH.000; PH.00  
 Slotted jeweler screwdriver 1.0; 1.2; 1.5; 1.8; 2.0; 2.4 mm  
 Hex jeweler screwdriver 0.9; 1.3; 1.5 mm  
 Tweezer  
 Scissor  
 Scalpel (with 6 blades)  
 Hex long key set 1.5; 2; 2.5; 3; 4; 5; 6; 7; 8; 10; 12 mm

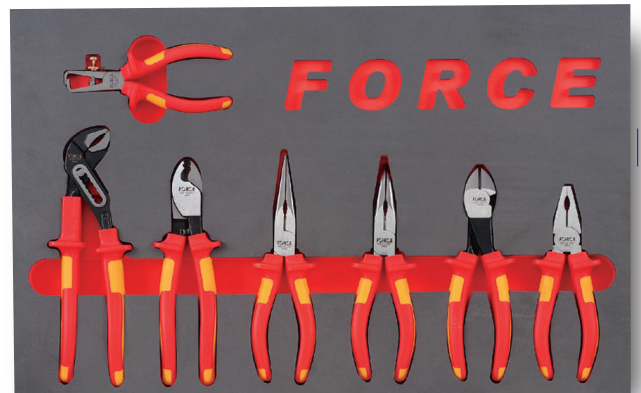

### 4 NO.50717

#### 7pc Insulated pliers set

Insulated combination pliers 7"  
 Insulated long nose pliers 8"  
 Insulated bent nose pliers 8"  
 Insulated water-pump pliers(Curved jaw) 10"  
 Insulated diagonal pliers 8"  
 Insulated wire stripper pliers 6"  
 Insulated cable cutter 8"





## 5 NO.5222

### 22pc Utility set

- Stainless steel vernier caliper
- Auto center punch
- Stainless steel straight rule 30cm
- Stainless steel protractor
- Screw pitch gauges 0.25-6 (Metric)
- Screw pitch gauges 4-62 (SAE)
- 26 sizes Feeler gauges (SAE & Metric)
- Steel scriber
- 5m measuring tape
- Straight shears
- Mini hacksaw frame 6"
- Saw blade
- Utility knife (incl. 3pc spare blades)
- Engineer hammer 300g
- Rubber hammer 400g (280mmL)
- Chisel 15mm (180mmL); 19mm (200mmL); 25mm (220mmL)
- Telescopic tubing cutter
- 3-IN-1 Tubing bender Size : 6; 8; 10 mm
- 3-IN-1 Tubing bender Size : 1/4"; 5/16"; 3/8"



## 7 NO.914G1V

### Universal radiator pressure tester kit

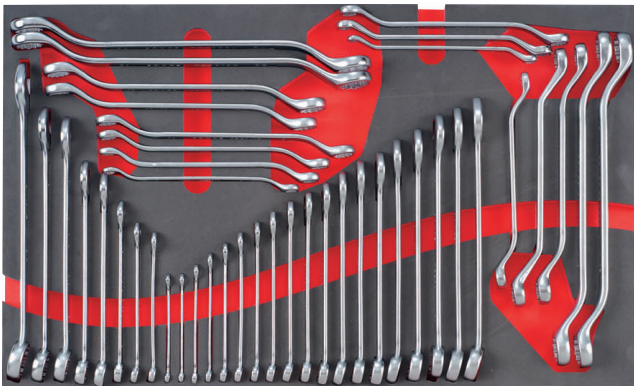

## 6 NO.5431

### 43pc Wrench set

- Combination wrench
- 6; 7; 8; 9; 10; 11; 12; 13; 14; 15; 16; 17; 18; 19; 20; 21; 22; 23 mm
- 1/4"; 3/8"; 7/16"; 1/2"; 5/8"; 11/16"; 13/16"; 7/8"; 1"
- 45 degree offset ring wrench
- 8x9; 10x11; 12x13; 14x15; 16x17; 18x19; 21x23; 22x24
- 1/4"x5/16"; 3/8"x7/16"; 7/16"x1/2"; 1/2"x9/16"; 5/8"x11/16"; 11/16"x3/4"; 13/16"x7/8"; 7/8"x15/16"



## 8 NO.9191

### 19pc Cup & swivel Oil filter wrench set

- Swivel handle oil filter wrench 2-3/8" to 2-7/8" (60mm - 73mm)
- Swivel handle oil filter wrench 2-7/8" to 3-3/8" (73mm - 85mm)
- Swivel handle oil filter wrench 3-3/8" to 3-3/4" (85mm - 95mm)
- Swivel handle oil filter wrench 3-3/4" to 4-3/8" (95mm - 111mm)
- 15pc Cup type oil filter wrench set

## 509pc tool set (mm) for trolley 10318 series!

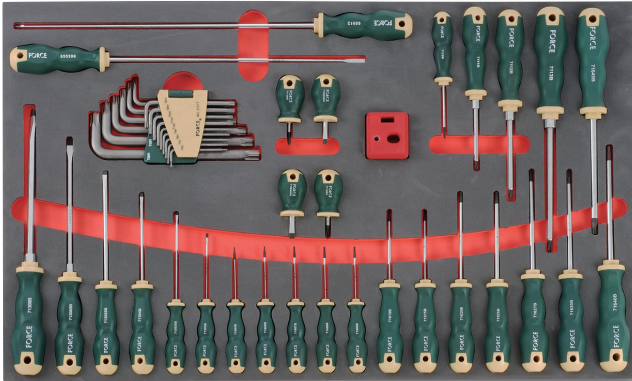

### 1 NO.2452

#### 45pc Screwdriver and key set

- ⊕ Short PH.1; PH.2
- ⊕ PH.0; PH.1; PH.2; PH.3
- ⊕ Long PH.2
- Short 5.5mm; 6.5mm
- 3; 3.5; 4; 5.5; 6.5; 8 mm
- Long 6mm
- ⊕ T5; T6; T7; T8; T9; T10; T15; T20; T25; T27; T30; T40; T45
- ⊕ T-6H; T-7H; T-8H; T-9H; T-10H; T-15H; T-20H; T-25H; T-27H; T-30H; T-40H; T-45H; T-50H; T-55H; T-60H

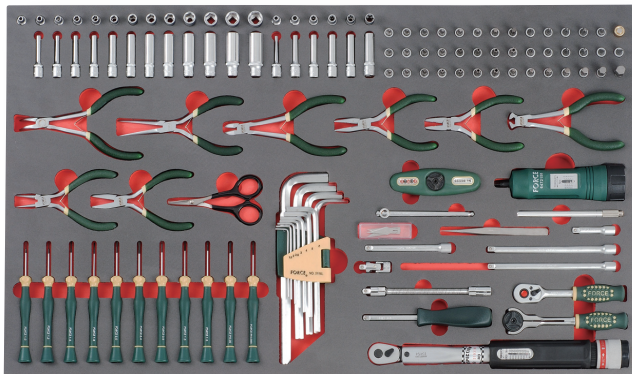

### 2 NO.21251

#### 125pc Socket and pliers set

- |  |  |
|--|--|
| <ul style="list-style-type: none"> <li>socket</li> <li>● 1/4", 3.2; 4; 4.5; 5; 5.5; 6; 7; 8; 9; 10; 11; 12; 13 mm</li> <li>● 1/4", Deep 4; 4.5; 5; 5.5; 6; 7; 8; 9; 10; 11; 12; 13 mm</li> <li>⊕ 1/4", E4; E5; E6; E7; E8; E10</li> <li>⊕ 1/4", Deep E4; E5; E6; E7; E8; E10</li> <li>socket bit</li> <li>⊕ 1/4", PH.0; PH.1; PH.2; PH.3</li> <li>⊕ 1/4", PZ.0; PZ.1; PZ.2; PZ.3</li> <li>● 1/4", 4; 5.5; 6.5 mm</li> <li>○ 1/4", 3; 4; 5; 6; 7; 8; 10 mm</li> <li>○ 1/4", T8; T10; T15; T20; T25; T27; T30; T40</li> <li>⊕ 1/4", T-8H; T-10H; T-15H; T-20H; T-25H; T-27H; T-30H; T-40H</li> <li>○ 1/4", TS10; TS15; TS20; TS25; TS27; TS30; TS40</li> <li>Hex long key set</li> <li>1.5; 2; 2.5; 3; 4; 5; 6; 7; 8; 10; 12 mm</li> <li>1/4" Ratchet handle 20 teeth</li> <li>1/4" 72 teeth flexible round ratchet handle</li> <li>1/4" T mini ratchet handle-48 teeth</li> <li>1/4" Sliding T handle (115mmL)</li> <li>1/4" Extension 2"; 4"; 6"; 10"</li> <li>1/4" Universal joint</li> </ul> | <ul style="list-style-type: none"> <li>Magnetic socket pick-up</li> <li>Flexible inhex extension</li> <li>Spinner</li> <li>1/4" Torque driver</li> <li>1/4" Lock torques wrench 6-30Nm</li> <li>Round nose pliers 5"</li> <li>Flat nose pliers 5"</li> <li>Combination pliers 5"</li> <li>Long nose pliers 5"</li> <li>Needle nose pliers 6"</li> <li>Bent nose pliers 6"</li> <li>Cutter pliers 6"</li> <li>Diagonal pliers 6"</li> <li>Phillips jeweler screwdriver</li> <li>PH.000; PH.00</li> <li>Slotted jeweler screwdriver</li> <li>1.0; 1.2; 1.5; 1.8; 2.0; 2.4 mm</li> <li>Hex jeweler screwdriver</li> <li>0.9; 1.3; 1.5 mm</li> <li>Tweezer</li> <li>Scissors</li> <li>Scalpel (with 6 blades)</li> </ul> |
|--|--|

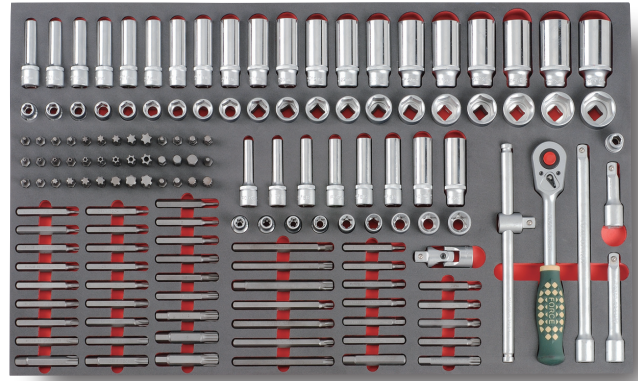

### 3 NO.41491

#### 149pc 1/2" DR. Combination set

- socket
- 1/2", 10; 11; 12; 13; 14; 15; 16; 17; 18; 19; 20; 21; 22; 23; 24; 26; 27; 28; 30; 32 mm
- 1/2", Deep 10; 11; 12; 13; 14; 15; 16; 17; 18; 19; 20; 21; 22; 23; 24; 26; 27; 28; 30; 32 mm
- ⊕ 1/2", E10; E11; E12; E14; E16; E18; E20; E22; E24
- ⊕ 1/2", Deep E10; E11; E12; E14; E16; E18; E20; E24
- bit
- 1/2", 4; 5; 6; 7; 8; 10; 12 mm
- 1/2", Long 4; 5; 6; 7; 8; 10; 12 mm
- ⊕ 1/2", T20; T25; T27; T30; T40; T45; T50; T55; T60
- ⊕ 1/2", Long T20; T25; T27; T30; T40; T45; T50; T55; T60
- ⊕ 1/2", Extra Long T40; T45; T50; T55
- ⊕ 1/2", T-20H; T-25H; T-27H; T-30H; T-40H; T-45H; T-50H; T-55H; T-60H
- ⊕ 1/2", T-20H; T-25H; T-27H; T-30H; T-40H; T-45H; T-50H; T-55H; T-60H
- 1/2", M5; M6; M8; M10; M12
- 1/2", Long M5; M6; M8; M10; M12
- 1/2", Extra Long M8; M10; M12
- 1/2", M4; M5; M6; M8; M9; M10; M12; M13; M14
- 1/2", Long M4; M5; M6; M8; M9; M10; M12; M13; M14

- Ratchet handle 36 teeth
- Universal joint
- Extension 3"; 5"; 10"
- Sliding T handle 10"(250mmL)
- Bit holder 1/2"(F)x10mm(F)

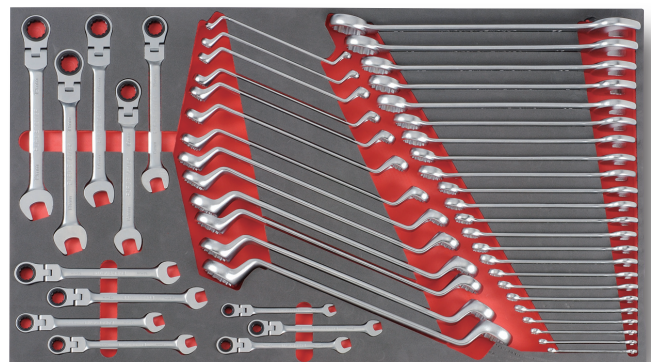

### 4 NO.5481

#### 48pc Spanner set

- Combination wrench
- 6; 7; 8; 9; 10; 11; 12; 13; 14; 15; 16; 17; 18; 19; 21; 22; 23; 24; 26; 27; 28; 30; 32 mm
- 75° Offset ring wrench
- 6x7; 8x9; 10x11; 12x13; 14x15; 16x17; 18x19; 21x23; 20x22; 23x26; 24x27; 25x28; 30x32 mm
- Flexible gear wrench
- 8; 9; 10; 11; 12; 13; 14; 15; 16; 17; 18; 19 mm



## 5 NO.5173

### 17pc Pliers set

- Snap ring pliers
- External straight tip 1.8mm (open)
- Internal straight tip 1.8mm (close)
- External 90° Bent tip 1.8mm (open)
- Internal 90° Bent tip 1.8mm (close)
- Bent long Nose pliers 8"
- Long Nose pliers 8"
- Combination pliers 8"
- Diagonal pliers 7"
- Slip joint pliers 215mmL
- Waterpump pliers 10"
- Cable cutter 250mmL
- Heavy duty stripper pliers
- Locking pliers 10"
- Adjustable locking pliers
- Adjustable gauged wrench (250mmL)
- 4-in-1 Electrical pliers
- Plastic cutting pliers 160mmL



## 7 NO.5521

### 52pc File and measurement tool set

- Flare nut wrench
- 8x10; 9x11; 11x13; 12x14; 14x17; 16x18; 17x19; 19x22; 24x27; 30x32 mm
- 8" Flat file
- 8" Half round file
- 8" Round file
- 8" Square file
- 8" Triangular file
- Impact driver
- 5/16" bit
- Phillips bit PH.2; PH.3 (36mmL)
- Slotted 9; 11 mm (36mmL)
- Hex 6; 8; 10 mm (36mmL)
- Star T25; T30; T40; T45; T50(35mmL)
- Bit adaptor 5/16"Hex-3/8"Sq.
- Impact bit holder 1/2"DR.x5/16"
- Stud extractor 6; 8; 10; 12 mm
- Nut splitter 5/16" - 1/2" (9-12mm); 1/2" - 5/8" (12-16mm); 5/8" - 7/8" (16-22mm)
- Screw extractor
- 7/64"; 9/64"; 5/32"; 1/4"; 19/64"
- Stainless steel vernier caliper
- Auto center punch
- Stainless steel straight rule 30cm
- Stainless steel protractor
- Screw pitch gauges 0.25-6(MM)
- Screw pitch gauges 4-62(SAE)
- Steel scriber
- 26 sizes Feeler gauges (SAE & MM)
- Limber magnetic LED light
- 3-in-1 Magnetic flexible pickup tool



## 6 NO.5242

### 24pc Chisel & hammer set

- chisel 10; 12; 15; 19; 22; 25 mm
- cape chisel
- pin punch 2; 3; 4; 5; 6; 8 mm
- taper punch 4; 5; 6; mm
- center punch 4 mm
- Rubber Hammer 280mmL
- Engineer hammer 300gw
- Utility knife (incl. 3pc spare blades)
- Mini hacksaw
- Technician's scissors 145mmL
- Straight shears
- 5M measuring tape



## 8 NO.4491

### 49pc Impact socket set

- socket
- 1/2", 10; 11; 12; 13; 14; 15; 16; 17; 18; 19; 20; 21; 22; 23; 24; 26; 27; 28; 30; 32 mm
- 1/2", Deep 10; 11; 12; 13; 14; 15; 16; 17; 18; 19; 20; 21; 22; 23; 24; 26; 27; 28; 30; 32 mm
- 1/2", Wheel nut opt. flank impact socket (85mmL) 17; 19; 21 mm
- Impact universal joint (pin type)
- Impact extension 5" (pin type)
- Wheel balancing weight tool
- Lock torques wrench 40-200Nm (window display)
- Mini composite impact wrench
- Assembly wheel nut wrench 17; 19; 13/16"; 1/2"DR. (300mmL)

## 407pc tool set (sae&mm) for trolley 10318 series!

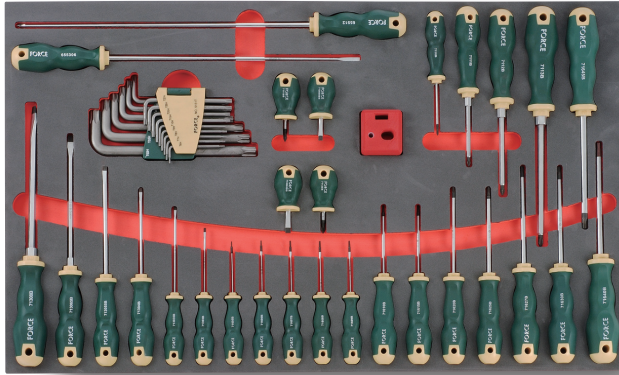

### 1 NO.2452

#### 45pc Screwdriver and key set

- ⊕ Short PH.1; PH.2
- ⊕ PH.0; PH.1; PH.2; PH.3
- ⊕ Long PH.2
- Short 5.5mm; 6.5mm
- 3; 3.5; 4; 5.5; 6.5; 8 mm
- Long 6mm
- ⊕ T5; T6; T7; T8; T9; T10; T15; T20; T25; T27; T30; T40; T45
- ⊗ T-6H; T-7H; T-8H; T-9H; T-10H; T-15H; T-20H; T-25H; T-27H; T-30H; T-40H; T-45H; T-50H; T-55H; T-60H

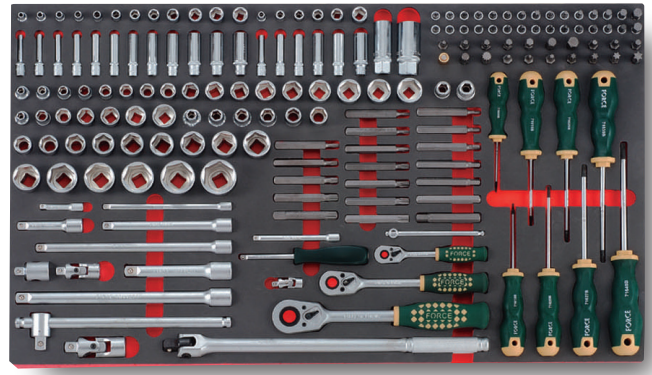

### 3 NO.41811

#### 181pc Socket & star screwdriver set

- socket
- 1/4", 4; 4.5; 5; 5.5; 6; 7; 8; 9; 10; 11; 12; 13 mm
- 3/16"; 1/4"; 9/32"; 11/32"; 3/8"; 1/2"
- Deep 4; 4.5; 5; 5.5; 6; 7; 8; 9; 10; 11; 12; 13 mm
- Deep 3/16"; 1/4"; 9/32"; 11/32"; 3/8"; 1/2"
- 3/8", 6; 7; 8; 9; 10; 11; 12; 13; 14; 15; 16; 17; 18; 19; 20; 21; 22 mm
- 1/4"; 3/8"; 1/2"; 9/16"; 5/8"; 11/16"; 13/16"
- 1/2", 8; 10; 11; 12; 13; 14; 15; 16; 17; 18; 19; 20; 21; 22; 23; 24; 26; 27; 28; 30; 32 mm
- Socket bit
- 32mm Hex 3; 4; 5; 6; 7; 8; 10 mm
- Hex 1/8"; 3/16"; 7/32"; 1/4"; 3/8"
- Phillips PH.1; PH.2; PH.3
- Pozidriv PZ.1; PZ.2; PZ.3
- Slotted 3; 4; 5.5; 6.5 mm
- Star T8; T10; T15; T20; T25; T27; T30; T40
- 10mm Hex 4; 5; 6; 7; 8; 10; 12; (30mmL)
- Hex 4; 5; 6; 7; 8; 10; 12; (75mmL)
- Star T20; T25; T30; T40; T45; T50; T55; (30mmL)
- Star T20; T25; T30; T40; T45; T50; T55; (75mmL)
- Spline M5; M6; M8; M10; M12; (30mmL)
- Spline M5; M6; M8; M10; M12; (75mmL)
- Ratchet handle 1/4" & 3/8" & 1/2"
- Universal joint 1/4" & 3/8" & 1/2"
- Sliding T handle 1/4" & 1/2"
- Extension 1/4", 2" & 4" & 6"
- 3/8", 3" & 6" & 9"
- 1/2", 5" & 10"
- Spark plug socket 16mm; 20.6mm
- Spinner 6"
- Magnetic socket pick-up
- Adaptor for Extension 1/2"(F)\*3/8"(M)
- Swivel handle 15"
- Bit holder 1/2"DR.x10mm & 3/8"DR.x10mm
- Anti-Slip Star Screw drivers
- T8; T10; T15; T20; T25; T27; T30; T40



### 2 NO.5581

#### 58pc Combination and gear wrench set

- Combination wrench
- 6; 7; 8; 9; 10; 11; 12; 13; 14; 15; 16; 17; 18; 19; 21; 22; 23; 24; 26; 27; 28;
- 30; 32 mm
- 1/4"; 3/8"; 7/16"; 1/2"; 9/16"; 5/8"; 11/16"; 13/16"; 7/8"; 15/16"; 1"; 1-1/8"; 1-1/4"
- Reversible gear wrench
- 8; 9; 10; 11; 12; 13; 14; 15; 16; 17; 18; 19 mm
- 3/8"; 7/16"; 1/2"; 9/16"; 5/8"; 11/16"



## 4 NO.5173

### 17pc Pliers set

- Snap ring pliers
  - External straight tip 1.8mm (open)
  - Internal straight tip 1.8mm (close)
  - External 90° Bent tip 1.8mm (open)
  - Internal 90° Bent tip 1.8mm (close)
- Bent long Nose pliers 8"
- Long Nose pliers 8"
- Combination pliers 8"
- Diagonal pliers 7"
- Slip joint pliers 215mmL
- Waterpump pliers 10"
- Cable cutter 250mmL
- Heavy duty stripper pliers
- Locking pliers 10"
- Adjustable locking pliers
- Adjustable gauged wrench (250mmL)
- 4-in-1 Electrical pliers
- Plastic cutting pliers 160mmL



## 6 NO.5521

### 52pc File and measurement tool set

- Flare nut wrench
  - 8x10; 9x11; 11x13; 12x14; 14x17; 16x18; 17x19; 19x22; 24x27; 30x32 mm
- 8" Flat file
- 8" Half round file
- 8" Round file
- 8" Square file
- 8" Triangular file
- Impact driver
- 5/16" bit
  - Phillips bit PH.2; PH.3 (36mmL)
  - Slotted 9; 11 mm (36mmL)
  - Hex 6; 8; 10 mm (36mmL)
  - Star T25; T30; T40; T45; T50(35mmL)
- Bit adaptor 5/16"Hex-3/8"Sq.
- Impact bit holder 1/2"DR.x5/16"
- Stud extractor 6; 8; 10; 12 mm
- Nut splitter 5/16" - 1/2" (9-12mm); 1/2" - 5/8" (12-16mm); 5/8" - 7/8" (16-22mm)
- Screw extractor
  - 7/64"; 9/64"; 5/32"; 1/4"; 19/64"
- Stainless steel vernier caliper
- Auto center punch
- Stainless steel straight rule 30cm
- Stainless steel protractor
- Screw pitch gauges 0.25-6(MM)
- Screw pitch gauges 4-62(SAE)
- Steel scribe
- 26 sizes Feeler gauges (SAE & MM)
- Limber magnetic LED light
- 3-in-1 Magnetic flexible pickup tool



## 5 NO.5242

### 24pc Chisel & hammer set

- chisel 10; 12; 15; 19; 22; 25 mm
- cape chisel
- pin punch 2; 3; 4; 5; 6; 8 mm
- taper punch 4; 5; 6; mm
- center punch 4 mm
- Rubber Hammer 280mmL
- Engineer hammer 300gw
- Utility knife (incl. 3pc spare blades)
- Mini hacksaw
- Technician's scissors 145mmL
- Straight shears
- 5M measuring tape

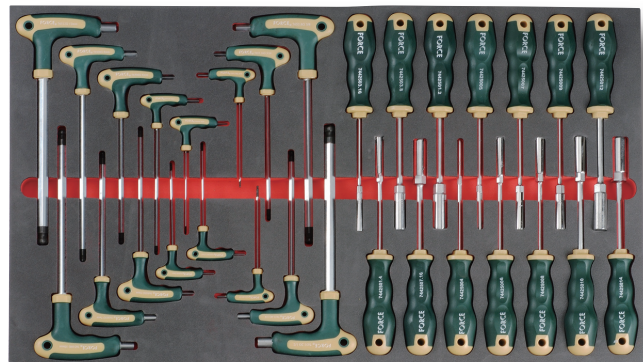

## 7 NO.5301

### 30pc Hex nut driver and grip key set (S&M)

- Hex nut driver
  - 4; 5; 6; 7; 8; 9; 10; 12; 14 mm
  - 3/16"; 1/4"; 3/8"; 7/16"; 1/2"
- Hex and Hex-ball grip key
  - 2; 2.5; 3; 4; 5; 6; 7; 8; 10; 12 mm
  - 3/32"; 1/8"; 3/16"; 1/4"; 3/8"; 1/2"

## Optional tool sets for trolley 10318 series!

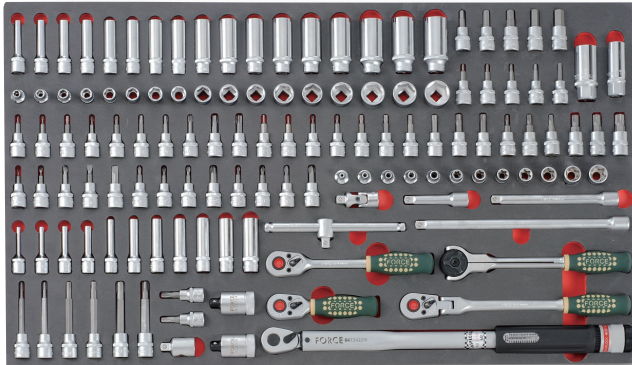

### 1 NO.31292

#### 129pc 3/8"DR. Combination set (MM)

- socket
  - 3/8", 6; 7; 8; 9; 10; 11; 12; 13; 14; 15; 16; 17; 18; 19; 20; 21; 22 mm
  - 3/8", Deep 6; 7; 8; 9; 10; 11; 12; 13; 14; 15; 16; 17; 18; 19; 20; 21; 22 mm
  - ⊕ 3/8", E4; E5; E6; E7; E8; E10; E11; E12; E14; E16; E18; E20
  - ⊕ 3/8", Deep E4; E5; E6; E7; E8; E10; E11; E12; E14; E16; E18
  - 3/8", 6; 7; 8; 9; 10; 11; 12; 13; 14; 15; 16; 17; 18; 19; 20; 21; 22 mm
- socket bit
  - 3/8", 3; 4; 5; 5.5; 6; 7; 8; 9; 10; 12 mm
  - ⊕ 3/8", T8, T10, T15, T20, T25, T27, T30, T40, T45, T50
  - ⊕ 3/8", T-8H; T-10H; T-15H; T-20H; T-25H; T-27H; T-30H; T-40H; T-45H, T-50H
  - 3/8", M5; M6; M8; M9; M10; M12
  - ⊕ 3/8", TS45; TS50
  - ⊕ 3/8", PH.1; PH.2; PH.3; PH.4
  - ⊕ 3/8", PZ.1; PZ.2; PZ.3; PZ.4
  - 3/8", 4; 5.5; 6; 7; 8 mm
  - 3/8", M5; M6; M7; M8; M9; M10
- 30 teeth ratchet handle
- 30 teeth stubby ratchet handle
- Flexible Pear ratchet 30 teeth
- Flexible ratchet handle-72 teeth
- Lock torques wrench 70-100Nm (window display)
- Extension 3"; 6"; 10"
- Universal joint
- Sliding T bar
- Adaptor for extension 1/2"(F)x3/8"(M)
- Spark plug socket 16; 20,6 mm
- Torque adapter 18Nm; 24Nm

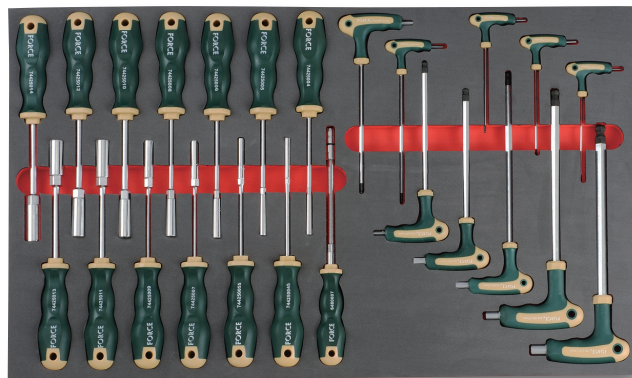

### 2 NO.5241

#### 24pc Hex nut driver and grip key set

- Hex nut driver
  - 4; 4.5; 5; 5.5; 6; 7; 8; 9; 10; 11; 12; 13; 14 mm
- Hex and Hex-ball grip key
  - ⊕ 2; 2.5; 3; 4; 5; 6; 7; 8; 10; 12 mm



### 3 NO.5391

#### 39pc socket bit and spanner set

- Double open end wrench
  - 6x7; 8x9; 10x11; 12x13; 14x15; 16x17; 18x19; 20x22; 21x23; 23x26; 24x27; 25x28; 30x32
- Hinged socket wrench
  - 6x7; 8x9; 10x11; 12x13; 14x15; 16x17; 18x19; 20x22; 21x23; 24x27; 30x32
- Socket bit
  - 1/2", 140mmL 6; 8; 10; 12; 14 mm
  - ⊕ 1/2", 200mmL T30; T40; T45; T50
  - ⊕ 1/2", 55mmL T70
  - ⊕ 1/2", 70mmL T80
  - 1/2", 55mmL M16
  - 1/2", 140mmL M8; M10; M12; M14

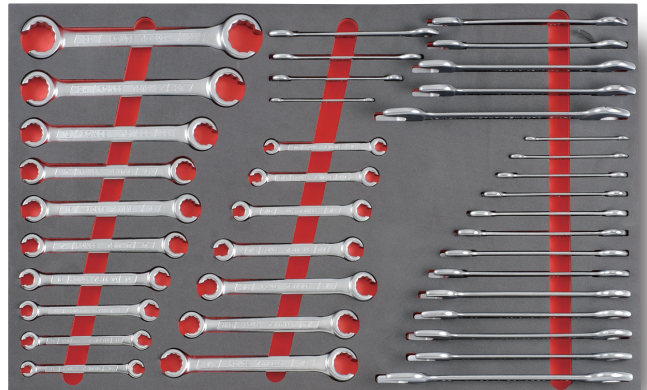

### 4 NO.5392

#### 39pc Spanner set (S&M)

- Double open end wrench
  - 6x7; 8x9; 10x11; 12x13; 14x15; 16x17; 18x19; 20x22; 21x23; 23x26; 24x27; 25x28; 30x32 mm
  - 1/4"x5/16"; 3/8"x7/16"; 1/2"x9/16"; 5/8"x11/16"; 3/4"x25/32"; 13/16"x7/8"; 15/16"x1"; 15/16"x1-1/16"; 1-1/8"x1-1/4"
- Flare nut wrench
  - 8x10; 9x11; 11x13; 12x14; 14x17; 16x18; 17x19; 19x22; 24x27; 30x32 mm
  - 5/16"x3/8"; 3/8"x7/16"; 7/16"x1/2"; 1/2"x9/16"; 5/8"x3/4"; 11/16"x3/4"; 3/4"x7/8"

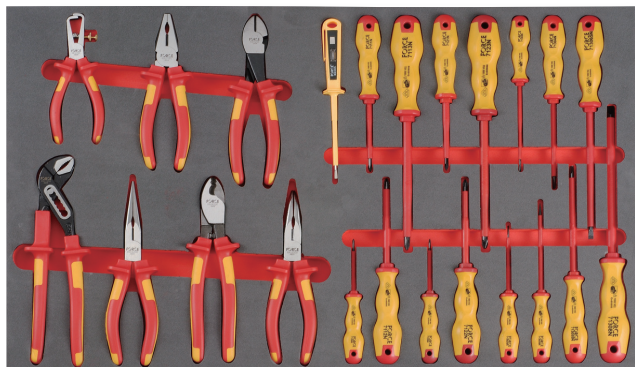

## 5 NO.2233

### 23pc Insulated screwdriver and pliers set

- 2.4; 3; 3.5; 4; 5.5; 6.5; 8 mm
- ⊕ PZ.0; PZ.1; PZ.2; PZ.3
- ⊕ PH.0; PH.1; PH.2; PH.3
- ⊕ Screwdriver probe voltage tester: 110~250V AC
- ⊕ Screwdriver probe voltage tester Testing range: 110~250V AC
- ⊕ Insulated combination pliers 7"
- ⊕ Insulated long nose pliers 8"
- ⊕ Insulated bent nose pliers 8"
- ⊕ Insulated water pump pliers(Curved jaw) 10"
- ⊕ Insulated diagonal pliers 8"
- ⊕ Insulated wire stripper pliers 6"
- ⊕ Insulated cable cutter 8"

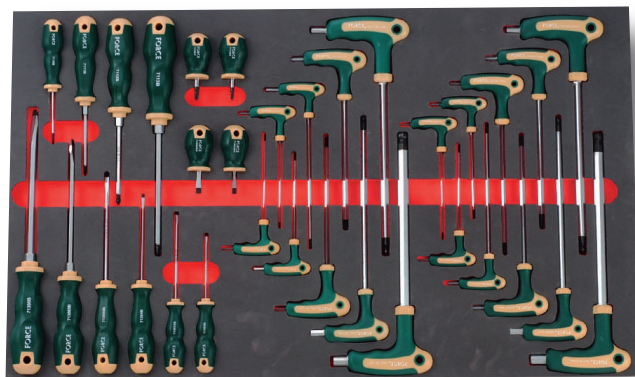

## 6 NO.2333

### 33pc Screwdriver and hex-ball-point grip key

- ⊕ Slotted screwdrivers 3mm ; 3.5mm ; 4mm ; 5.5mm ; 6.5mm ; 8mm
- ⊕ Slotted stubby screwdrivers 5.5mm ; 6.5mm
- ⊕ Phillips screwdrivers PH.0 ; PH.1 ; PH.2 ; PH.3
- ⊕ Phillips stubby screwdrivers PH.1 ; PH.2
- ⊕ Hex & hex-ball-point grip key
- ⊕ 2; 2.5; 3; 4; 5; 6; 7; 8; 10; 12 mm
- ⊕ 5/64"; 3/32"; 1/8"; 5/32"; 3/16"; 1/4"; 5/16"; 3/8"; 1/2"



## 7 NO.51111

### 11pc Cordless impact wrench

- ⊕ 1/2"DR. Cordless impact wrench package
- ⊕ Cordless angle grinder package
- ⊕ Cordless drill package



## 8 NO.9171

### 17pc Universal valve adjustment & compressor tester set

- ⊕ 9pc Universal valve adjustment tools
- ⊕ Gas cylinder compression tester



## 9 NO.9391

### 39pc Cup & swivel Oil filter wrench set

- ⊕ 15pc Cup type oil filter wrench set
- ⊕ 6pt. Flank impact socket
- ⊕ 10; 11; 12; 13; 14; 15; 16; 17; 18; 19; 21; 22; 23; 24; 26; 27; 30; 32 mm
- ⊕ Ball-type impact extension (125mmL)
- ⊕ Wheel nut 6pt. Flank impact socket 17; 19; 21mm (85mmL)
- ⊕ Lock torque wrench - window display
- ⊕ 3/8"DR, 70-100Nm, 420mmL
- ⊕ 1/2"DR, 40-200Nm, 530mmL

■ **50230-95**







**50230-95**

**95pc Tool Box**

Part no.	1/10.8/11.8/1.3'	10.78kg
	Content:	
610B160	1-Long nose pliers 6.3"	
612B160	1-Diagonal pliers 6.3"	
611B160	1-Combination pliers 6.3"	
5102	10pc Hex key	
764 0127...10	1.27; 1.5; 2; 2.5; 3; 4; 5; 6; 8; 10 mm	
5055P4	1-Utility knife (incl. 3 pc blades)	
613200	1-Water pump pliers 8"	
614175	1-Locking pliers 7"	
649200C	1-BV series adjustable wrench 8"	
5096P803	1-3m measuring tape	
755 08...24	14-Combination wrench 8, 9, 10, 11, 12, 13, 14, 15, 16, 17, 18, 19, 22, 24	
6982	1-Technician's scissors	
7111N	1-Phillips insulated screwdriver PH.1	
71304N	1-Slotted insulated screwdriver 4	
88407	1-Adjustable non-contact wire tracer 12-600V AC	

Part no.	1/10.8/11.8/1.3'	10.78kg
	Content:	
711 1M.....2M	2-Phillips hammer screwdriver PH.1, 2	
71308M	1-Slotted hammer screwdriver 8	
7130 55M...65M	2-Slotted hammer screwdriver 5.5, 6.5	
7130 3B...4B	2-Slotted screwdriver 3, 4	
7110B	1-Phillips screwdriver PH.0	
617L	1-3-in-1 magnetic flexible pickup tool with light & mirror	
2421F	42pc 1/4" 6pt. Flank socket set	
616A400	1-Soft face hammer 400gw	
616F032	1-Reviting hammer 32mm	
6044190	1-Pin punch 190mmL 4	
6074185	1-Center punch 185mmL 4	
60212150	1-Chisel 150mmL 12	
603150	1-Cape chisel 150mmL	
6063185	1-Taper punch 185mmL 3	
66301	1-Super heavy duty hacksaw	

■ **50234**



L45 x W33 x H15 cm  
1pc / 12.9 / 13.9 / 1.5'

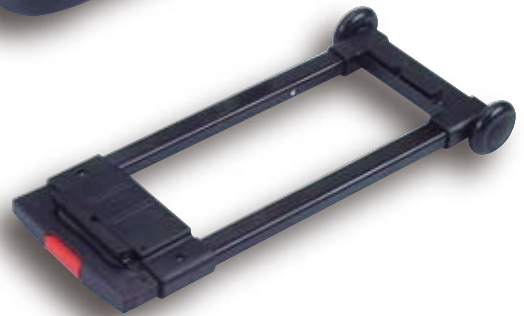

Locking by key for sure security



Sturdy corners to stand up bumps.



Small but strong hook to fix case to trolley.





## 50234-30

**Black suitcase with 29pcs of tools**

Part no.	1/16.5/17.8/1'	16.5kg
Content:		
6904160	1-Insulated long nose pliers 6"	
6903180	1-Insulated combination pliers 7"	
6905160	1-Insulated diagonal cutting pliers 6"	
6907250	1-Insulated water pump pliers (Curved jaw)10"	
6912160	1-Insulated wire stripper pliers 6"	
649250A	1-Adjustable gauged wrench 10"	
713 03N...065N	4-Insulated slotted screwdriver 3mm(100mmL); 4mm(100mmL); 5.5mm(125mmL); 6.5mm(150mmL)	
711 1N...2N	2-Insulated phillips screwdriver PH.1(80mmL); PH.2(100mmL)	
6982	1-Technician's scissors 145mmL	
5055P4	1-Utility knife (incl. 2pc blades)	
88404	1-Screwdriver probe voltage tester Testing range: 110~250V AC	
5096P803	1-Measuring tape 3M	
21111	11pc bit combination set	
12125 0...3	Phillips PH.0; PH.1; PH.2; PH.3	
12250 0...3	Pozidriv PZ.0; PZ.1; PZ.2; PZ.3	
12325 055...065	Slotted 5.5; 6.5 mm	
81260Q	Magnetic quick-release bit holder	
827A31	1-Cordless drill (Incl. charger)	
66303	1-Hacksaw 315mmL	



■ **50234-107**



With 107pcs of tools in the layers as follows :



**50234-107**

**Black suitcase with 107pcs of tools**



Part no.	1/12.9/13.9/1'	12.9Kg
<b>Content:</b>		
711 1N...2N	2-Insulated phillips screwdriver PH.1; PH.2	
713 03N...065N	4-Insulated slotted screwdriver 3; 4; 5.5; 6.5 mm	
7112BS	1-Stubby phillips screwdriver PH.1	
713065BS	1-Stubby slotted screwdriver 6.5 mm	
711 1B...3B	3-Phillips screwdriver PH.1; PH.2; PH.3	
6907250	1-Insulated water pump pliers (Curved jaw)	
649250A	1-Adjustable gauged wrench (250mmL)	
6904160	1-Insulated long nose pliers 6"	
6903180	1-Insulated combination pliers 7"	
6905160	1-Insulated diagonal cutting pliers 6"	
6912160	1-Insulated wire stripper pliers 6"	
2421BF	14-1/4" DR. 6pt. Flank socket	
525 032...14	3.2; 4; 4.5; 5; 5.5; 6; 7; 8; 9; 10; 11; 12; 13; 14mm	
	20-1/4" bit 25mmL	
12325 04...065	Slotted 4; 5.5; 6.5 mm	
12425 03...08	Hex 3; 4; 5; 6; 8 mm	
12125 1...3	Phillips PH.1; PH.2; PH.3	
12225 1...3	Pozidriv PZ.1; PZ.2; PZ.3	
12625 10...40	Star T10; T15; T20; T25; T30; T40	
802202F	1-Flexible bit ratchet handle for 1/4" inhex	
8042 050...150	2-Extension 2" & 6"	
80521	1-Universal joint	
8092225	1-Bit adaptor 1/4"Hex-1/4"Sq.	
8143	1-Spinner	
80632	1-Adaptor for extension 3/8"(F)x1/4"(M)	
81225	1-Magnetic socket pick up	
545 10...24	10-1/2"DR. 6pt. Flank socket	
	10; 12; 13; 14; 15; 17; 19; 21; 22; 24 mm	
616300	1-Engineer hammer 300gw	
616400	1-Rubber hammer 400gw	
68604	1-Dynamo LED torch	
66302	1-Mini hacksaw 6"	
5055P3	2pc Saw blade	
80242	1-24 teeth Ratchet handle	
2125P1	1-Induction circuit tester	
5096P8	1-5m measuring tape	
5096P2	1-Auto center punch	
5115	11-Combination wrench	
755 08...22	8; 10; 11; 12; 13; 14; 15; 17; 19; 21; 22 mm	
5055P4	1-Utility knife (incl. 2pc blades)	
5054	1-Chisel 12mm (150mmL)	
60212150	1-Cape chisel (150mmL)	
603150	1-Pin punch 4mm (190mmL)	
6044190	1-Taper punch 3mm (185mmL)	
6063185	1-Center punch 4mm (185mmL)	
6074185		
614250	1-Locking pliers 10"	
5102LB	10-Hex ball point long key	
765 0127L...10L	1.27; 1.5; 2; 2.5; 3; 4; 5; 6; 8; 10 mm	

**50233**



L53.5 x W25.8 x H16.5 cm  
1pc / 5.9kg / 6.9kg / 1.5'



**50235**

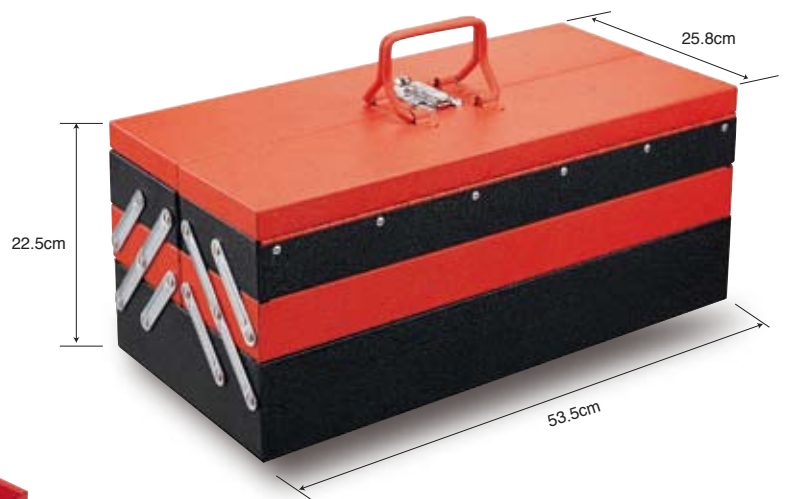

L53.5 x W25.8 x H22.5 cm  
1pc / 8.2kg / 9.6kg / 2'



**50233-42 / 50235-42**



C5211



C20913



C51220

**50233-48 / 50235-48**



C5166



C2206



C51221

**50235-89**



C2193



C50412



C50630



C50631



C5541

**50235-101**



C5153



C5142



C21114



C4482



C5136

**50235-124**



C5203



C5142



C21114



C3661



C5136





## C20913

### 9pc Insulated screwdriver set

Part no.	10/8.1/9.1/0.68'	810g
711 1N...2N	2-Insulated Phillips screwdriver PH.1(80mmL); PH.2(100mmL)	
713 024N...065N	4-Insulated slotted screwdriver 2.4(75mmL); 4(100mmL); 5.5(125mmL); 6.5(150mmL)	
88403	1-Screwdriver probe voltage tester Testing range: 80~250V AC	
5096P8	1-Measuring tape 5m	
68601	1-LED white light, clip-type (360°rotation)	



## C21114

### 11pc screwdriver set

Part no.	10/7.5/8.5/0.68'	750g
711 0B...2B	3-Phillips screwdriver PH.0x60mmL; PH.1x80mmL; PH.2x100mmL	
711 1BS...2BS	2-Stubby Phillips screwdriver PH.1x25mmL; PH.2x25mmL	
713 03B...065B	4-Slotted screwdriver 3mmx75mmL; 4mmx100mmL; 5.5mmx125mmL; 6.5mmx150mmL	
713 055BS...065BS	2-Stubby slotted screwdriver 5.5mmx25mmL; 6.5mmx25mmL	

## C2193

### 19pc Insulated screwdriver set

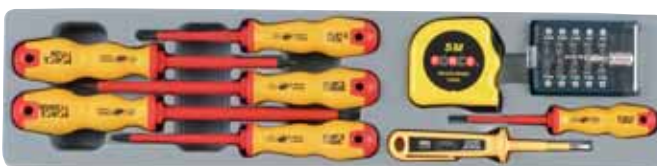

Part no.	10/9.1/10.1/0.68'	912g
711 1N...2N	2-Insulated Phillips screwdriver PH.1(80mmL); PH.2(100mmL)	
713 024N...065N	4-Insulated slotted screwdriver 2.4(75mmL); 4(100mmL); 5.5(125mmL); 6.5(150mmL)	
88403	1-Screwdriver probe voltage tester Testing range: 80~250V AC	
5096P8	1-Measuring tape 5m	
21112	11pc 1/4" bit	
12125 1...3	Phillips bit PH.1; PH.2x2; PH.3 (25mmL)	
12225 1...3	Pozidriv bit PZ.1; PZ.2x2; PZ.3 (25mmL)	
12325 055...065	Slotted bit 5.5; 6.5mm (25mmL)	
81260Q	Magnetic quick-release holder	



## C2206

### 20pc Screwdriver and L key set

Part no.	10/11.3/12.3/0.68'	1129g
711 1B...2B	2-Phillips screwdriver PH.1x80mmL; Ph.2x100mmL	
7112BS	1-Stubby Phillips screwdriver PH.2x25mmL	
713 03B...065B	4-Slotted screwdriver 3mmx75mmL; 4mmx100mmL; 5.5mmx125mmL; 6.5mmx150mmL	
713065BS	1-Stubby slotted screwdriver 6.5mmx25mmL	
5102	10pc Hex key	
764 0127...10	1.27; 1.5; 2; 2.5; 3; 4; 5; 6; 8; 10 mm	
5096P8	1-Measuring tape 5M	
68601	1-LED white light, clip-type (360°rotation)	

## C3661

### 66pc Combination set (S&M)



Part no.	6/17.0/18.0/0.72'	2830g
	<b>Content: 1/4" &amp; 3/8" DR.</b>	
525 04...12	1/4" part 11-6pt. Flank socket (MM) 4; 4.5; 5; 5.5; 6; 7; 8; 9; 10; 11; 12 mm	
525 3.16...1.2	9-6pt. Flank socket (SAE) 3/16"; 7/32"; 1/4"; 9/32"; 5/16"; 11/32"; 3/8"; 7/16"; 1/2"	
80521	1-Universal joint	
81022	1-Bit holder	
802223	1-Magnetic socket pick-up	
8032115	1-72 teeth flexible round ratchet	
8143	1-Sliding T handle	
8042 050...150	1-Spinner 2-Extension 50mmL-2" & 150mmL-6"	
21111	11pc bit combination set	
535 10...22	3/8" part 12-6pt. Flank socket (MM) 10; 11; 12; 13; 14; 15; 16; 17; 18; 19; 21; 22 mm	
535 3.8...7.8	7-6pt. Flank socket (SAE) 3/8"; 7/16"; 1/2"; 9/16"; 5/8"; 11/16"; 7/8"	
80531	1-Universal joint	
80232	1-24 teeth Ratchet	
8073 16...20.6	2-Spark plug socket 16 & 20.6 mm	
80643	1-Adaptor 1/2"(F)x3/8"(M)	
8043 075...250	3-Extension 75mmL-3"; 150mmL-6"; 250mmL-10"	



## C4482

### 48pc 1/4" & 1/2" socket combination set

Part no.	10/8.1/9.1/0.68'	810g
25 04...12	<b>Content: 1/4" &amp; 3/8" DR.</b> 1/4" parts 11-6pt. Flank Socket 4; 4.5; 5; 5.5; 6; 7;	
8042 050...150	8; 9; 10; 11; 12 mm	
80521	2-Extension 2" & 6"	
81225	1-Universal joint	
81022	1-Magnetic socket pick-up	
802223	1-Bit holder 1/4"(F)x1/4"(F)	
8032115	1-72th flexible round ratchet	
8143	1-Sliding T handle	
21111	1-Spinner	
12125 0...3	11pc bit combination set	
12250 0...3	Phillips PH.0; PH.1; PH.2; PH.3	
12325 055...065	Pozidriv PZ.0; PZ.1; PZ.2; PZ.3	
81260Q	Slotted 5.5; 6.5 mm Magnetic quick-release bit holder	
545 10...24	1/2" parts 13-6pt. Flank Socket 10; 11; 12; 13; 14; 15; 16;	
80634	17; 18; 19; 21; 22; 24 mm	
80541	1-Adaptor for extension	
80242	1-Universal joint	
8044 125...250	1-24th Ratchet handle 2-Extension 125-5"; 250-10"	



## C50412

### 4pc Insulated pliers set

Part no.	10/8.6/9.6/0.68'	855g
6903180	1-Insulated combination pliers 7"	
6905160	1-Insulated diagonal cutting pliers 6"	
6904160	1-Insulated long nose pliers 6"	
6912160	1-Insulated wire stripper pliers 6"	



### C50630

#### 6pc Utility set

Part no.	6/9.4/10.4/0.72'	1572g
616300	1-Engineer hammer 300gw	
616A400	1-Soft face hammer 400gw	
6982	1-Technician's scissors 145mmL	
5055P4	1-Utility knife (3pcs blades included)	
602 12150...19180	2-Chisel 12(150mmL); 19(180mmL)	



### C50631

#### 6pc Utility set

Part no.	10/10/11/0.68'	1000g
66302	1-Mini hacksaw frame 6"	
5055P3	2-Saw blade	
68601	1-LED white light, clip-type (360°rotation)	
649200C	1-Adjustable wrench 8" Approach: 38mm	
6907250	1-Insulated water pump pliers 10"	



### C51220

#### 12pc Utility set

Part no.	6/18.4/19.4/1.6'	3064g
616300	1-Engineer hammer 300gw	
616A400	1-Soft face hammer 400gw	
6907250	1-Insulated water pump pliers 10"	
614250	1-Locking pliers 10"	
649200C	1-Adjustable wrench 8" Approach: 38mm	
66302	1-Mini hacksaw frame 6"	
5055P3	2-Saw blade	
6982	1-Technician's scissors 145mmL	
5055P4	1-Utility knife (3pcs blades included)	
602 12150...19180	2-Chisel 12(150mmL); 19(180mmL)	



### C51221

#### 12pc Utility set

Part no.	6/18.4/19.2/1.6'	3031g
616300	1-Engineer hammer 300gw	
616A400	1-Soft face hammer 400gw	
613B250	1-Water pump pliers 10"	
614250	1-Locking pliers 10"	
649200C	1-Adjustable wrench 8" Approach: 38mm	
66302	1-Mini hacksaw frame 6"	
5055P3	2-Saw blade	
6982	1-Technician's scissors 145mmL	
5055P4	1-Utility knife (3pcs blades included)	
602 12150...19180	2-Chisel 12(150mmL); 19(180mmL)	



### C5136

#### 13pc Combination set

Part no.	6/19/20/1.6'	3170g
5055P3	2-Saw blade	
5055P4	1-Utility knife	
5096P8	1-5m measuring tape	
60215180Q	1-quakeproof and safe chisel 15mm (180mmL)	
604 4190Q...	3-quakeproof and safe pin punch 4(190mm); 5(200mm) 6(210mm)	
6210Q	4(190mm); 5(200mm) 6(210mm)	
614250	1-Locking pliers 10"	
616300	1-Engineer hammer	
616400	1-Rubber Hammer 280mmL	
649250A	1-Adjustable gauged wrench Jaw 29mm	
66302	1-mini hacksaw	



### C5142

#### 14pc pliers and key set

Part no.	10/14.8/15.8/0.68'	1480g
613B250	1-Waterpump pliers 10"	
610B200	1-Long Nose pliers 8"	
611B175	1-Combination pliers 7"	
612B175	1-Diagonal pliers 7"	
5102	10-Hex key 1.27; 1.5; 2; 2.5; 3; 4; 5; 6; 8; 10 mm	



### C5153

#### 15pc combination wrench set

Part no.	6/12.5/13.5/0.68'	2080g
755 08...24	15-Combination wrench 8; 10; 11; 12; 13; 14; 15; 16; 17; 18; 19; 21; 22; 23; 24 mm	



### C5166

#### 16pc Wrench and pliers set

Part no.	10/16.7/17.7/0.68'	1668g
755 06...22	13-Combination wrench 6; 7; 8; 9; 10; 11; 12; 13; 14; 15; 17; 19; 22mm	
610B160	1-Long nose pliers 6"	
611B160	1-Combination pliers 6"	
612B160	1-Diagonal pliers 6"	



**C5203**

**20pc Combination wrench set (MM & SAE)**

Part no.	6/16.7/17.7/0.68'	2780g
755 08...22	13-Combination wrench (MM) 8; 10; 11; 12; 13; 14; 15; 16; 17; 18; 19; 21; 22 mm	
755 3.8...13.16	7-Combination wrench (SAE) 3/8"; 7/16"; 1/2"; 9/16"; 5/8"; 11/16"; 13/16"	



**C5211**

**21pc Wrench and pliers set**

Part no.	10/18.4/19.4/0.68'	1839g
754 0607...2022	8-Double open end wrench 6x7; 8x9; 10x11; 12x13; 14x15; 16x17; 18x19; 20x22 mm	
5102	10pc Hex key	
764 0127...10	1.27; 1.5; 2; 2.5; 3; 4; 5; 6; 8; 10 mm	
6903180	1-Insulated combination pliers 7"	
6904160	1-Insulated long nose pliers 6"	
6905160	1-Insulated diagonal cutting pliers 6"	



**C5541**

**54pc Cordless drill & wrench set**

Part no.	4/23.4/24.4/1.6'	5839g
827A31	3pc Cordless drill package (including Charger and battery)	
825B144	1-Extra spare battery	
(2421F)	14-1/4" DR. 6pt. Flank socket	
525 032...14	3.2; 4; 4.5; 5; 5.5; 6; 7; 8; 9; 10; 11; 12; 13; 14 mm	
	20-1/4" bit 25mmL	
12325 04...065	Slotted 4; 5.5; 6.5 mm	
12425 03...08	Hex 3; 4; 5; 6; 8 mm	
12125 1...3	Phillips PH.1; PH.2; PH.3	
12225 1...3	Pozidriv PZ.1; PZ.2; PZ.3	
12625 10...40	Star T10; T15; T20; T25; T30; T40	
802218	1-Flexible ratchet handle	
8042 050...150	2-Extension 2" & 6"	
80521	1-Universal joint	
81022	1-Bit holder 1/4"(F)x1/4"(F)	
8143	1-Spinner	
80632	1-Adaptor for extension 3/8"(F)x1/4"(M)	
81225	1-Magnetic socket pick up	
5084	8-Double open end wrench	
754 0607...2022	6x7; 8x9; 10x11; 12x13; 14x15; 16x17; 18x19; 20x22 mm	

**50222S**

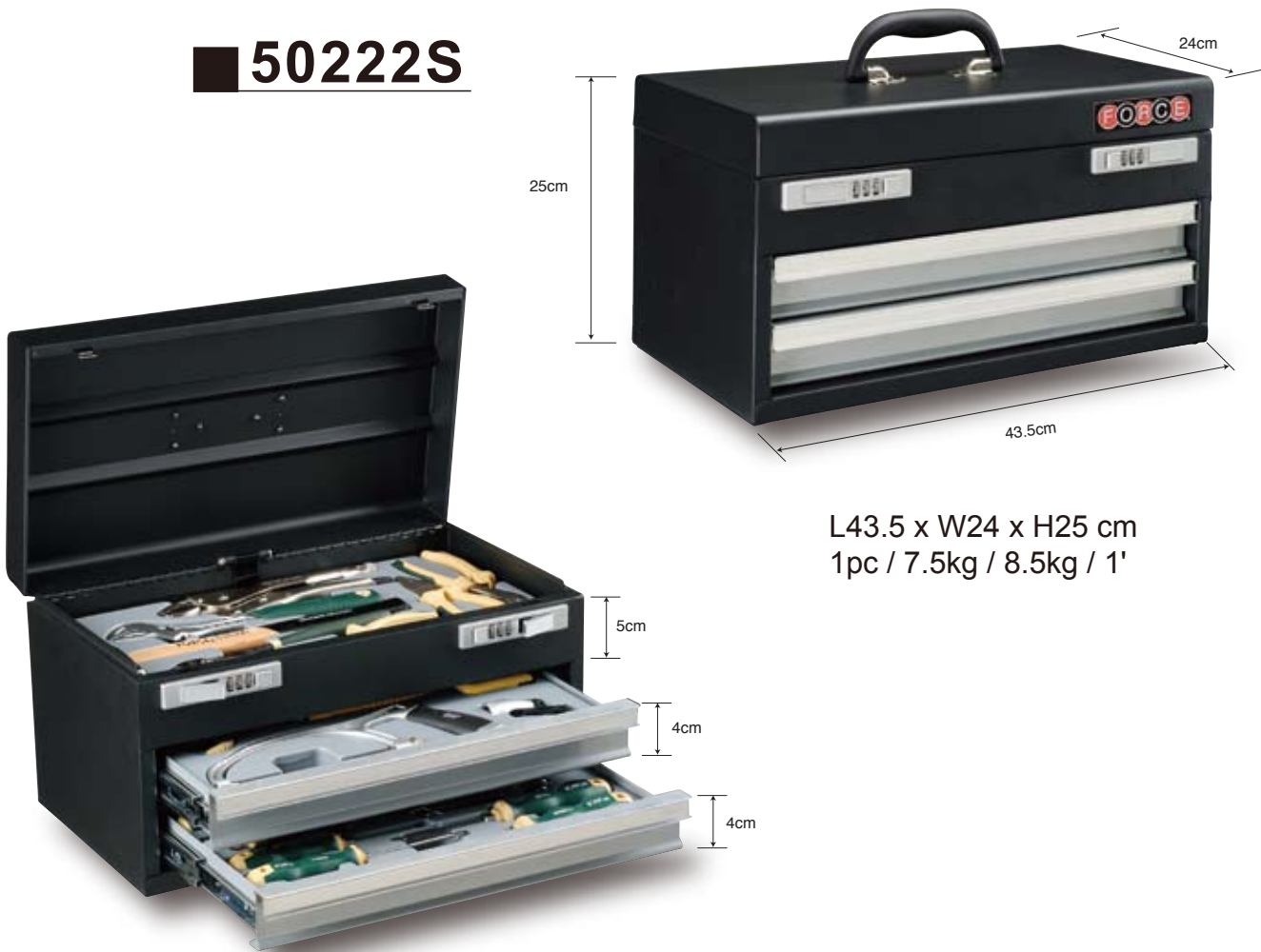

L43.5 x W24 x H25 cm  
1pc / 7.5kg / 8.5kg / 1'

**50222S-38**



50715



50716

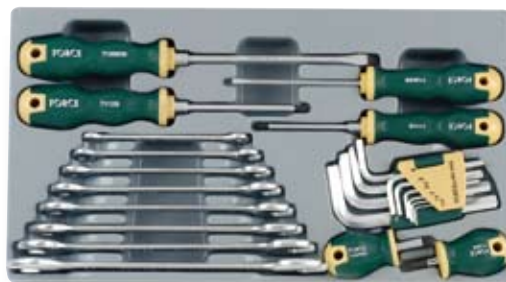

2242

**50222S-47**



5174



50632



2242V

**50222S-56**



50715



2207



2293





## 2207

### 20pc Screwdriver & L key set

Part no.	5/6.4/7.4/1.3'	1285g
711 1B...2B	2-Phillips screwdriver PH.1x80mmL; PH.2x100mmL	
7112BS	1-Stubby phillips screwdriver PH.2x25mmL	
713 04B..065B	2-Slotted screwdriver 4mmx100mmL; 6.5mmx150mmL	
713065BS	1-Stubby slotted screwdriver 6.5mmx25mmL	
5102	10pc Hex key	
764 0127...10	1.27; 1.5; 2; 2.5; 3; 4; 5; 6; 8; 10 mm	
5096P8	1-Measuring tape 5M	
68601	1-LED white light, clip-type (360° rotation)	
6982	1-Technician's scissors 145mmL	
5055P4	1-Utility knife (3pcs blades included)	

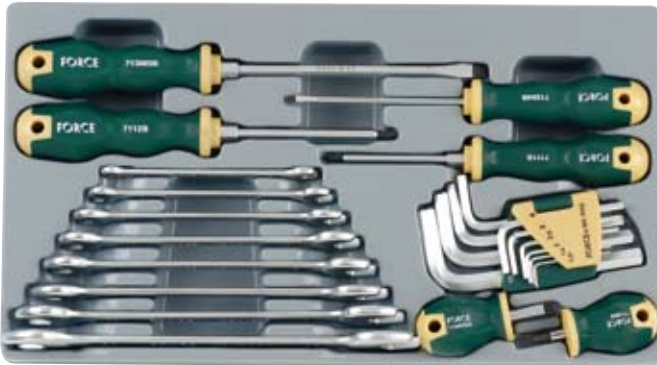

## 2242

### 24pc Screwdriver & wrench set

Part no.	5/8.4/9.4/1.3'	1673g
711 1B...2B	2-Phillips screwdriver PH.1x80mmL; PH.2x100mmL	
7112BS	1-Stubby phillips screwdriver PH.2x25mmL	
713 04B..065B	2-Slotted screwdriver 4mmx100mmL; 6.5mmx150mmL	
713065BS	1-Stubby slotted screwdriver 6.5mmx25mmL	
754 0607...2022	8-Double open end wrench 6x7; 8x9; 10x11; 12x13; 14x15; 16x17; 18x19; 20x22 mm	
5102	10pc Hex key	
764 0127...10	1.27; 1.5; 2; 2.5; 3; 4; 5; 6; 8; 10 mm	



## 2242V

### 24pc Screwdriver & wrench set (EVA foam)

Part no.	5/8/9/1.3'	1626g
711 1B...2B	2-Phillips screwdriver PH.1x80mmL; PH.2x100mmL	
7112BS	1-Stubby phillips screwdriver PH.2x25mmL	
713 04B..065B	2-Slotted screwdriver 4mmx100mmL; 6.5mmx150mmL	
713065BS	1-Stubby slotted screwdriver 6.5mmx25mmL	
754 0607...2022	8-Double open end wrench 6x7; 8x9; 10x11; 12x13; 14x15; 16x17; 18x19; 20x22 mm	
5102	10pc Hex key	
764 0127...10	1.27; 1.5; 2; 2.5; 3; 4; 5; 6; 8; 10 mm	



**2293**

**29pc 1/4" Socket combination and wrench**

Part no.	5/8.1/9.1/1.3'	1613g
<b>Content: 1/4"DR.</b>		
525 04...13	10-6pt Flank socket 4; 5; 6; 7; 8; 9; 10; 11; 12; 13 mm	
80222	1-Ratchet handle	
8032115	1-Sliding T handle 115mmL	
8042 050..100	2-Extension 2"; 4"	
80521	1-Universal joint	
8148	1-Spinner	
755 06...22	13-Combination wrench 6; 7; 8; 9; 10; 11; 12; 13; 14; 15; 17; 19; 22 mm	



**50632**

**6pc Utility set**

Part no.	5/6.4/7.4/1.3'	1286g
616300	1-Engineer hammer 300gw	
613B250	1-Water pump pliers 10"	
6982	1-Technician's scissors 145mmL	
5055P4	1-Utility knife (3pcs blades included)	
5096P8	1-Measuring tape 5M	
68601	1-LED white light, clip-type (360°rotation)	



**50715 (Only for 50222S toplayer)**

**7pc Hammer and pliers set**

Part no.	5/11.9/12.9/1.3'	2388g
616300	1-Engineer hammer 300gw	
614250	1-Locking pliers 10"	
613B250	1-Water pump pliers 10"	
610B160	1-Long nose pliers 6"	
611B160	1-Combination pliers 6"	
612B160	1-Diagonal pliers 6"	
649250A	1-Adjustable gauged wrench 10"	



**50716**  
7pc Utility set

Part no.	5/4.1/5.1/1.3'	826g
6982	1-Technician's scissors 145mmL	
5055P4	1-Utility knife (3pcs blades included)	
5096P8	1-Measuring tape 5M	
68601	1-LED white light, clip-type (360°rotation)	
66302	1-Mini hacksaw frame 6"	
5055P3	2-Saw blade	



**5174 (Only for 50222S toplayer)**  
17pc Cordless screwdriver & pliers set

Part no.	5/9.4/10.4/1.3'	1875g
828A21	3pc 1/4" Cordless screwdriver package (charge and battery included)	
21112	11pc 1/4" bit	
12125 1...3	Phillips bit PH.1; PH.2x2; PH.3 (25mmL)	
12225 1...3	Pozidriv bit PZ.1; PZ.2x2; PZ.3 (25mmL)	
12325 055...065	Slotted bit 5.5; 6.5mm (25mmL)	
81260Q	Magnetic quick-release holder	
610B160	1-Long nose pliers 6"	
611B160	1-Combination pliers 6"	
612B160	1-Diagonal pliers 6"	

**50223S**



L57 x W23 x H30.5 cm  
1pc / 12.5kg / 14kg / 1.5'



**50223S-103**



4721



20914



51210FV



51012

**50223S-109**



5262



2146



3451V



5243



**4721 (Only for 50223S toplayer)**

**72pc 1/4" & 1/2"DR. Socket set**

Part no.	5/20.1/21.1/1.3'	4021g
	<b>Content:</b>	
	<b>1/4"DR.</b>	
529 04...13	12-12pt. Flank socket 4; 4.5; 5; 5.5; 6; 7; 8; 9; 10; 11; 12; 13mm	
52950 08...13	3-12pt. Flank deep socket 8; 10; 13 mm 28-bit (30mmL)	
12130 0...3	Phillips PH.0; PH.1; PH.2; PH.3	
12230 0...3	Pozidriv PZ.0; PZ.1; PZ.2; PZ.3	
12330 04...07	Slotted 4; 5; 5.5; 6; 7 mm	
12430 02...10	Hex 2; 3; 4; 5; 6; 7; 8; 10 mm	
12630 10...40	Star T10; T15; T20; T25; T27; T30; T40	
80521	1-Universal joint	
802215	1-Ratchet handle	
8032115	1-Sliding T handle 115mmL	
8042050	1-Extension 2"	
81022	1-Bit Holder 1/4"(F)x1/4"(F)	
81022M	1-Magnetic bit Holder 1/4"(F)x1/4"(F)	
8143	1-Spinner	
	<b>1/2"DR. part</b>	
549 14...32	13-12pt. Flank socket 14; 15; 16; 17; 18; 19; 20; 21; 22; 24; 27; 30; 32 mm	
54977 17...21	3-12pt. Flank deep socket 17; 19; 21 mm	
80243	1-Ratchet handle	
8044 075...250	2-Extension 3"; 10"	
8044125W	1-Wobble extension 5"	
80541	1-Universal joint	
80634	1-Adaptor for Extension 3/8"(F) x 1/2"(M)	

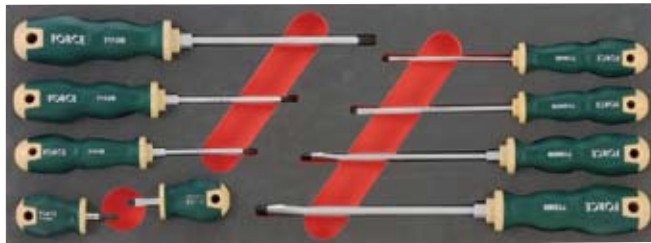

## 20914

### 9pc Screwdriver set

Part no.	5/6.0/7.0/0.8'	1200g
711 1B...3B	<b>Content:</b> 3-Phillips screwdriver PH.1(80mmL); PH.2(100mmL); PH.3(150mmL)	
7112BS	1-Stubby Phillips screwdriver PH.2(25mmL)	
7130 4B...08B	4-Slotted screwdriver 4mm(100mmL); 5.5mm(120mmL); 6.5mm(150mmL); 8mm(175mmL)	
713065BS	1-Stubby slotted screwdriver 6.5mm(25mmL)	



## 51210FV

### 12pc Flexible gear wrench set

Part no.	5/9.7/10.7/0.8'	1938g
757 08F...19F	<b>Content:</b> 12-Flexible gear wrench 8mm; 9mm; 10mm ; 11 mm; 12mm; 13mm; 14mm; 15mm; 16mm; 17mm; 18mm; 19mm	



## 51012

### 10pc Utility set

Part no.	5/9.0/10.0/0.8'	1815g
60212150	<b>Content:</b> 1-Chisel 12mm (150mmL)	
603150	1-Cape chisel (150mmL)	
604 3150...4190	2-Pin Punch 3mm (150mmL); 4mm (190mmL)	
6074185	1-Center pinch 4(185mmL)	
610B200	1-Long Nose pliers 8"	
611B175	1-Combination pliers 7"	
612B175	1-Diagonal pliers 7"	
613B250	1-Waterpump pliers 10"	
616200	1-Engineer hammer 200gw	

## 5262 (Only for 50223S toplayer)

### 26pc Pliers set



Part no.	5/4.1/5.1/1.3'	3828g
5093XLB	9pc Hex ball point extra long key(MM)	
765 015XL...10XL	1.5; 2; 2.5; 3; 4; 5; 6; 8; 10 mm	
5093XLBS	9pc Hex ball point extra long key(SAE)	
765 1.16XL...3.8XL	1/16"; 5/64"; 3/32"; 1/8"; 5/32"; 3/16"; 1/4"; 5/16"; 3/8"	
610B200	1-Long Nose pliers 8"	
611B175	1-Combination pliers 7"	
612B175	1-Diagonal pliers 7"	
649250A	1-Adjustable gauged wrench 10"	
613250	1-Water pump pliers 10"	
673B215	1-Slip joint pliers 8"	
614250	1-Locking pliers 10"	
615225	1-Long nose locking pliers 9"	

## 2146

### 14pc Screwdriver & impact driver set



Part no.	5/4.1/5.1/1.3'	1520g
<b>Content: 3/8" DR.</b>		
713 03B...08B	6-Slotted screwdrivers 3mm(75mmL); 3.5mm(100mmL) 4mm(100mmL); 5.5mm(125mmL) 6.5mm(150mmL) ; 8mm(175mmL)	
711 1B...2B	2-Phillips screwdrivers PH.1 (80mmL) ; PH.2(100mmL)	
8174	1-Impact driver	
81045A	1-Bit holder 1/2"DR.x5/16" 4-5/16" bit (36mmL)	
15336 09...11	Slotted bit 9; 11 mm	
15136 2..3	Phillips bit PH.2; PH.3	



### 3451V

#### 45pc Socket combination set

Part no.	5/4.1/5.1/1.3'	3900g
535 08...22	15-6pt. Flank socket (MM) 8; 9; 10; 11; 12; 13; 14; 15 16; 17; 18; 19; 20; 21; 22 mm	
53563 08...22	11-6pt. Flank deep socket (MM) 8; 9; 10; 11; 12; 13; 14; 16; 17; 19; 22 mm	
535 3.8...13.16	5-6pt. Flank socket (SAE) 3/8"; 1/2"; 9/16"; 11/16"; 13/16"	
53563 3.8...13.16	5-6pt. Flank deep socket (SAE) 3/8"; 1/2"; 9/16"; 11/16"; 13/16"	
8073 16...20.6	3-Spark plug socket 16; 18; 20.6 mm	
802311	1-Ratchet handle	
8013200B	1-Bent flex handle	
8043 075...150	2-Extension 3" & 6"	
80643	1-Adaptor for extension 1/2"F to 3/8"M	
80531	1-Universal joint	



### 5243

#### 24pc Combination wrench (S&M)

Part no.	5/4.1/5.1/1.3'	2854g
755 08...23	12-Combination wrench (MM) 8; 10; 11; 12; 13; 14; 15; 16; 17; 19; 22; 23 mm	
755 1.4...15.16	12-Combination wrench (SAE) 1/4"; 5/16"; 3/8"; 7/16"; 1/2"; 9/16"; 5/8"; 11/16"; 3/4"; 13/16"; 7/8"; 15/16"	



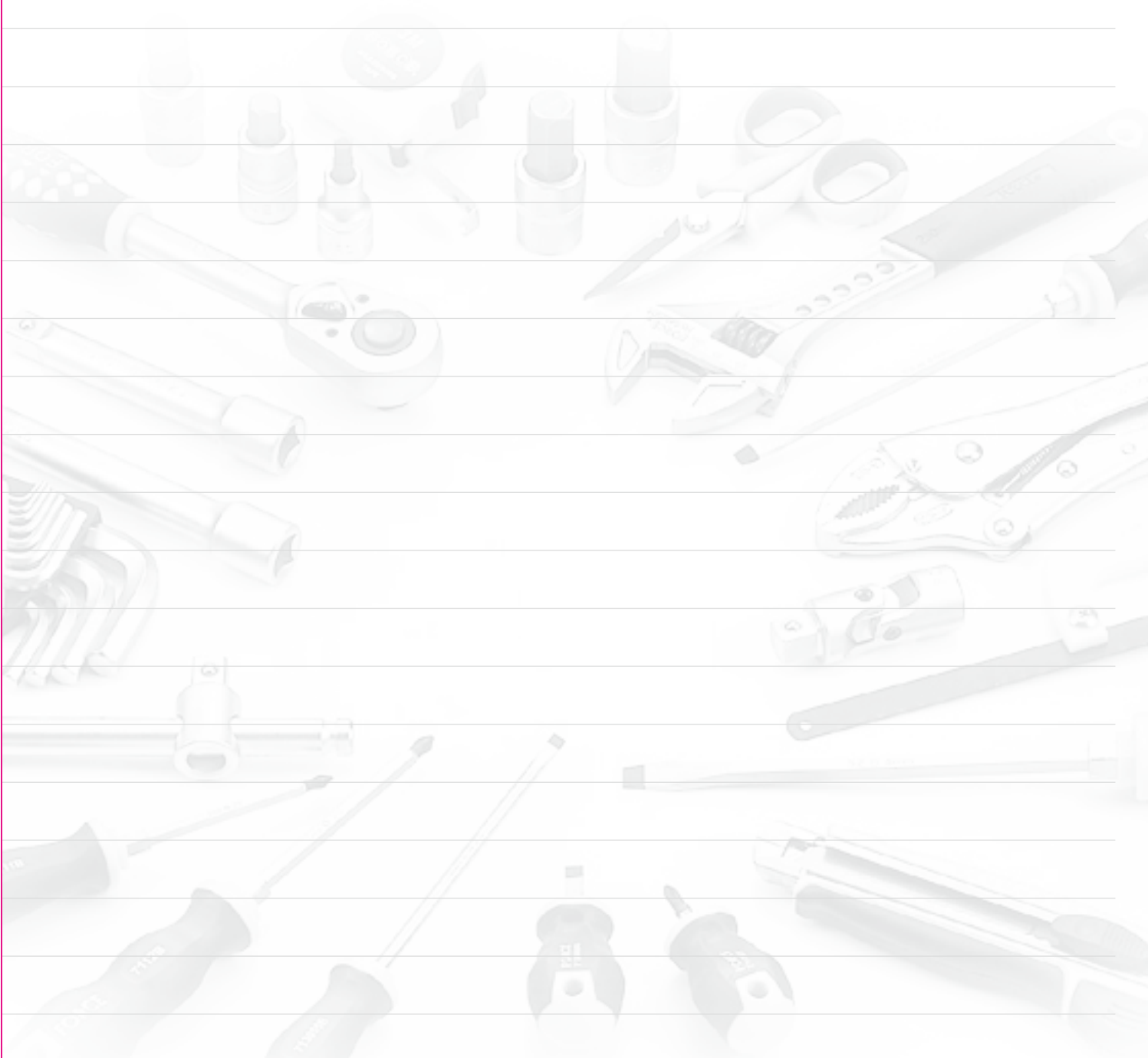

**50229S**



L65 x W30.5 x H44.5 cm  
1pc / 27.5kg / 29kg / 3.3'



**50229S-94**

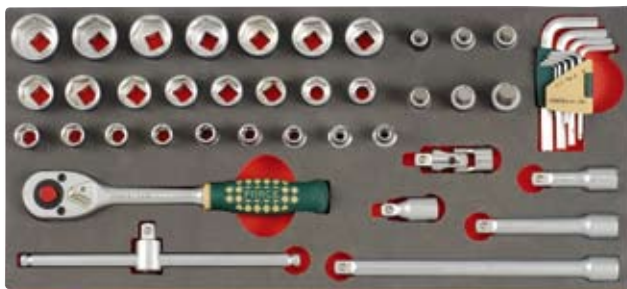

4461

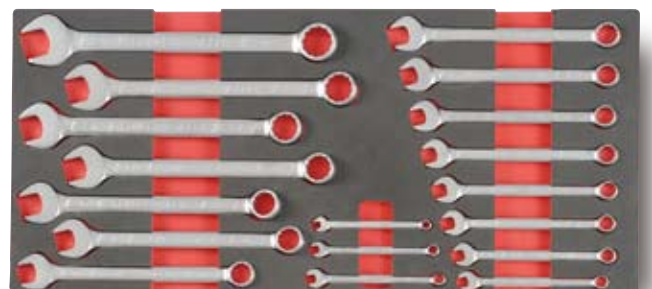

5185



5205



2033



5024



5039



5021V

**50229S-255**



2145



31101



4572



5281

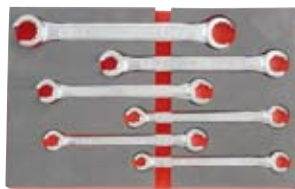

5066V

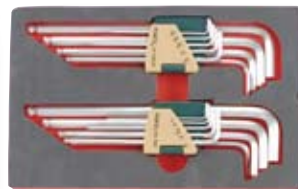

5184



5066SV



5043AV



51223



**2033**



**3pc Insulated screwdriver set**

Part no.	Content:	209g
7111N	1-Insulated slotted screwdriver 4(100mmL)	
71304N	1-Inculated Phillips screwdriver PH.1(80mmL)	
88401	1-Screwdriver probe voltage tester Testing range: 110~250V AC	

**2145 (Only for 50229S toplayer)**

**14pc Screwdriver and pliers set**



Part no.	Content:	2443g
713 03B...08B	6-Slotted screwdrivers 3mm(75mmL); 3.5mm(100mmL) 4mm(100mmL); 5.5mm(125mmL) 6.5mm(150mmL) ; 8mm(175mmL)	
711 1B...2B	2-Phillips screwdrivers PH.1 (80mmL) ; PH.2(100mmL)	
649 200B...300B	2-Adjustable gauged wrench 8"(200mmL); 12"(300mmL)	
610B200	1-Long Nose pliers 8"	
610B200B	1-Bent long Nose pliers 8"	
611B175	1-Combination pliers 7"	
612B175	1-Diagonal pliers 7"	

**4461 (Only for 50229S toplayer)**

**46pc 1/2" DR. Socket Combination set**

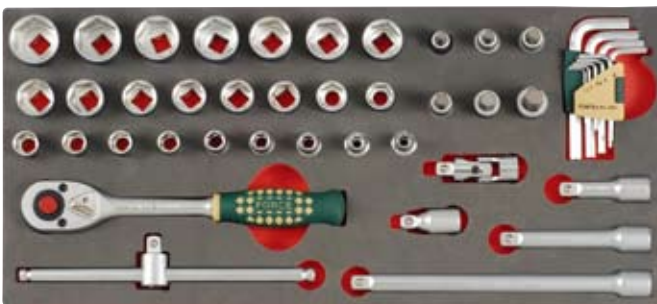

Part no.	Content:	5208g
545 08...32	24-6pt. Flank socket 8; 9; 10; 11; 12; 13; 14; 15; 16; 17; 18; 19; 20; 21; 22; 23; 24; 25; 26; 27; 28; 29; 30; 32 mm	
344050 07...12	6-Hex socket bit 7; 8; 9; 10; 12 mm (55mmL)	
34406514	14 mm (65mmL)	
80242	1-Ratchet handle	
8034250	1-Sliding T handle 10"(250mmL)	
8044 075...250	3-Extension 3" & 5" & 10"	
8044050W	1-Wobble extension 2"	
80541	1-Universal joint	
5093	9pc Hex key	
764 015...10	1.5; 2; 2.5; 3; 4; 5; 6; 8; 10 mm	



**31101**

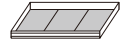

**110pc 1/4" & 3/8" Socket combination set(S&M)**

Part no.	4759g
<b>Content: 1/4" &amp; 1/2" DR.</b>	
<b>1/4"DR.</b>	
525 04...14	13-6pt. Flank Socket (MM) 4 ; 4.5 ; 5 ; 5.5 ; 6 ; 7 ; 8 9 ; 10 ; 11 ; 12 ; 13 ; 14 mm
525 3.16...9.16	10-6pt. Flank Socket (SAE) 3/16" ; 7/32" ; 1/4" ; 9/32" ; 5/16" 11/32" ; 3/8" ; 7/16" ; 1/2" ; 9/16"
802222	1-72 teeth round ratchet handle
8042 050...150	2-Extension 2" & 6"
80622	1-Adaptor for extension 1/4"DR.(F)x1/4"DR(M)
80521	1-Universal joint
8145	1-Spinner handle with square hole end
81022	1-Bit holder 1/4"DR.x1/4"
8111	1-Flexible extension
2331	33pc 1/4" Security bit in frame
81260	Magnetic bit holder (60mmL)
121S25 06...10	Torq set bit 6; 8; 10 mm
123S25 04...10	Spanner bit 4; 6; 8; 10 mm
122S25 01...04	1/4" Tri-wing bit 1; 2; 3; 4
124S25 02...06	1/4" Hex security bit 2; 2.5; 3; 4; 5; 6 mm
124S25 5.32...5.64	1/4" Hex security bit 5/32"; 9/64"; 1/8"; 7/64"; 3/32"; 5/64"
12725 08...40	1/4" Star tamperproof bit T-8H; T-10H; T-15H; T-20H; T-25H; T-27H;T-30H; T-35H; T-40H
<b>3/8"Part</b>	
535 08...22	15-6pt. Flank socket (MM) 8; 9; 10; 11; 12; 13; 14; 15 16; 17; 18; 19; 20; 21; 22 mm
53563 08...22	11-6pt. Flank deep socket (MM) 8; 9; 10; 11; 12; 13; 14; 16; 17; 19; 22 mm
535 3.8...13.16	5-6pt. Flank socket (SAE) 3/8"; 1/2"; 9/16"; 11/16"; 13/16"
53563 3.8...13.16	5-6pt. Flank deep socket (SAE) 3/8"; 1/2"; 9/16"; 11/16"; 13/16"
8073 16...20.6	3-Spark plug socket 10; 12; 14 mm (16; 18; 20.6 mm)
802322	1-Ratchet handle
8013200B	1-Bent flex handle
8043 075...150	2-Extension 3" & 6"
80643	1-Adaptor for extension 1/2"F to 3/8"M
80531	1-Universal joint
6473420W	1-Lock Torque wrench - window display (Tone control) 70-100 Nm



**4572**

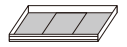

**57pc 1/2"DR. Socket combination set(S&M)**

Part no.		2757g
<b>Content: 1/2"DR.</b>		
545 10...32	18-6pt. Flank Socket (MM) 10; 11; 12; 13; 14; 15; 16; 17; 18; 19; 20; 21; 22; 23; 24; 27; 30; 32 mm	
545 3.8...1.1.4	13-6pt. Flank socket (SAE) 3/8"; 7/16"; 1/2"; 9/16"; 5/8"; 11/16"; 13/16"; 7/8"; 15/16"; 1"; 1-1/8"; 1-3/16"; 1-1/4"	
802422	1-72teeth ratchet handle	
8044 125...250	2-Extension bar 5" & 10"	
8074 16...20.6	2-Spark plug socket 16mm & 20.6mm	
8034250	1-Sliding T bar	
80541	1-Universal joint	
8154410	1-Speed handle	
	9-Hex socket bit(MM)	
344055 04...12	4; 5; 6; 7; 8; 10; 12; (55mmL)	
34406514	14; (65mmL)	
34407017	17mm(70mmL)	
	9-Hex socket bit (SAE)	
344055 5.32...1.2	5/32"; 3/16"; 7/32"; 1/4"; 5/16"; 3/8"; 1/2" (55mmL)	
3440065 9.16...5.8	9/16"; 5/8" (65mmL)	



**5021V**

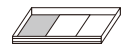

**2pc Pliers set**

Part no.		522g
<b>Contents:</b>		
613250	1-Waterpump pliers 10"	
614250	1-Locking pliers 10"	



**5024**



**2pc Utility set**

Part no.		1010g
<b>Contents:</b>		
649200C	1-Adjustable wrench 8" Approach: 38mm	
5055P4	1-Utility knife (3pcs blades included)	



### 5039

#### 3pc Pliers set

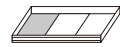

Part no.	766g	
<b>Content:</b>		
612B175	1-Diagonal pliers 7"	
610B200	1-Long Nose pliers 8"	
611B175	1-Combination pliers 7"	

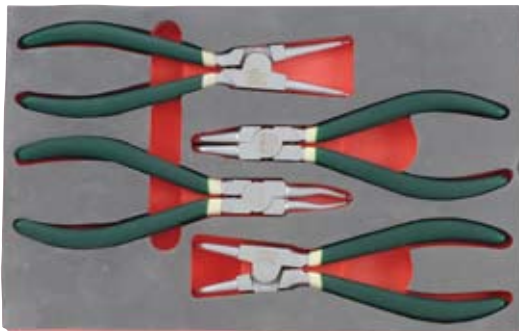

### 5043AV

#### 4pc Circlip pliers set



Part no.	1800g	
<b>Content:</b>		
4-Circlip pliers		
609ASO	External straight tip 1.8mm for opening	
609ASC	Internal straight tip 1.8mm for closing	
609ABO	External 90° Bent tip 1.8mm for opening	
609ABC	Internal 90° Bent tip 1.8mm for closing	

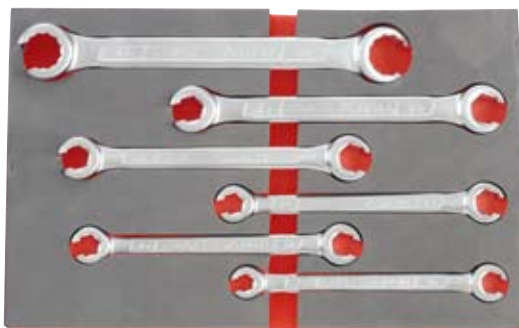

### 5066V

#### 6pc Flare nut wrench set (MM)



Part no.	684g	
751 0810...1719	6-Flare nut wrench set (MM) 8x10; 10x11; 10x12; 11x13; 12x14; 17x19 mm	



### 5066SV

#### 6pc Flare nut wrench set (SAE)



Part no.	684g	
<b>Content:</b>		
751 0810S...	6-Flare nut wrench set (SAE)	
1719S	5/16"x3/8"; 3/8"x7/16"; 7/16"x1/2"; 1/2"x9/16"; 5/8"x3/4"; 11/16"x3/4"	



**51223**

**12pc Impact driver and pin punch set**



Part no.		1244g
	<b>Content:</b>	
8174	1-Impact driver	
	4-5/16" bit (36mmL)	
15336 09...11	Slotted bit 9, 11 mm	
15136 2..3	Phillips bit PH.2, PH.3	
81045A	1-Bit holder 1/2"DR.x5/16"	
50613	6pc Pin punch in frame	
604 2140...8215	2mm (140mmL); 3mm (150mmL); 4mm (190mmL); 5mm (200mmL); 6mm (210mmL); 8mm (215mmL)	

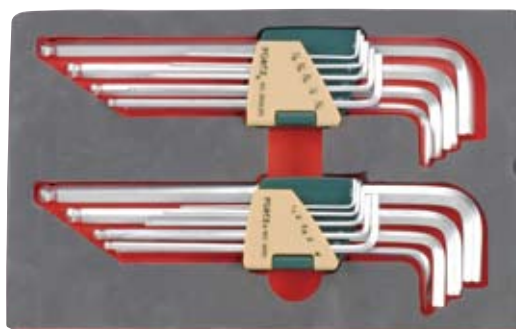

**5184**

**18pc Hex ball point extra long key set (MM&SAE)**



Part no.		1000g
5093XLB	9pc Hex ball point extra long key set(MM)	
765 015XL...10XL	1.5; 2; 2.5; 3; 4; 5; 6; 8; 10; mm	
5093XLBS	9pc Hex ball point extra long key set(SAE)	
765 1.16XL...3.8XL	1/16"; 5/64"; 3/32"; 1/8"; 5/32"; 3/16"; 1/4"; 5/16"; 3/8"	

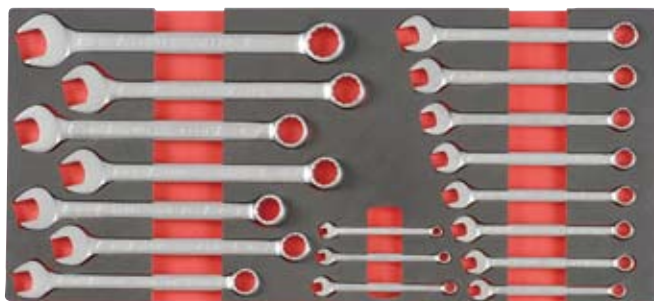

**5185**

**18pc Combination wrench set**



Part no.		2132g
	<b>Content:</b>	
755 06...24	18-Combination wrench	
	6;7;8;9;10;11;12;13;14;15;16;17;18; 19;20;21;22;24 mm	





**5205**

**28pc Combination wrench set (S&M)**



Part no.	Content:	3366g
616500	1-Engineer hammer 500gw	
616A400	1-Soft face hammer 400gw	
88601	1-Demagnetizer/Magnetizer	
711 1M...2M	2-Hammer Phillips Screwdrivers PH.1(80mmL) ; PH.2(100mmL)	
71304B	1-Slotted screwdriver 4mm(100mmL)	
713 055M...065	2-Hammer Slotted Screwdrivers 5.5mm(125mmL) ; 6.5mm(150mmL)	
606 2185...4185	3-Taper punch 2(185mmL); 3(185mmL); 4(185mmL)	
607 4185...8185	2-Center punch 4(185mmL);8(185mmL)	
604 2140...4190	3-Pin punch 2(140mmL); 3(150mmL);4(190mmL)	
602 12150...25220	3-Chisel 12(150mmL);19(220mmL);25(220mmL)	
603150	1-Cape Chisel 150mmL	



**5281**

**28pc Combination wrench set (S&M)**



Part no.	Content:	4322g
755 10...32	14-Combination wrench (MM) 10; 11; 12; 13; 14; 17; 19; 21; 22; 23; 24; 27; 30; 32	
755 5.16...1.1.4	14-Combination wrench (SAE) 5/16"; 3/8"; 7/16"; 1/2"; 9/16"; 5/8"; 11/16"; 3/4"; 13/16"; 7/8"; 15/16"; 1"; 1-1/8"; 1-1/4"	



## 50253

Heavy-duty workbench with drawers & fiberboard

1pc / 110.4kg / 117.3kg / 14.8'

With 10 pcs of 82023U 3" U-shaped hooks and

10 pcs of 82023S 3" single hooks.

With 3-drawer tool box 50223.



### 50253-177

#### 1st Drawer

T2084B ; T2641 ; T3251-5 ; T4214

#### 2nd Drawer

T5046 ; T5038 ; T5043A ; T5053

#### 3rd Drawer

T5055 ; T5161 ; T5131 ; T5096

\* Tools in the cabinet are not included.  
\* For detail, refer to P.3-12



## 50254

Heavy-duty workbench with drawers & lockable cabinet

1pc / 141kg / 148kg / 20'

With 10 pcs of 82023U 3" U-shaped hooks and

10 pcs of 82023S 3" single hooks.

With 3-drawer tool box 50223.



### 50254-177

#### 1st Drawer

T2084B ; T2641 ; T3251-5 ; T4214

#### 2nd Drawer

T5046 ; T5038 ; T5043A ; T5053

#### 3rd Drawer

T5055 ; T5161 ; T5131 ; T5096

\* Tools in the cabinet are not included.  
\* For detail, refer to P.3-12

**50223**



**50223R**

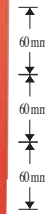

L70 x W47 x H34 cm  
1pc / 27.4kg / 29.3kg / 5.9'

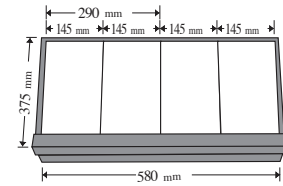

**10225**



**10225R**



L69 x W46 x H49 cm  
1pc / 39.3kg / 42kg / 8.2'

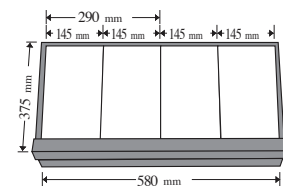

# Practical series

## Packaged Accessories



**102103**  
ABS top tray



Height-adjustable handle



- Strong caster with brake
- Plastic corner for protection



Plastic-under provides coldness isolation for hand



Can holder

## Optional Accessories



**102104**  
Side table



**102105**  
Paper holder

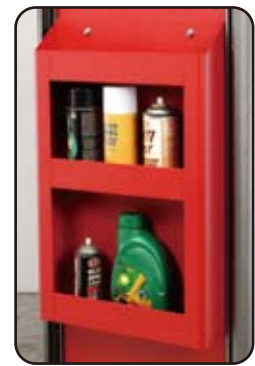

**102102**  
Side shelf



**102101**  
Side lock cabinet

■ 10215



■ 10215A

■ 10215B



■ 10215R

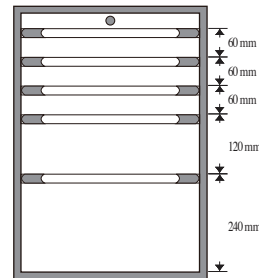
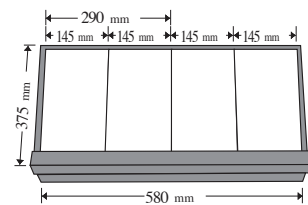

L80 x W50 x H103 cm  
1pc / 75kg / 80kg / 16'

■ 10216B



■ 10216R

■ 10216A



■ 10216

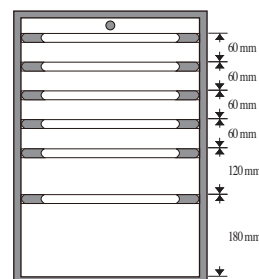
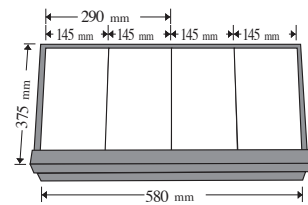

L80 x W50 x H103 cm  
1pc / 75kg / 80kg / 16'

**10217A**



**10217**

**10217R**



**10217B**

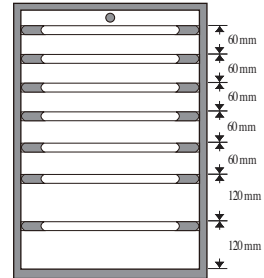
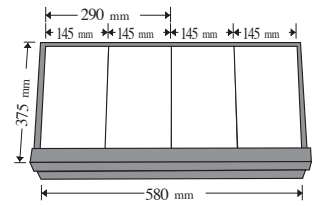

L80 x W50 x H103 cm  
1pc / 75kg / 80kg / 16'

**10218R**



**10218B**

**10218**



**10218A**

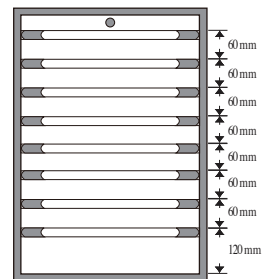
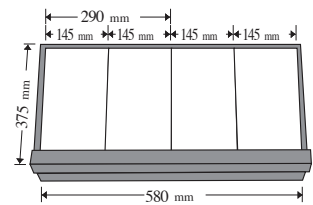

L80 x W50 x H103 cm  
1pc / 75kg / 80kg / 16'

**10318R**

**10318B**

**10318**

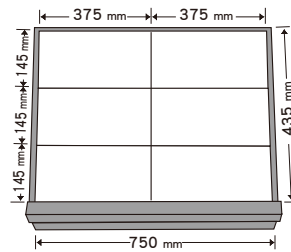

L95 x W50 x H103 cm  
1pc / 107kg / 117kg / 20.8'

**50212**  
Service Cart







# Premium series

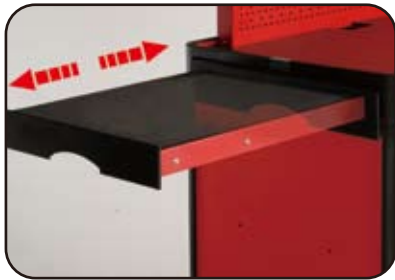

Embedded side table



Embedded fiberboard



Solid-grip handle

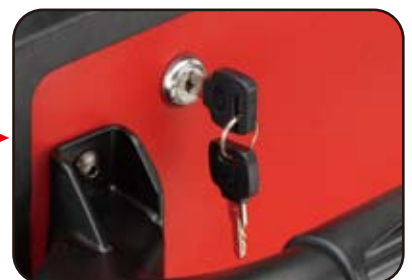
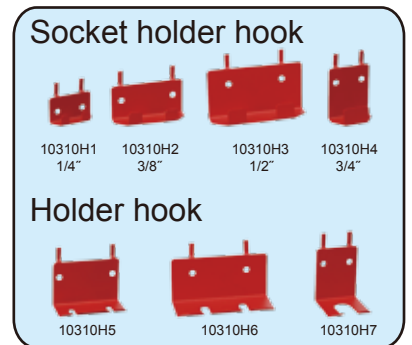

Key hole on the side

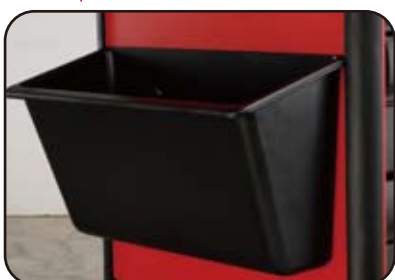

Trash can



Can holder



Strong caster with brake

**10617**



**10617R**

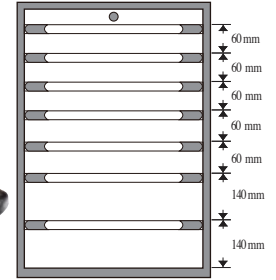
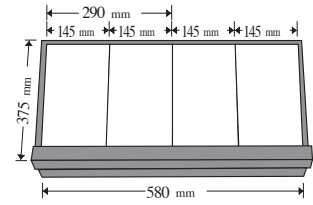

L70 x W49 x H100 cm  
1pc / 75kg / 80kg / 14'

**10617B**

**10617G**

**10618**



**10618B**

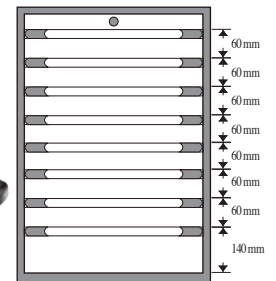
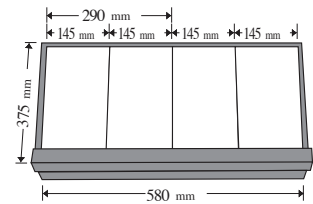

L70 x W49 x H100 cm  
1pc / 75kg / 80kg / 14'

**10618R**

**10618G**

# 154PC Tool Set(MM)

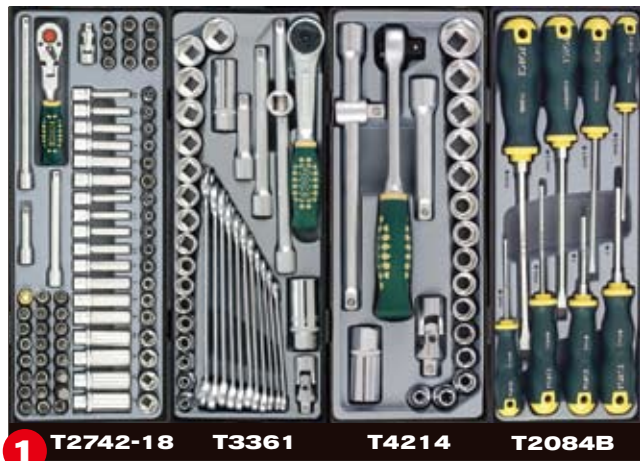

Apply tool box



■ 50223 ■ 50223R



■ 10225R ■ 10225



■ 10215 ■ 10215R

■ 10215B ■ 10215A



■ 10216R ■ 10216

■ 10216B ■ 10216A



■ 10217B ■ 10217

■ 10217R ■ 10217A



■ 10218A ■ 10218

■ 10218R ■ 10218B



■ 10617 ■ 10617G



■ 10617R ■ 10617B



■ 10618B ■ 10618



■ 10618G ■ 10618R

# 177PC Tool Set

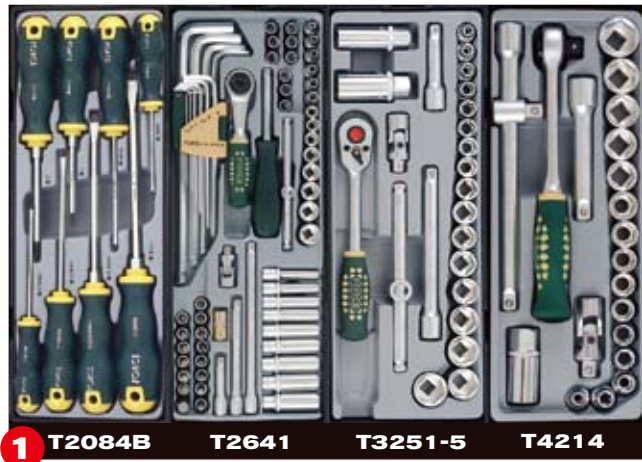

**1** T2084B T2641 T3251-5 T4214



**2** T5046 T5038 T5043A T5053



**3** T5055 T5161 T5131 T5096

Apply tool box



■ 50223R ■ 50223



■ 10225 ■ 10225R



■ 10215 ■ 10215R



■ 10216R ■ 10216

■ 10215B ■ 10215A

■ 10216B ■ 10216A



■ 10217B ■ 10217



■ 10218A ■ 10218

■ 10217R ■ 10217A

■ 10218R ■ 10218B



■ 10617 ■ 10617R



■ 10618R ■ 10618

■ 10617B ■ 10617G

■ 10618B ■ 10618G

# 180PC Tool Set(MM)

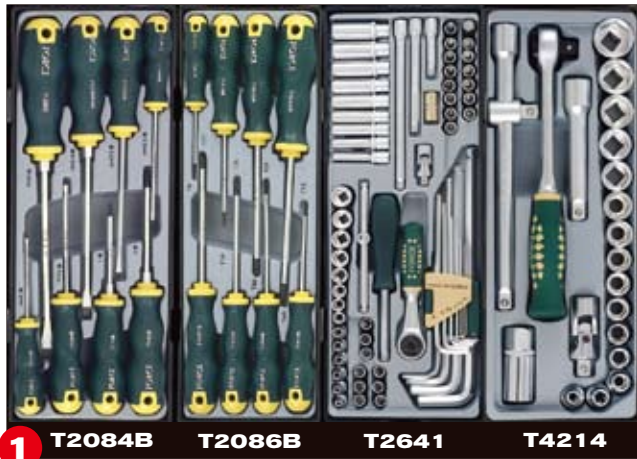

Apply tool box



■ 50223 ■ 50223R



■ 10225R ■ 10225



■ 10215A ■ 10215R



■ 10216 ■ 10216R

■ 10215B ■ 10215

■ 10216B ■ 10216A



■ 10217R ■ 10217



■ 10218B ■ 10218

■ 10217B ■ 10217A

■ 10218R ■ 10218A



■ 10617B ■ 10617R



■ 10618G ■ 10618

■ 10617 ■ 10617G

■ 10618B ■ 10618R

# 219PC Tool Set(MM)

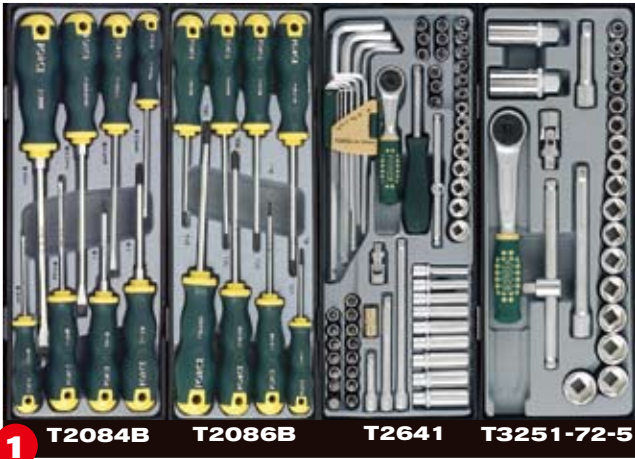

Apply tool box



■ 50223R ■ 50223



■ 10225 ■ 10225R



■ 10215 ■ 10215R



■ 10216R ■ 10216

■ 10215B ■ 10215A

■ 10216B ■ 10216A



■ 10217B ■ 10217



■ 10218A ■ 10218

■ 10217R ■ 10217A

■ 10218R ■ 10218B



■ 10617 ■ 10617R



■ 10618R ■ 10618

■ 10617B ■ 10617G

■ 10618B ■ 10618G

# 179PC Tool Set(MM)



Apply tool box



■ 10225R ■ 10225



■ 10215 ■ 10215R

■ 10215B ■ 10215A



■ 10216R ■ 10216

■ 10216B ■ 10216A



■ 10217B ■ 10217

■ 10217R ■ 10217A



■ 10218A ■ 10218

■ 10218R ■ 10218B



■ 10617G ■ 10617R

■ 10617B ■ 10617



■ 10618R ■ 10618

■ 10618B ■ 10618G



# 225PC Tool Set(SAE)



**1** 2142

2137

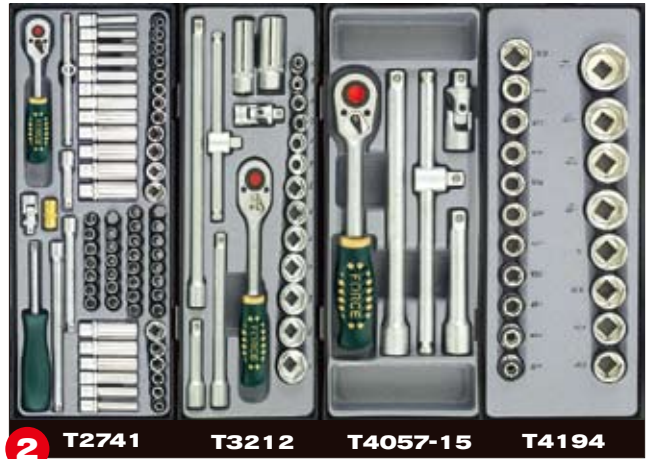

**2** T2741

T3212

T4057-15

T4194



**3** T5134

T5111S

T5079S

T4322



**4** T5046

T5043A

T5038

T5053

Apply tool box



■ 10225 ■ 10225R



■ 10215A ■ 10215R

■ 10215B ■ 10215



■ 10216 ■ 10216R

■ 10216B ■ 10216A



■ 10217R ■ 10217

■ 10217B ■ 10217A



■ 10218B ■ 10218

■ 10218R ■ 10218A



■ 10617R ■ 10617B

■ 10617 ■ 10617G



■ 10618G ■ 10618

■ 10618B ■ 10618R

# 245PC Tool Set(MM)



**1** 2142 T2086B T2641

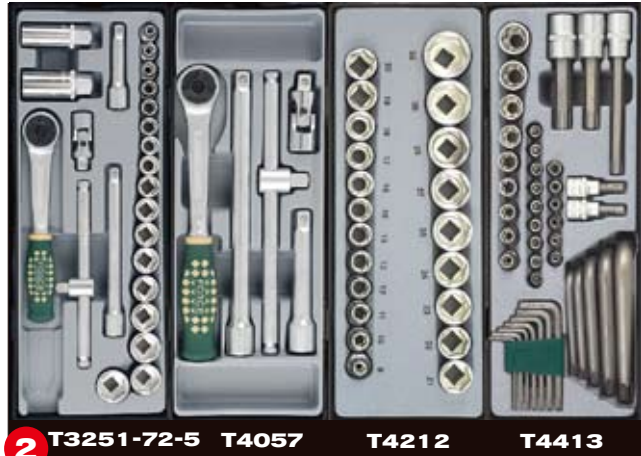

**2** T3251-72-5 T4057 T4212 T4413



**3** T5161 T5111 T5081 T5074



**4** T5038 T5046 T5053 T5131

Apply tool box



■ 10225 ■ 10225R



■ 10215A ■ 10215R



■ 10216 ■ 10216R

■ 10215B ■ 10215

■ 10216B ■ 10216A



■ 10217R ■ 10217



■ 10218B ■ 10218



■ 10617R ■ 10617B



■ 10618G ■ 10618

■ 10217B ■ 10217A

■ 10218R ■ 10218A

■ 10617 ■ 10617G

■ 10618B ■ 10618R

# 247PC Tool Set(MM)



**1** 2142 2137

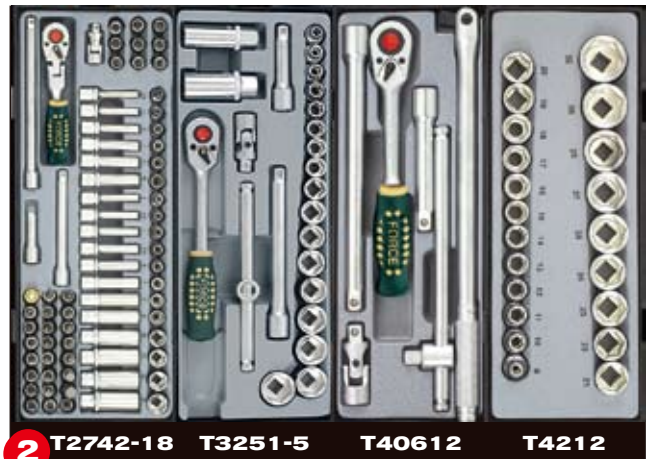

**2** T2742-18 T3251-5 T40612 T4212



**3** T4322 T5181 T5111 T5081



**4** T5046 T5038 T5053 T5131

Apply tool box



■ 10225R ■ 10225



■ 10215 ■ 10215R

■ 10215B ■ 10215A



■ 10216R ■ 10216

■ 10216B ■ 10216A



■ 10217B ■ 10217

■ 10217R ■ 10217A



■ 10218A ■ 10218

■ 10218R ■ 10218B



■ 10617G ■ 10617R

■ 10617B ■ 10617



■ 10618R ■ 10618

■ 10618B ■ 10618G

# 201 PC Tool Set(MM)



Apply tool box

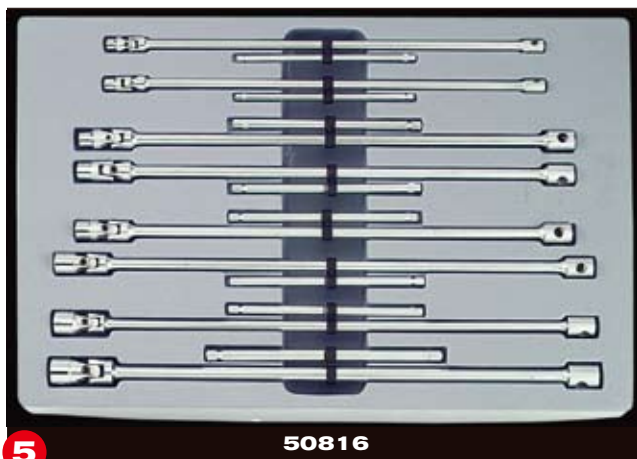

Apply tool box

■ 10215

■ 10215B

■ 10217A

■ 10217R



■ 10215A

■ 10215R

■ 10217

■ 10217B

■ 10216B

■ 10216A

■ 10218R

■ 10218



■ 10216R

■ 10216

■ 10218B

■ 10218A

■ 10617

■ 10617R

■ 10618

■ 10618B



■ 10617B

■ 10617G

■ 10618R

■ 10618G

# 284PC Tool Set(MM)

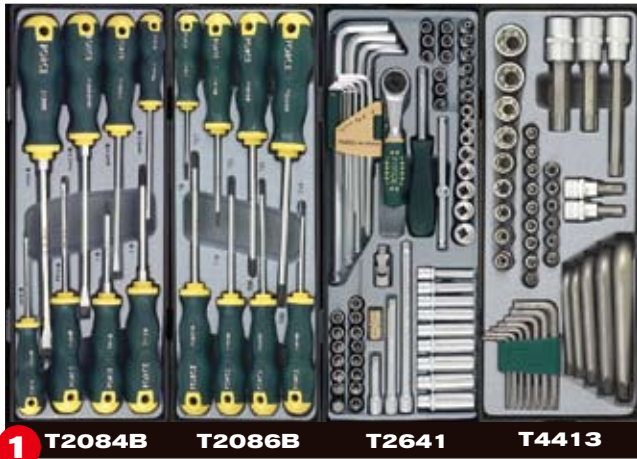

Apply tool box



■ 10216B



■ 10216R



■ 10216



■ 10216A



■ 10217A



■ 10217



■ 10217R



■ 10217B



■ 10218R



■ 10218B



■ 10218



■ 10218A



■ 10617



■ 10617R



■ 10618



■ 10618B



■ 10617B



■ 10617G



■ 10618R



■ 10618G

# 286PC Tool Set(MM)

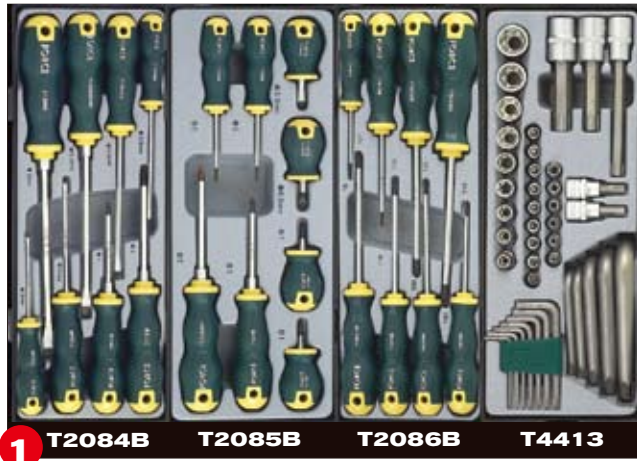

**1** T2084B T2085B T2086B T4413

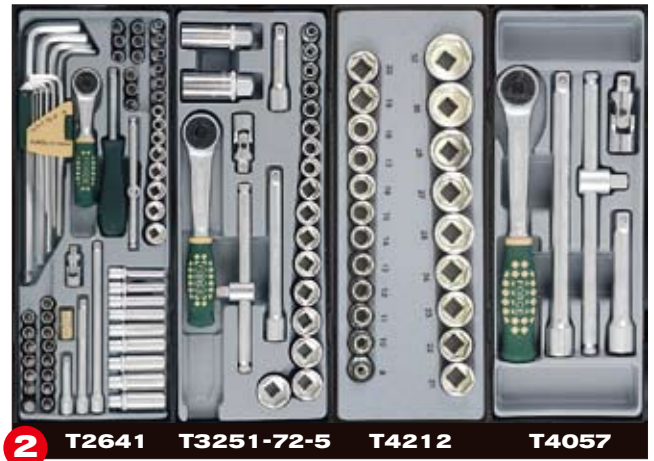

**2** T2641 T3251-72-5 T4212 T4057



**3** T5161 T5052 T5111 T5082



**4** T5074 T5033 T5081 T5044



**5** T5053 T5038 T5046 T5131

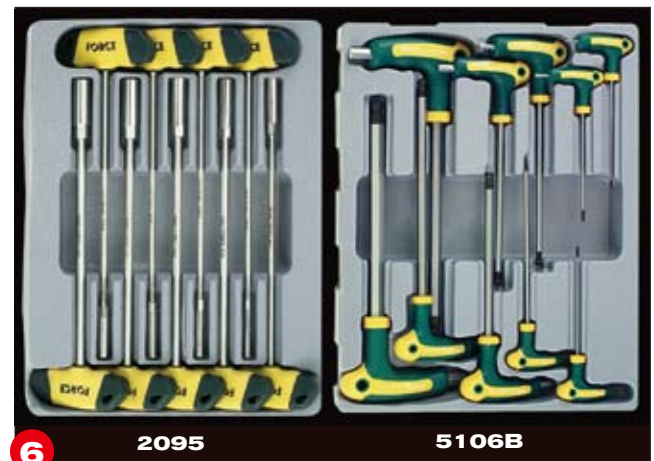

**6** 2095 5106B



Apply tool box



10216B



10216R



10216



10216A



10217A



10217



10217R



10217B



10218R



10218B



10218



10218A



10617



10617R



10618



10618B



10617B



10617G



10618R



10618G

# 290PC Tool Set(SAE)

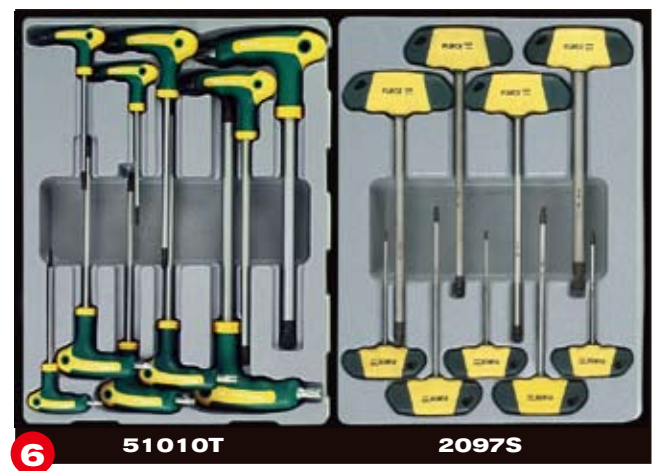
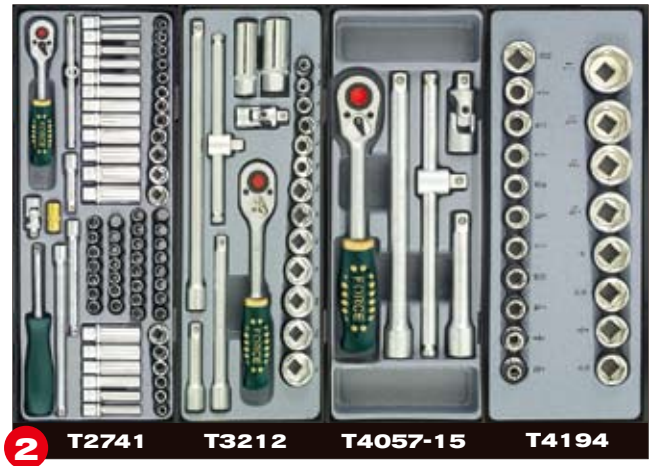
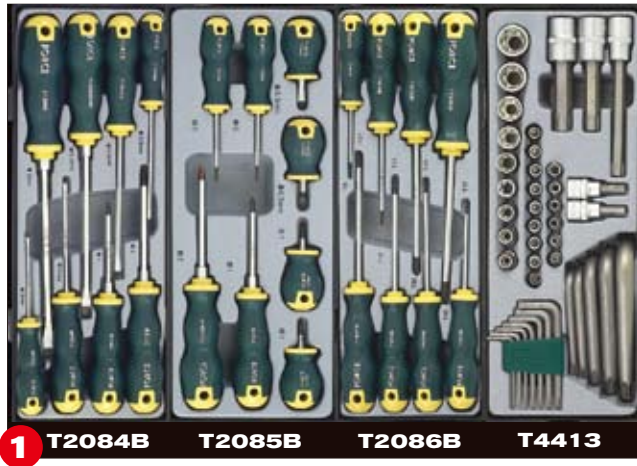

Apply tool box



10216B



10216R



10216



10216A



10217A



10217



10217R



10217B



10218R



10218B



10218



10218A



10617



10617R



10618



10618B

10617B

10617G

10618R

10618G

# 296PC Tool Set (MM)



**1** T2084B T2085B T2086B T4413



**2** T2641 T3251-72-5 T4057 T4212



**3** T5161 T5052 T5164R T5082



**4** T5111 T5074 T5131 T5056



**5** T5038 T5046 T5053 T5043A

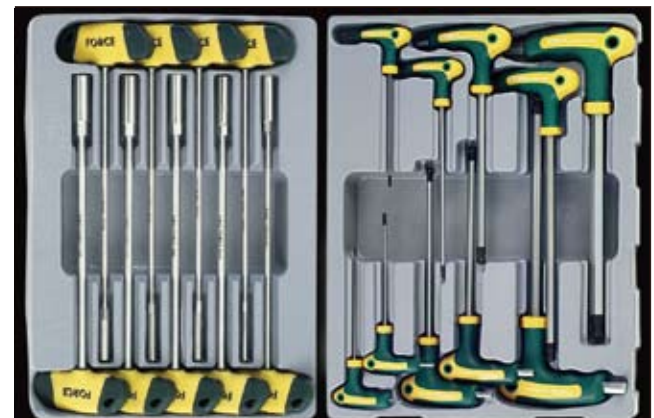

**6** 2095 5106B

Apply tool box



■ 10216B



■ 10216R



■ 10216



■ 10216A



■ 10217A



■ 10217



■ 10217R



■ 10217B



■ 10218R



■ 10218B



■ 10218



■ 10218A

■ 10617



■ 10617R



■ 10618



■ 10618B



■ 10617B



■ 10617G



■ 10618R



■ 10618G

# 325PC Tool Set (SAE & MM)

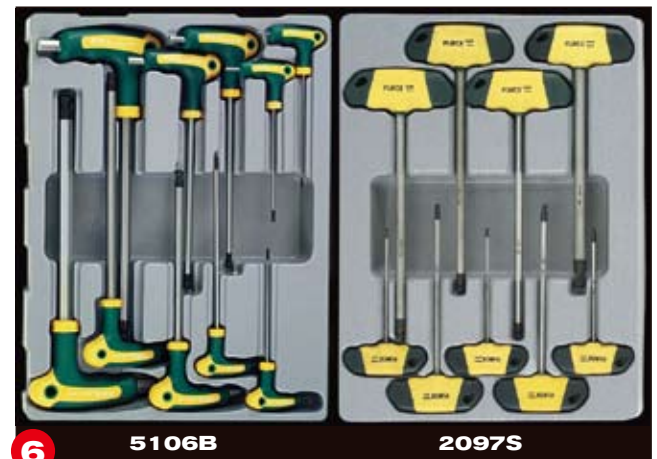
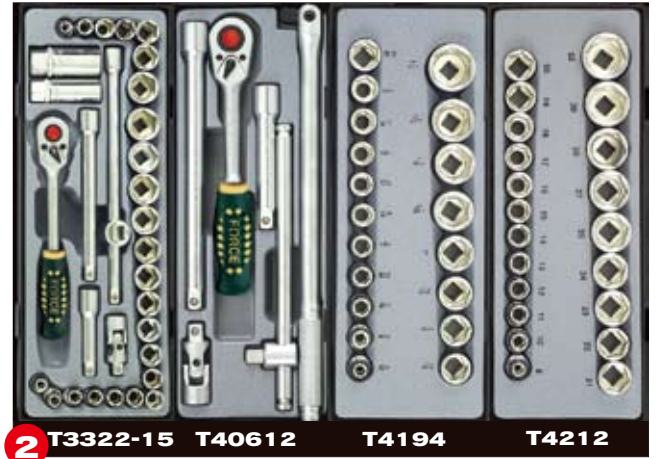

Apply tool box



■ 10216B



■ 10216R



■ 10216



■ 10216A



■ 10217A



■ 10217



■ 10217R



■ 10217B



■ 10218R



■ 10218B



■ 10218



■ 10218A

■ 10617

■ 10617R

■ 10618

■ 10618B



■ 10617B



■ 10617G



■ 10618R



■ 10618G

# 361 PC Tool Set (MM)

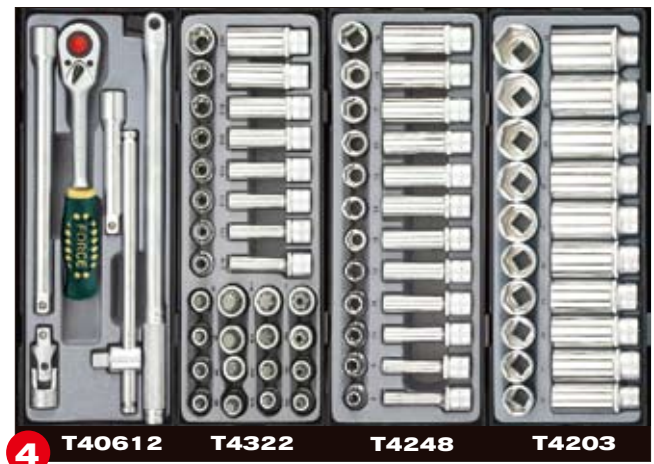
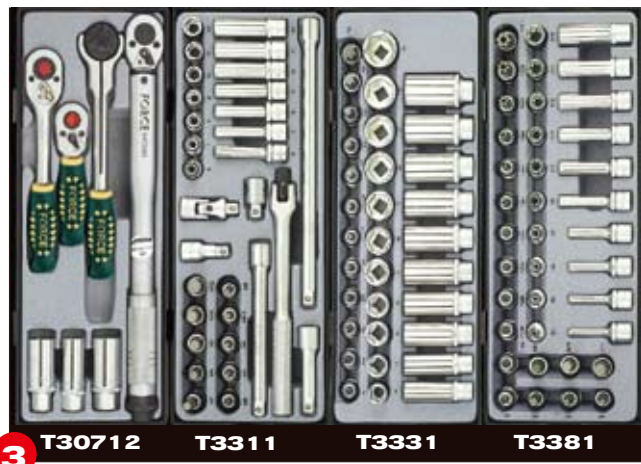
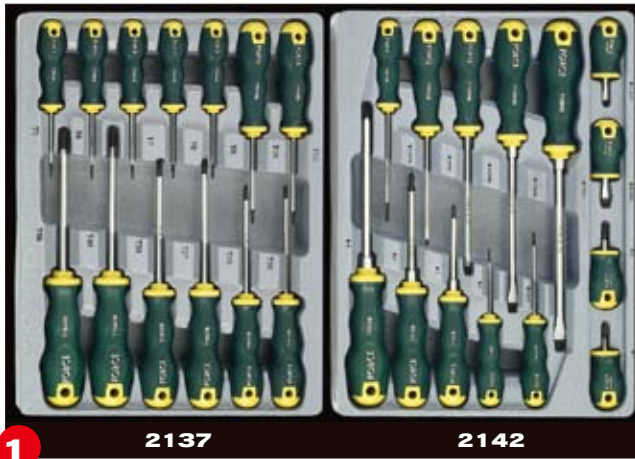



Apply tool box



■ 10216B



■ 10216R



■ 10216



■ 10216A



■ 10217A



■ 10217



■ 10217R



■ 10217B



■ 10218R



■ 10218B



■ 10218



■ 10218A



■ 10617



■ 10617R

■ 10617G



■ 10618

■ 10618R



■ 10618B

■ 10618G

■ 10617B

# 376PC Tool Set (MM)

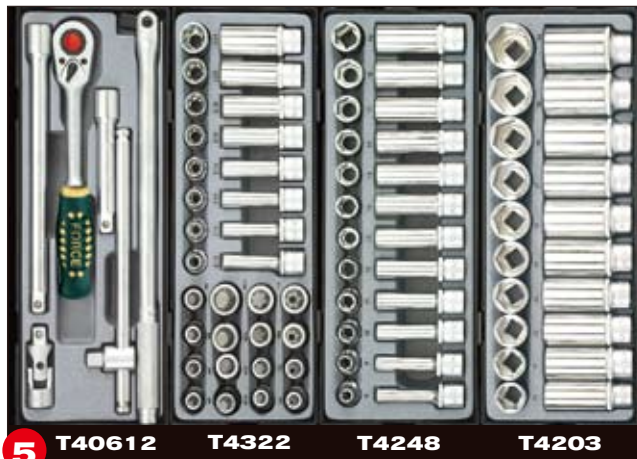
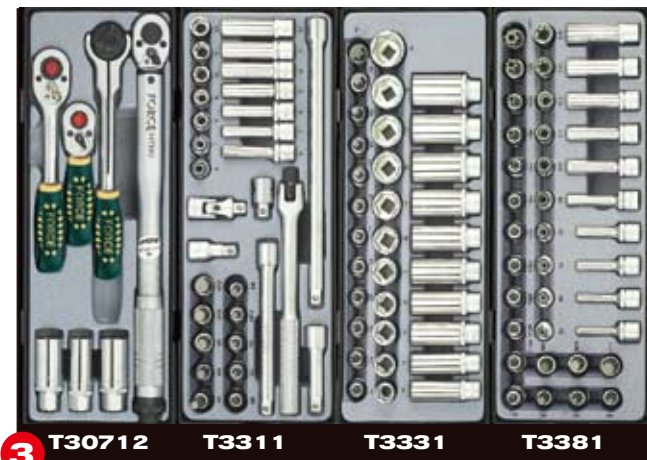

Apply tool box



■ 10216B



■ 10216R



■ 10216



■ 10216A



■ 10217A



■ 10217



■ 10217R



■ 10217B



■ 10218R



■ 10218B



■ 10218



■ 10218A

■ 10617



■ 10617R



■ 10618



■ 10618B



■ 10617B



■ 10617G



■ 10618R



■ 10618G

# 562PC Tool Set (MM)



**1** T5038 T5046 T5055 T5053



**2** T5111 T5082 T5172 T5331



**3** T4413 T5122 T4119 T4193



**4** T5057 T51811 T50814 T5047



**5** 5048 54111



**6** 2142 2137



**7** T2046 T2742 T5161 T5052



**8** T30712 T3311 T3331 T3381

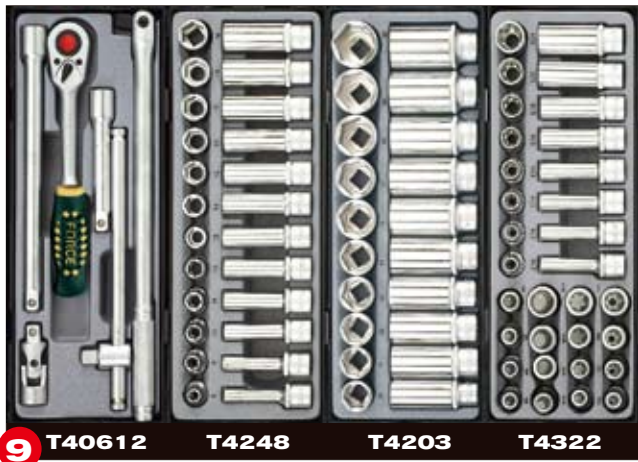

**9** T40612 T4248 T4203 T4322

Apply tool box

**1013R**



**10** T5081 T5044 T5074 T5033



**1013**



**11** T5043A T5131 T5096 T5056

# 431 PC Tool Set (SAE & MM)

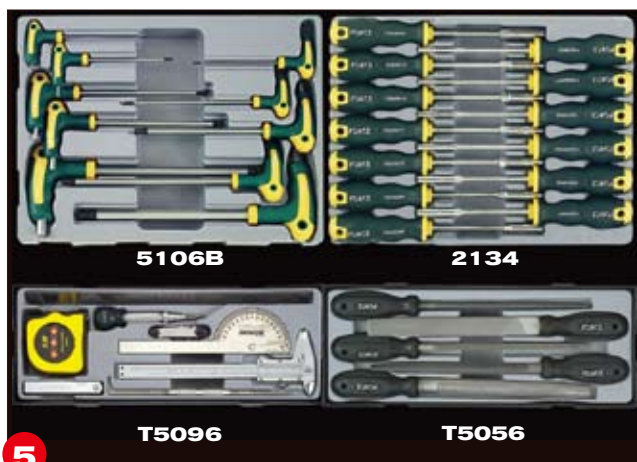
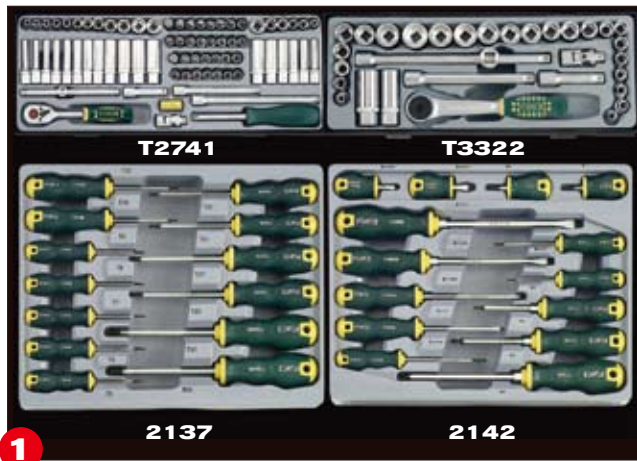

Apply tool box

■ **10318R**

■ **10318B**

■ **10318**

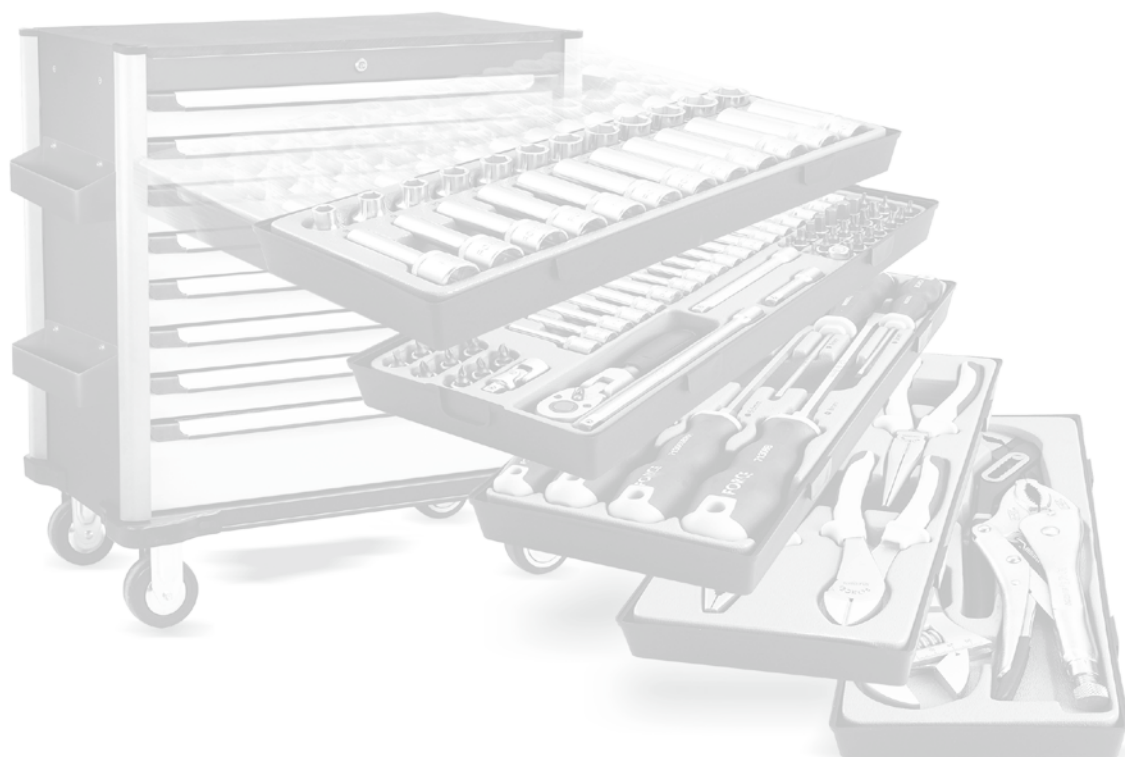

# 437PC Tool Set (MM)

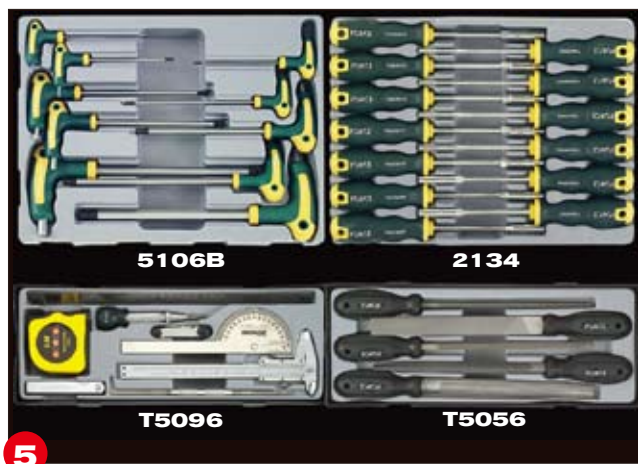



Apply tool box

■ 10318R

■ 10318B

■ 10318

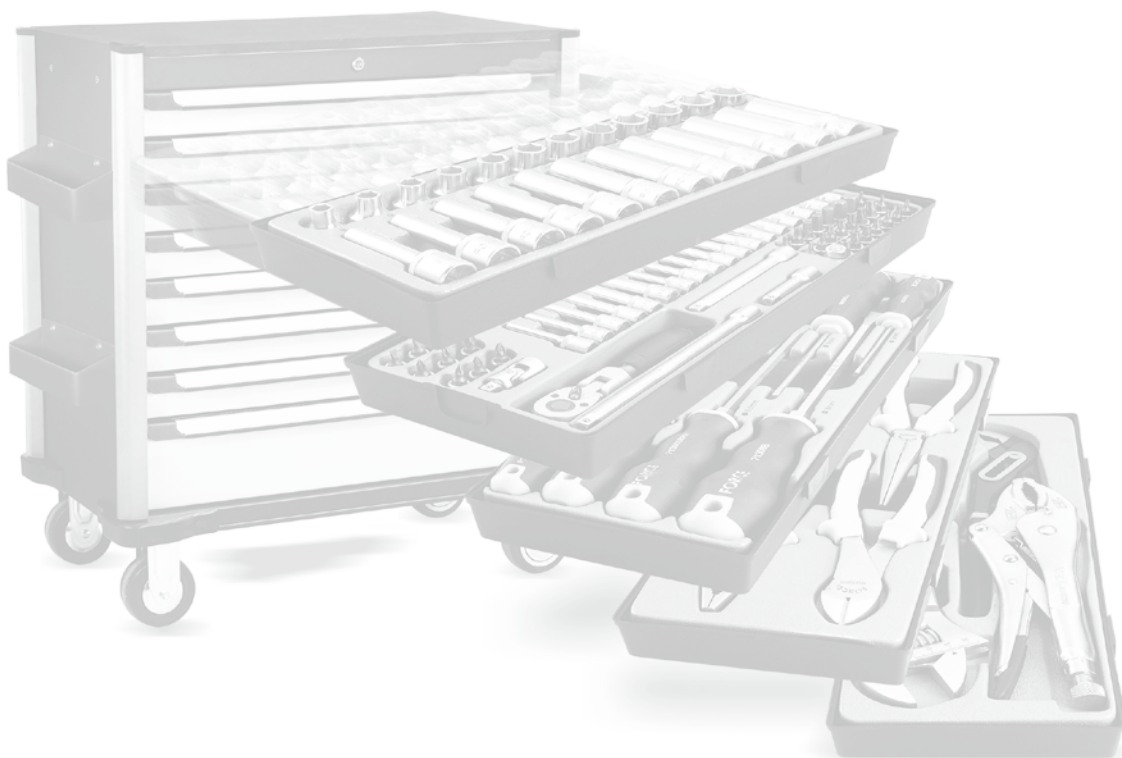

# 492PC Tool Set (MM)





7

Apply tool box

■ 10318R

■ 10318B

■ 10318



# 552PC Tool Set (SAE & MM)

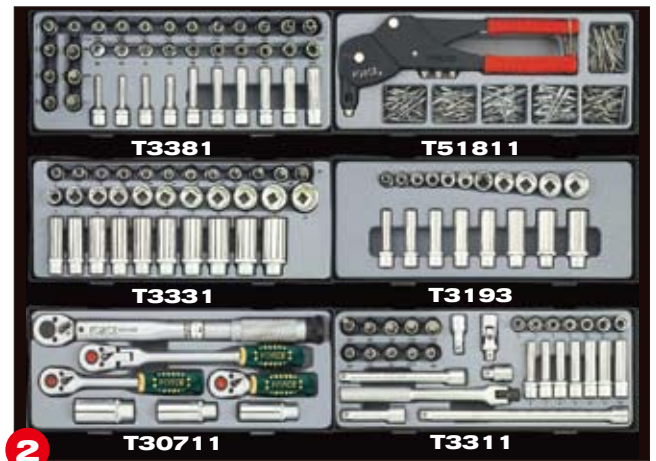

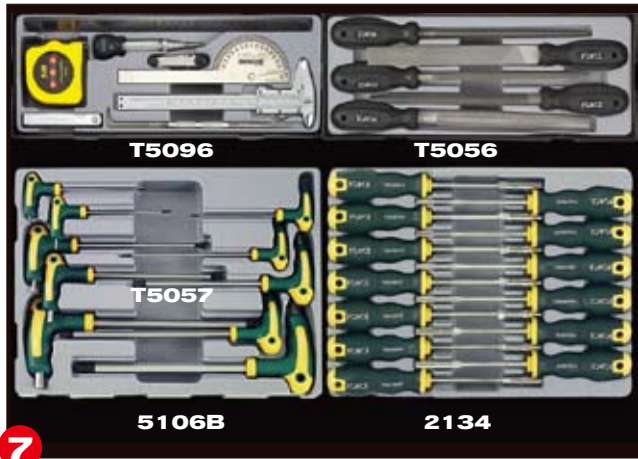

Apply tool box





## T2045

### 4pc Ratchet handle set



Part no.	6/7.3/8.3/0.9'	1220g
6472270	Content: 1/4"DR	
802215	1-Torque wrench(tone control)	
802219	1-20 teeth Ratchet handle	
802218	1-20 teeth Stubby ratchet handle	
	1-20 teeth Flexible ratchet handle	



## T2046

### 4pc Ratchet handle set



Part no.	6/7.5/8.5/0.9'	1230g
6472300W	Content:	
	1-Lock torque wrench-- window display(tone control)	
80222	1-24 teeth Ratchet handle	
802219	1-20 teeth Stubby ratchet handle	
802223	1-72 teeth Flexible ratchet handle	



## T20712

### 7pc Insulated screwdriver set



Part no.	10/7.5/8.5/1.1'	750g
711 1N...2N	Content:	
	2-Insulated Phillips screwdriver PH.1(80mmL); PH.2(100mmL)	
713 03N...	4-Insulated slotted screwdriver	
065N	3(100mmL); 4(100mmL); 5.5(125mmL); 6.5(150mmL)	
2125P1	1-Induction circuit tester	



## T20715

### 7pc Insulated screwdriver set



Part no.	10/5.5/6.5/1.1'	550g
711 1N...2N	Content:	
	2-Insulated Phillips screwdriver PH.1; PH.2	
713 024N...065N	5-Insulated slotted screwdriver	
	2.5mm(75mmL); 3mm(100mmL); 4mm(100mmL); 5.5mm(125mmL); 6.5mm(150mmL)	



## T20718

### 7pc Insulated screwdriver set

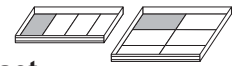

Part no.	10/6.8/7.8/1.1'	675g
711 1N...2N	Content: 2-Insulated Phillips screwdriver PH.1(80mmL); PH.2(100mmL)	
713 024N...065N	4-Insulated slotted screwdriver 2.5(75mmL); 3.5(100mmL); 5.5(125mmL) ; 6.5(150mmL)	
88401	1-Screwdriver probe voltage tester Testing range:110~250V AC	



## T20718-3

### 7pc Insulated screwdriver set



Part no.	10/6.8/7.8/1.1'	683g
711 1N...2N	Content: 2-Insulated Phillips screwdriver PH.1(80mmL); PH.2(100mmL)	
713 024N...065N	4-Insulated slotted screwdriver 2.5(75mmL); 3.5(100mmL); 5.5(125mmL) ; 6.5(150mmL)	
88403	1-Screwdriver probe voltage tester Testing range: 80~250V AC	



## T2084B

### 8pc Screwdriver set



Part no.	10/9.4/10.4/0.95'	935g
71303B	Content: 6-Anti-Slip Slotted Screwdriver 3mm(75mmL)	
713035B	3.5mm(100mmL)	
71304B	4mm(100mmL)	
713055B	5.5mm(125mmL)	
713065B	6.5mm(150mmL)	
71308B	8mm(175mmL)	
7111B	2-Anti-Slip Phillips Screwdriver PH.1(80mmL)	
7112B	PH.2(100mmL)	

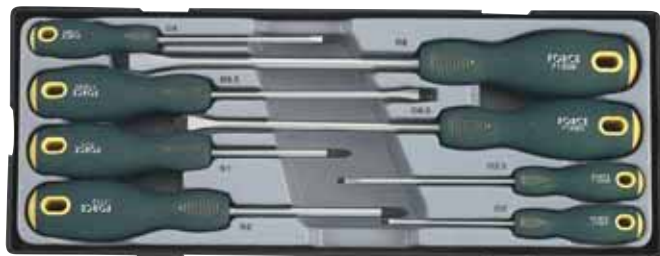

## T2084YC

### 8pc Screwdriver set



Part no.	10/8.2/9.2/0.95'	815g
Content:		
6-Anti-Slip Slotted Screwdriver		
71303	3mm(75mmL)	
713035	3.5mm(100mmL)	
71304	4mm(100mmL)	
713055	5.5mm(125mmL)	
713065	6.5mm(150mmL)	
71308	8mm(175mmL)	
2-Anti-Slip Phillips Screwdriver		
7111	PH.1(80mmL)	
7112	PH.2(100mmL)	

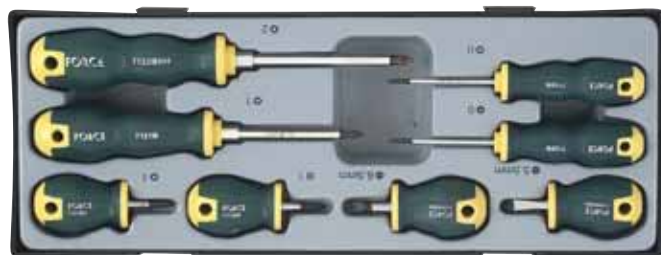

## T2085B

### 8pc Screwdriver set



Part no.	10/4.6/5.6/0.95'	750g
Content:		
2-Anti-Slip Slotted Screwdriver		
713055BS	5.5mm(25mmL)	
713065BS	6.5mm(25mmL)	
2-Anti-Slip Phillips Screwdriver		
7110B	PH.0(60mmL)	
7111BS	PH.1(25mmL)	
4-Anti-Slip Pozidriv Screwdriver		
7120B	PZ.0(60mmL)	
7121BS	PZ.1(25mmL)	
7121B	PZ.1(80mmL)	
7122B	PZ.2(100mmL)	



## T2085YC

### 8pc Screwdriver set



Part no.	10/6.2/7.2/0.95'	620g
Content:		
2-Anti-Slip Slotted Screwdriver		
713055S	5.5mm(38mmL)	
713065S	6.5mm(38mmL)	
2-Anti-Slip Phillips Screwdriver		
7110	PH.0(60mmL)	
7111S	PH.1(38mmL)	
4-Anti-Slip Pozidriv Screwdriver		
7120	PZ.0(60mmL)	
7121S	PZ.1(38mmL)	
7121	PZ.1(80mmL)	
7122	PZ.2(100mmL)	



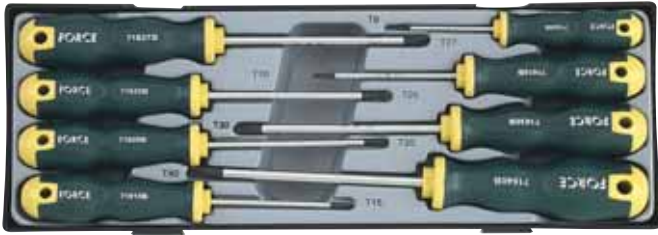

**T2086B**

**8pc Star Screwdriver set**

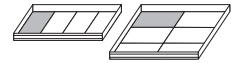

Part no.	10/8.4/9.4/0.95'	840g
716 08B.. 40B	Content: 8-Star screwdriver T8;T10;T15;T20;T25;T27; T30;T40	

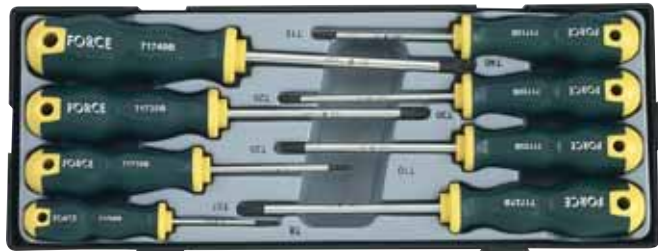

**T2086TB**

**8pc Star temperproof Screwdriver set**



Part no.	10/8.4/9.4/0.95'	840g
717 08B.. 40B	Content: 8-Star temperproof screwdriver T-8H;T-10H;T-15H;T-20H;T-25H; T-27H;T-30H;T-40H	

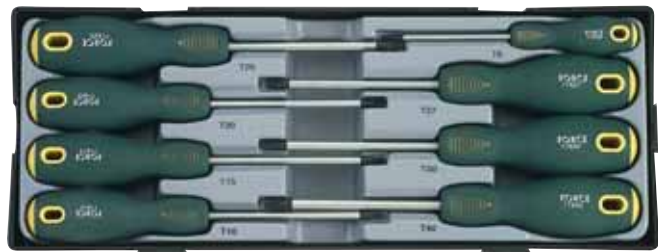

**T2086YC**

**8pc Star Screwdriver set**

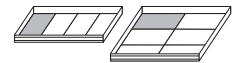

Part no.	10/8.5/9.5/0.95'	845g
716 08...40	Content: 8-Star screwdriver T8;T10;T15;T20;T25; T27;T30;T40	



**T20810**

**8pc Hex Screwdriver set**



Part no.	10/8.2/9.2/0.95'	820g
714 02B.. 10B	Content: 8-Hex anti-slip screwdriver 2;2.5;3;4;5;6;8;10mm	



**T20810B**

**8pc Hex ball point Screwdriver set**



Part no.	10/8.2/9.2/0.95'	820g
715 02B.. 10B	Content: 8-Hex ball point screwdriver 2;2.5;3;4;5;6;8;10mm	



## T2173

### Jeweler screwdriver & (de-)magnetizer set



Part no.	6/3.5/4.5/0.9'	590g
731040 000...00	Content: 2-Phillips jeweler screwdriver PH.000; PH.00 (40mmL)	
733040 01...024	6-Slotted jeweler screwdriver 1.0; 1.2; 1.5; 1.8; 2.0; 2.4 mm(40mmL)	
734040 009...015	3-Hex jeweler screwdriver 0.9; 1.3; 1.5 mm(40mmL)	
736040 05...08	4-Star jeweler screwdriver T5; T6; T7; T8 (40mmL)	
2161-1	1-Tweezer	
88601	1-Demagnetizer/Magnetizer	



## T2641

### 65pc Socket Combination set



Part no.	6/15.0/16.0/0.9'	2500g
525 032...14	Content: 1/4"DR. 14-6pt. Flank socket 3.2;4;4.5;5;5.5;6;7;8;9;10;11;12; 13;14mm	
52550 05...13	9-6pt. Flank deep socket 5;6;7;8;9;10;11;12;13mm 24-Socket bit(32mmL)	
32432 03...10	Hex 3;4;5;6;7;8;10mm	
32132 1...3	Phillips PH.1;PH.2;PH.3	
32232 1...3	Pozidriv PZ.1;PZ.2;PZ.3	
32332 04...065	Slotted 4;5.5;6.5mm	
32632 08...40	Star T8;T10;T15;T20;T25;T27; T30;T40	
802222	1-72 teeth Ratchet handle	
8042 050...150	3-Extension 2" & 4"&6"	
8032115	1-Sliding T handle	
80521	1-Universal joint	
8143	1-Spinner 6"	
81225	1-Magnetic socket pick-up	
5102XLB	10-Hex ball point key(Long pattern) 1.27;1.5;2;2.5;3;4;5;6;8;10mm	



## T2641-15

### 65pc Socket Combination set



Part no.	6/15.0/16.0/0.9'	2500g
	Content: 1/4"DR.	
525 032...14	14-6pt. Flank socket 3.2;4;4.5;5;5.5;6;7;8;9;10;11;12; 13;14mm	
52550 05...13	9-6pt. Flank deep socket 5;6;7;8;9;10;11;12;13mm	
	24-Socket bit(32mmL)	
32432 03...10	Hex 3;4;5;6;7;8;10mm	
32132 1...3	Phillips PH.1;PH.2;PH.3	
32232 1...3	Pozidriv PZ.1;PZ.2;PZ.3	
32332 04...065	Slotted 4;5.5;6.5mm	
32632 08...40	Star T8;T10;T15;T20;T25;T27; T30;T40	
802215	1-Ratchet handle-20 teeth	
8042 050...150	3-Extension 2" & 4" & 6"	
8032115	1-Sliding T handle	
80521	1-Universal joint	
8143	1-Spinner 6"	
81225	1-Magnetic socket pick-up	
5102XLB	10-Hex ball point key(Long pattern) 1.27;1.5;2;2.5;3;4;5;6;8;10mm	



## T2741

### 74pc Socket Combination set(MM & SAE)



Part no.	6/11.0/12.0/0.9'	1840g
	Content: 1/4"DR.	
525 04...13	18-6pt. Flank socket 4;4.5;5;5.5;6;7;8;9;10;11;12;13mm	
525 3.16...1.2	3/16";1/4";9/32";11/32";3/8";1/2"	
	18-6pt. Flank deep socket	
52550 04...13	4;4.5;5;5.5;6;7;8;9;10;11;12;13mm	
52550 3.16...1.2	3/16";1/4";9/32";11/32";3/8";1/2"	
	30-Socket bit (32mmL)	
32432 03...10	Hex 3;4;5;6;7;8;10mm	
32432 1.8...3.8	Hex 1/8";3/16";7/32";1/4";3/8"	
32132 1...3	Phillips PH.1; PH.2; PH.3	
32232 1...3	Pozidriv PZ.1;PZ.2;PZ.3	
32332 03...065	Slotted 3;4;5.5;6.5mm	
32632 08...40	Star T8;T10;T15;T20;T25;T27;T30;T40	
802215	1-Ratchet handle	
8042 050...150	3-Extension 2" & 4" & 6"	
8032115	1-Sliding T handle	
80521	1-Universal Joint	
8143	1-Spinner 6"	
81225	1-Magnetic socket pick-up	



## T2742

### 74pc Socket Combination set



Part no.	6/9.5/10.5/0.9'	1580g
	Content: 1/4" DR.	
525 04...13	12-6pt. Flank socket 4;4.5;5;5.5;6;7;8;9;10;11;12;13mm	
52550 04...13	12-6pt. Flank deep socket 4;4.5;5;5.5;6;7;8;9;10;11;12;13mm	
526 04....10	6-Star socket E4;E5;E6;E7;E8;E10	
52650 04...10	6-Star deep socket E4;E5;E6;E7;E8;E10	
	32-Socket bit(32mmL)	
32432 03...10	Hex 3;4;5;6;7;8;10mm	
32132 0...2	Phillips PH.0;PH.1;PH.2	
32232 0...2	Pozidriv PZ.0;PZ.1;PZ.2	
32332 04...065	Slotted 4;5.5;6.5mm	
32632 08...40	Star T8;T10;T15;T20;T25;T27;T30;T40	
32732 08...40	Star tamper T-8H;T-10H;T-15H;T-20H; T-25H;T-27H;T-30H;T-40H	
802220	1-72 teeth T mini ratchet	
8042 050...150	3-Extension 2" & 4" & 6"	
80521	1-Universal joint	
81225	1-Magnetic socket pick-up	



## T2742-15

### 74pc Socket Combination set



Part no.	6/9.5/10.5/0.9'	1580g
	Content: 1/4" DR.	
525 04...13	12-6pt. Flank socket 4;4.5;5;5.5;6;7;8;9;10;11;12;13mm	
52550 04...13	12-6pt. Flank deep socket 4;4.5;5;5.5;6;7;8;9;10;11;12;13mm	
526 04...10	6-Star socket E4;E5;E6;E7;E8;E10	
52650 04...10	6-Star deep socket E4;E5;E6;E7;E8;E10	
	32-Socket bit(32mmL)	
32432 03...10	Hex 3;4;5;6;7;8;10mm	
32132 0...2	Phillips PH.0;PH.1;PH.2	
32232 0...2	Pozidriv PZ.0;PZ.1;PZ.2	
32332 04...065	Slotted 4;5.5;6.5mm	
32632 08...40	Star T8;T10;T15;T20;T25;T27;T30;T40	
32732 08...40	Star tamper T-8H;T-10H;T-15H;T-20H; T-25H;T-27H;T-30H;T-40H	
802215	1-20 teeth Ratchet handle	
8042 050...150	3-Extension 2" & 4" & 6"	
80521	1-Universal joint	
81225	1-Magnetic socket pick-up	



## T2742-18



### 74pc Socket Combination set

Part no.	6/9.5/10.5/0.9'	1580g
	Content: 1/4"DR.	
525 04...13	12-6pt.Flank socket 4;4.5;5;5.5;6;7;8;9;10;11;12;13mm	
52550 04...13	12-6pt.Flank deep socket 4;4.5;5;5.5;6;7;8;9;10;11;12;13mm	
526 04...10	6-Star socket E4;E5;E6;E7;E8;E10	
52650 04...10	6-Star deep socket E4;E5;E6;E7;E8;E10	
	32-Socket bit(32mmL)	
32432 03...10	Hex 3;4;5;6;7;8;10mm	
32132 0...2	Phillips PH.0;PH.1;PH.2	
32232 0...2	Pozidriv PZ.0;PZ.1;PZ.2	
32332 04...065	Slotted 4;5.5;6.5mm	
32632 08...40	Star T8;T10;T15;T20;T25;T27;T30;T40	
32732 08...40	Star tamper T-8H;T-10H;T-15H;T-20H; T-25H;T-27H;T-30H;T-40H	
802218	1-20 teeth Flexible ratchet handle	
8042 050...150	3-Extension 2" & 4" & 6"	
80521	1-Universal joint	
81225	1-Magnetic socket pick-up	



## T30711



### 7pc Ratchet handle set

Part no.	6/14.1/15.1/0.8'	2350g
	Content: 3/8"DR.	
6473365	1-Torque wrench	
802318	1-30 teeth Flexible ratchet handle	
802315	1-30 teeth Ratchet handle	
802319	1-30 teeth Stubby ratchet handle	
8073 16M...	3-Magnetic spark plug socket	
20.6M	16;18;20.6mm	



## T30712



### 7pc Ratchet handle set

Part no.	6/14.7/15.7/0.9'	2440g
	Content: 3/8"DR.	
6473365	1-Torque wrench	
802323	1-72 teeth Flexible ratchet handle	
80232	1-24 teeth Ratchet handle	
802319	1-30 teeth Stubby ratchet handle	
8073 16...	3-Spark plug socket	
20.6	16;18;20.6mm	



**T3121**

**12pc 6pt. Flank deep socket set**



Part no.	6/14.7/15.7/0.9'	2440g
53563 08 ...22	Content: 3/8"DR. 12-6pt. Flank deep socket 8;10;11;12;13;14;15;16;17;18; 19;22mm	



**T3193**

**19pc 6pt. Flank socket set(SAE)**



Part no.	6/10.6/11.6/0.9'	1760g
535 1.4... 7.8	Content: 3/8"DR. 11-6pt. Flank socket 1/4";5/16";3/8";7/16";1/2";9/16"; 5/8";11/16";3/4";13/16";7/8"	
53563 5.16 ..3.4	8-6pt. Flank deep socket 5/16";3/8";7/16";1/2";9/16";5/8"; 11/16";3/4"	



**T3212**

**21pc Socket set(SAE)**



Part no.	6/12.2/13.2/0.9'	2040g
535 1.4...7.8	Content:3/8"DR. 13-6pt. Flank socket 1/4";5/16";3/8";7/16";1/2";9/16"; 19/32";5/8";11/16";3/4";25/32"; 13/16";7/8"	
80232	1-24 teeth Ratchet handle	
8033165	1-Sliding T handle	
8043 075...250	3-Extension 3"&6"&10"	
80531	1-Universal joint	
8073 16..20.6	2-Spark plug socket 16&20.6mm	



**T3224**

**22pc Universal Socket set**



Part no.	6/17.2/18.2/0.9'	2860g
80535 10...19	Content:3/8"DR. 10-Universal socket (42mmL) 10;11;12;13;14;15;16;17;18;19mm	
8053585 10.. 19	10-Universal deep socket (85mmL) 10;11;12;13;14;15;16;17;18;19mm	
8073 16UM... 20.6UM	2-Universal magnetic spark plug 16;20.6mm	



**T3251-5**  
24pc Socket set



Part no.	6/12.0/13.0/0.9'	1990g
535 06...22	Content:3/8"DR. 17-6pt. Flank socket 6;7;8;9;10;11;12;13;14;15;16;17; 18;19;20;21;22mm	
80232	1-24 teeth Ratchet handle	
8043 075...150	2-Extension 3"&6"	
80531	1-Universal joint	
8033165	1-Sliding T handle	
8073 16...20.6	2-Spark plug socket 16mm&20.6mm	



**T3251-5-18**  
24pc Socket set



Part no.	6/15.0/16.0/0.9'	2500g
535 06...22	Content:3/8"DR. 17-6pt. Flank socket 6;7;8;9;10;11;12;13;14;15;16;17;18; 19;20;21;22mm	
802318	1-30 teeth Flexible ratchet handle	
8043 075...150	2-Extension 3"&6"	
80531	1-Universal joint	
8033165	1-Sliding T handle	
8073 16...20.6	2-Spark plug socket 16mm&20.6mm	



**T3251-5-15**  
24pc Socket set



Part no.	6/15.0/16.0/0.9'	2500g
535 06...22	Content:3/8"DR. 17-6pt. Flank socket 6;7;8;9;10;11;12;13;14;15;16;17; 18;19;20;21;22mm	
802315	1-Ratchet handle – 30 teeth	
8043 075...150	2-Extension 3"&6"	
80531	1-Universal joint	
8033165	1-Sliding T handle	
8073 16...20.6	2-Spark plug socket 16mm&20.6mm	



**T3251-72-5**  
24pc Socket set



Part no.	6/11.1/12.1/0.9'	1850g
535 06...22	Content:3/8"DR. 17-6pt. Flank socket 6;7;8;9;10;11;12;13;14;15;16; 17;18;19;20;21;22mm	
802322	1-72 teeth Ratchet handle	
8043 075...150	2-Extension 3"&6"	
80531	1-Universal joint	
8033165	1-Sliding T handle	
8073 16...20.6	2-Spark plug socket 16mm&20.6mm	

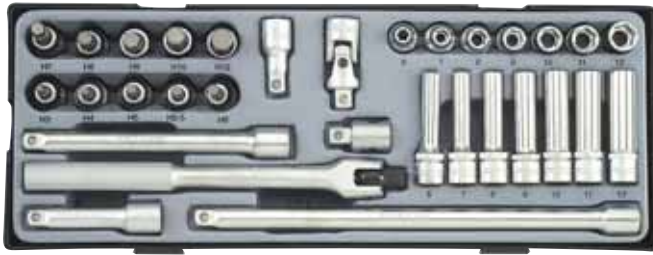

**T3311**

**31pc Socket combination set**

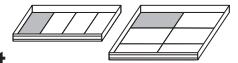

Part no.	6/14.5/15.5/0.9'	2400g
535 06...12	Content:3/8"DR. 7-6pt. Flank socket 6;7;8;9;10;11;12mm	
53563 06...12	7-6pt. Flank deep socket 6;7;8;9;10;11;12mm	
334050 03...12	10-Hex socket bit(50mmL) 3;4;5;5.5;6;7;8;9;10;12mm	
8013215	1-Swivel handle	
8043 044...250	4-Extension 1.75";3";6";10"	
80531	1-Universal joint	
80633	1-Adaptor for extension 3/8"(F) x 3/8"(M)	



**T3322**

**32pc Socket set(MM & SAE)**



Part no.	6/15/16/0.9'	2500g
535 06...22	Content:3/8"DR. 17-6pt. Flank socket(MM) 6;7;8;9;10;11;12;13;14;15;16;17; 18;19;20;21;22mm	
535 1.4...13.16	7-6pt. Flank socket(SAE) 1/4";3/8";1/2";9/16";5/8";11/16";13/16"	
8043 075...225	3-Extension 75-3";150-6";225-9"	
80643	1-Adaptor for extension 1/2"(F) x 3/8"(M)	
80531	1-Universal joint	
802322	1-72 teeth Ratchet handle	
8073 16...20.6	2-Spark plug socket 16mm; 20.6mm	



**T3322-15**

**32pc Socket set(MM & SAE)**



Part no.	6/15/16/0.9'	2500g
535 06...22	Content:3/8"DR. 17-6pt. Flank socket(MM) 6;7;8;9;10;11;12;13;14;15;16;17; 18;19;20;21;22mm	
535 1.4...13.16	7-6pt. Flank socket(SAE) 1/4";3/8";1/2";9/16";5/8";11/16";13/16"	
8043 075...225	3-Extension 75-3";150-6";225-9"	
80643	1-Adaptor for extension 1/2"(F) x 3/8"(M)	
80531	1-Universal joint	
802315	1-30 teeth Ratchet handle	
8073 16...20.6	2-Spark plug socket 16mm; 20.6mm	





### T3322-23

#### 32pc Socket set(MM & SAE)



Part no.	6/15/16/0.9'	2500g
	Content:3/8"DR.	
535 06...22	17-6pt. Flank socket(MM) 6;7;8;9;10;11;12;13;14;15;16;17; 18;19;20;21;22mm	
535 1.4...13.16	7-6pt. Flank socket(SAE) 1/4";3/8";1/2";9/16";5/8";11/16";13/16"	
8043 075...225	3-Extension 75-3";150-6";225-9"	
80643	1-Adaptor for extension 1/2"(F) x 3/8"(M)	
80531	1-Universal joint	
802323	1-72 teeth Flexible ratchet handle	
8073 16...20.6	2-Spark plug socket 16mm; 20.6mm	



### T3322-24

#### 32pc Socket set(MM & SAE)



Part no.	6/15/16/0.9'	2500g
	Content:3/8"DR.	
535 06...22	17-6pt. Flank socket(MM) 6;7;8;9;10;11;12;13;14;15;16;17; 18;19;20;21;22mm	
535 1.4...13.16	7-6pt. Flank socket(SAE) 1/4";3/8";1/2";9/16";5/8";11/16";13/16"	
8043 075...225	3-Extension 75-3";150-6";225-9"	
80643	1-Adaptor for extension 1/2"(F) x 3/8"(M)	
80531	1-Universal joint	
80232	1-24 teeth Ratchet handle	
8073 16...20.6	2-Spark plug socket 16mm; 20.6mm	



### T3331

#### 33pc 6pt. Flank & star socket set



Part no.	6/14.5/15.5/0.9'	2430g
	Content:3/8"DR.	
535 13...24	11-6pt. Flank socket 13;14;15;16;17;18;19;20;21;22;24mm	
53563 13...22	10-6pt. Flank deep socket 13;14;15;16;17;18;19;20;21;22mm	
33650 08...60	12-Srar socket bit(50mmL) T8;T10;T15;T20;T25;T27;T30;T40; T45;T50;T55;T60	



**T3361**

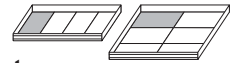

**36pc Socket Combination set**

Part no.	6/20.5/21.5/0.9'	3410g
535 06...22	Content:3/8"DR. 17-6pt. Flank socket 6;7;8;9;10;11;12;13;14;15;16;17; 18;19;20;21;22mm	
802322	1-72 teeth Ratchet handle	
8043 075...225	3-Extension 3"&6"&9"	
8073 16...20.6	2-Spark plug socket 16&20.6mm	
80531	1-Universal joint	
80643	1-Adaptor for extension 1/2"(F) x 3/8"(M)	
755 07...17	11-Combination wrench 7;8;9;10;11;12;13;14;15;16;17mm	

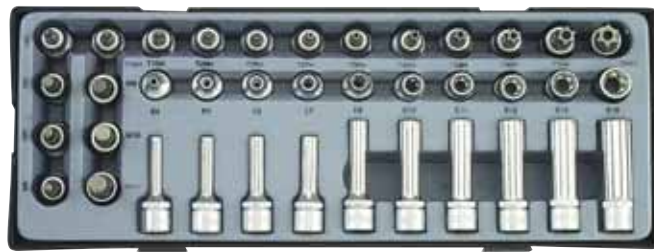

**T3381**



**38pc Star & Spline set**

Part no.	6/11.0/12.0/0.9'	1790g
536 04...16	Content:3/8"DR. 10-Star socket E4;E5;E6;E7;E8;E10;E11;E12; E14;E16	
53655 04...07	10-Star deep socket E4;E5;E6;E7;(55mmL)	
53663 08...16	E8;E10;E11;E12;E14;E16(63mmL)	
33750 08...60	12-Star tamper socket bit(50mmL) T-8H;T-10H;T-15H;T-20H;T-25H;T-27H; T-30H;T-40H;T-45H;T-50H;T-55H;T-60H	
33850 05...12	6-Spline socket bit(50mmL) M5;M6;M8;M9;M10;M12	

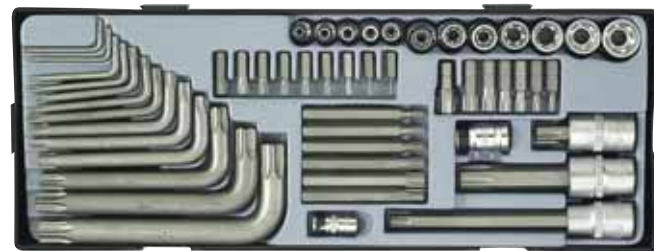

**T3521**



**52pc Star set**

Part no.	6/18.0/19.0/0.9'	3000g
15630 20...55	Content: 13-5/16" Star bit T20;T25;T30;T40;T45;T50;T55(30mmL)	
15670 20...50	T20;T25;T30;T40;T45;T50(70mmL)	
526 04...08	5-1/4"DR Star socket E4;E5;E6;E7;E8	
536 10...20	7-3/8"DR Star socket E10;E11;E12;E14;E16;E18;E20	
766 09...70	13-Star L key T9;T10;T15;T20;T25;T27;T30;T40;T45; T50;T55;T60;T70	
12725 08...40	9-1/4" Star tamperproof bit T-8H;T-10H;T-15H;T-20H;T-25H;T-27H; T-30H;T-35H;T-40H(25mmL)	
34614055	3-Star socket bit T55(140mmL);	
34605560	T60(55mmL);	
34610070	T70(100mmL)	
810 22...35	2-Bit holder 1/4"DR.x1/4";3/8"DR.x5/16"	



**T4057**

**5pc Accessory set**



Part no.	6/15.0/16.0/0.9'	2500g
802422	Content: 1/2"DR. 1-72 teeth ratchet handle	
8044 125...250	2-Extension 5" & 10"	
8034250	1-Sliding T handle	
80541	1-Universal joint	



**T4057-15**

**5pc Accessory set**



Part no.	6/15.0/16.0/0.9'	2500g
802415	Content: 1/2"DR. 1-36 teeth ratchet handle	
8044 125...250	2-Extension 5" & 10"	
8034250	1-Sliding T handle	
80541	1-Universal joint	



**T40612**

**6pc Accessory set**



Part no.	6/15.5/17.5/0.9'	2750g
802415	Content: 1/2"DR. 1-36 teeth ratchet handle	
8044 125...250	2-Extension 5"; 10"	
8034250	1-Sliding T handle	
80541	1-Universal joint	
8014380	1-Swivel handle 15"	



**T40613**

**6pc Accessory set**



Part no.	6/16.5/17.5/0.9'	2750g
802418	Content: 1/2"DR. 1-36 teeth Flexible ratchet handle	
8044 125...250	2-Extension 5"; 10"	
8034250	1-Sliding T handle	
80541	1-Universal joint	
8014380	1-Swivel handle 15"	



**T40613-23**  
6pc Accessory set



Part no.	6/16.5/17.5/0.9'	2750g
802423	Content:	
8044 125...250	1-72 teeth Flexible ratchet handle	
8034250	2-Extension 5";10"	
80541	1-Sliding T handle	
8014380	1-Universal joint	
	1-Swivel handle 15"	

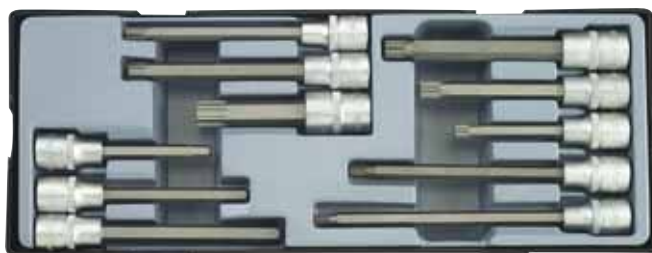

**T4116**  
11pc Mixed socket set



Part no.	6/13.5/14.5/0.9'	2250g
344 18005...	Content:	
14010	5-Hex socket bit	
	5mm(180mmL);6mm(160mmL);	
	7mm(100mmL);8mm(120mmL);	
	10mm(140mmL)	
	3-Star Socket bit	
346140 45...55	T45;T55(140mmL)	
34610070	T70(100mmL)	
	3-Spline socket bit	
34810008	M 8(100mmL)	
34812010	M10(120mmL)	
34814012	M12(140mmL)	



**T4119**  
11pc 6pt. Flank impact deep socket set



Part no.	6/23.3/24.3/0.9'	3890g
44585 12...32	Content: 1/2"DR.	
	11-6pt. Flank impact deep socket	
	12;14;17;19;21;22;23;24;27;	
	30;32mm(85mmL)	



**T4122**  
12pc Socket bit set



Part no.	6/13.0/14.0/0.9'	2160g
34418005	Content: 1/2"DR.	
344100 06...08	4-Hex socket bit	
	5mm(180mmL)	
	6;7;8mm(100mmL)	
	4-Star Socket bit	
346120 40...45	T40;T45(120mmL)	
346140 55...70	T55;T70(140mmL)	
	4-Spline socket bit	
348100 06...12	M6;M8;M10;M12(100mmL)	



**T4143**

**14pc 6pt. Flank deep socket set**



Part no.	6/18.6/19.6/0.9'	3100g
54577 10...32	Content: 1/2"DR. 14-6pt. Flank deep socket 10;12;13;14;15;17;19;21;22; 23;24;27;30;32mm(77mmL)	



**T4193**

**19pc 6pt. Flank impact socket set**



Part no.	6/18.8/19.8/0.9'	3130g
445 10...32	Content: 1/2"DR. 18-6pt. Flank impact socket 10;11;12;13;14;15;16;17;18; 19;21;22;23;24;26;27;30;32mm	
8044125MPB	1-Ball-type Impact extension (125mmL)	



**T4194**

**19pc 6pt. Flank socket set (SAE)**



Part no.	6/14.8/15.8/0.9'	2470g
545 5.16..1.1.4	Content: 1/2"DR. 19-6pt. Flank socket 5/16";3/8";7/16";15/32";1/2"; 9/16";19/32";5/8";11/16";3/4"; 25/32";13/16";7/8";15/16";1"; 1-1/16";1-1/8";1-3/16";1-1/4"	



**T4203**

**20pc 6pt. Flank socket set**



Part no.	6/24.5/25.5/0.9'	4080g
545 20...32	Content: 10-6pt. Flank socket 20;21;22;23;24;26;27;28;30;32mm	
54577 20...32	10-6pt. Flank deep socket 20;21;22;23;24;26;27;28;30;32mm	



**T4212**

**21pc 6pt. Flank socket set**



Part no.	6/16.0/17.0/0.9'	2666g
545 08...32	Content: 1/2"DR. 21-6pt. Flank socket 8;10;11;12;13;14;15;16;17;18;19;20; 21;22;23;24;26;27;28;30;32mm	

**T4214**

**21pc 12pt. Flank socket set**



Part no.	6/20.0/21.0/0.9'	3330g
545 08...26	Content: 1/2"DR. 15-6pt. Flank socket 8;10;11;12;13;14;15;16;17;18; 19;21;22;23;26mm	
802422	1-72 teeth ratchet handle	
8044 125...250	2-Extension 5" & 10"	
80541	1-Universal joint	
80634	1-Adaptor for extension 3/8"(F) x 1/2"(M)	
807420.6	1-Spark plug socket 20.6mm	

**T4214-9**

Part no.	6/20.0/21.0/0.9'	3330g
Changed Items 549 08...26	Content: 1/2"DR. 15- 12pt. Flank socket 8; 10; 11; 12; 13; 14; 15; 16; 17; 18; 19; 21; 22; 23; 26 mm	



**T4248**

**24pc 6pt. Flank socket set**

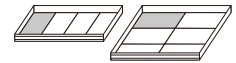

Part no.	6/13.0/14.0/0.9'	2160g
545 08...19	Content: 12-6pt. Flank deep socket 8;9;10;11;12;13;14;15;16;17;18;19mm	
54577 08...19	12-6pt. Flank deep socket 8;9;10;11;12;13;14;15;16;17;18;19;mm	



**T4248S**

**24pc 6pt. Flank socket set(SAE)**



Part no.	6/13.0/14.0/0.9'	2160g
545 3.8..1.1.16	Content: 1/2"DR. 12-6pt. Flank socket 3/8";7/16";1/2";9/16";5/8";11/16";3/4"; 13/16";7/8";15/16";1";1-1/16"	
54577 3.8... 1.1.16	12-6pt. Flank deep socket 3/8";7/16";1/2";9/16";5/8";11/16";3/4"; 13/16";7/8";15/16";1";1-1/16"	



**T4281**

**27pc Socket bit set**



Part no.	6/21.0/22.0/0.9'	3500g
344055 04...12	Content: 3/8" & 1/2"DR. 11-1/2"DR. Hex socket bit	
34406014	4;5;6;7;8;10;12mm(55mmL)	
34407017	14mm(60mmL)	
34408008	17mm(70mmL)	
34414010	8mm(80mmL) 10mm(140mmL)	
348055 05...16	10-1/2"DR. Spline socket bit	
348110 10...12	M5;M6;M8;M10;M12;M14;M16(55mmL)	
34812005	M10;M12(110mmL) M8(120mmL)	
334050 04...10	6-3/8"DR. Hex socket bit 4;5;6;7;8;10(50mmL)	



## T4322

### 32pc 1/2" Star & Spline set



Part no.	6/21.0/22.0/0.9'	3180g
546 10...24	Content: 1/2"DR. 8-Star socket E10;E11;E12;E14;E16;E18;E20;E24	
54677 10...24	8-Star deep socket E10;E11;E12;E14;E16;E18;E20;E24	
346055 50...70	4-Star socket bit(55mmL) T50;T55;T60;T70	
347055 50...70	4-Star tamper socket bit(55mmL) T-50H;T-55H;T-60H;T-70H	
348055 05...16	8-Spline socket bit(55mmL) M5;M6;M8;M9;M10;M12;M14;M16	



## T4411

### 41pc Star set



Part no.	6/14.8/15.0/0.9'	2466g
766 09...70	Content: 1/4" & 3/8" & 1/2"DR. 13-Star L key T9;T10;T15;T20;T25;T27;T30; T40;T45;T50;T55;T60;T70	
12630 09...20	4-1/4" Star bit(30mmL) T9;T10;T15;T20	
17630 25...50	6-10mm Star bit(30mmL) T25;T27;T30;T40;T45;T50	
17611555	1-10mm Star bit T55(115mmL)	
19675 60...70	2-14mm Star bit (75mmL) T60;T70	
526 04...08	5-1/4"DR.Star socket E4;E5;E6;E7;E8	
536 10...20	7-3/8"DR. Star socket E10;E11;E12;E14;E16;E18;E20	
810 22...414	3-Bit holder 1/4"DR.x1/4";3/8"DRx10mm; 1/2"DR.x14mm	





**T4413**  
41pc Star set



Part no.	6/13.0/14.0/0.9'	2170g
5071	Content: 1/4" & 3/8" & 1/2"DR. 12-Star key	
766 10...70	5071:T10;T15;T20;T25;T27;T30; T40;T45;T50;T55;T60;T70	
32632 08...40	9-1/4" Star socket bit(32mmL) T8;T9;T10;T15;T20;T25;T27;T30;T40	
33650 45...50	2-3/8" Star socket bit T45;T50(50mmL)	
34614055	3-1/2" Star socket bit T55(140mmL)	
34610060	T60(100mmL)	
34610070	T70(100mmL)	
526 04...10	15-Torx socket 1/4"DR.-E4;E5;E6;E7;E8;E10	
536 10...20	3/8"DR.-E10;E11;E12;E14;E16;E18;E20	
546 22...24	1/2"DR.-E22;E24	



**T5021**  
2pc Pliers set



Part no.	6/10.5/11.5/0.9'	1750g
613250	Content: 1-Waterpump plier 10"	
614250	1-Locking plier 10"	



**T5023**  
2pc Adjustable wrench set



Part no.	6/10.2/11.2/0.9'	1700g
649200B	Content: 2-Adjustable gauged wrench 8"(200mmL)	
649300B	12"(300mmL)	



**T5033**  
3pc Hinged socket wrench set



Part no.	6/15.0/16.0/0.9'	2500g
752 2022...	Content: 3-Hinged socket wrench	
2427	20x22;21x23;24x27mm	



**T5034**

**3pc Pliers set**

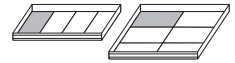

Part no.	6/10.0/11.0/0.9'	1060g
Content:		
610200	1-Long Nose pliers 8"	
611215	1-Combination pliers 8.5"	
612175	1-Diagonal pliers 7"	



**T5036**

**3pc Adjustable wrench set**

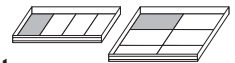

Part no.	6/13.3/14.3/0.9'	2210g
Content:		
3-Adjustable gauged wrench		
649200	8"(200mmL)	
649250	10"(250mmL)	
649300	12"(300mmL)	

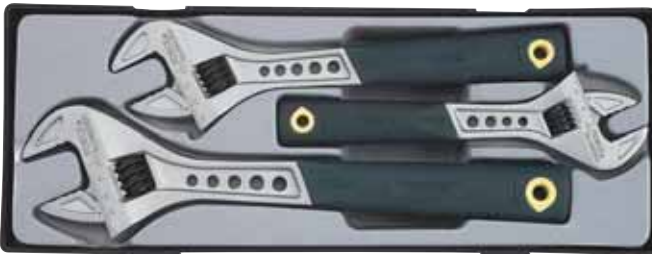

**T5036A**

**3pc Adjustable wrench set**



Part no.	6/12.2/13.2/0.9'	2040g
Content:		
3-Adjustable gauged wrench		
649200A	8"(200mmL)	
649250A	10"(250mmL)	
649300A	12"(300mmL)	



**T5038**

**3pc Pliers set**



Part no.	6/12.2/13.2/0.9'	2130g
Content:		
649250B	1-Adjustable wrench 10"	
613B250	1-Waterpump pliers 10"	
614250	1-Locking pliers 10"	

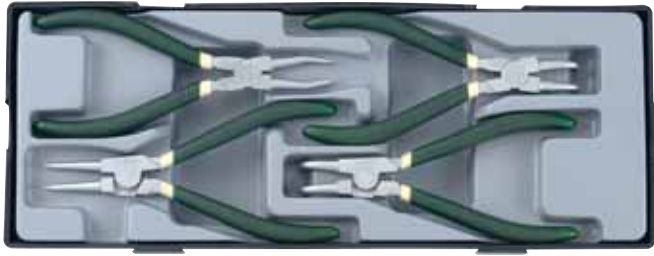

### T5043A

#### 4pc Snap ring pliers set



Part no.	6/10.8/11.8/0.9'	1800g
	Content:	
	4-Snap ring pliers	
609ASO	External straight tip 1.8mm(open)	
609ASC	Internal straight tip 1.8mm(close)	
609ABO	External 90°Bent tip 1.8mm(open)	
609ABC	Internal 90°Bent tip 1.8mm(close)	



### T5044

#### 4pc 75°Offset ring wrench set

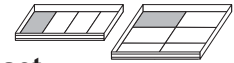

Part no.	6/13.7/14.7/0.9'	2280g
	Content:	
	4-75°Offset ring wrench	
759 2326...	23x26;24x27;25x28;30x32mm	
3032		

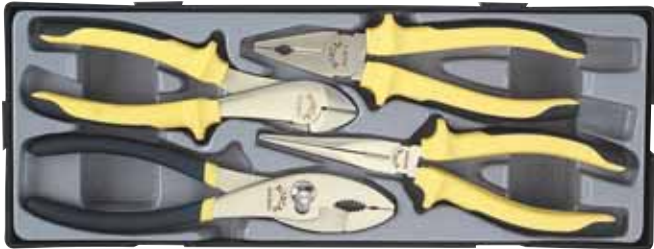

### T5045

#### 4pc Pliers set



Part no.	6/9.9/10.9/0.9'	1650g
	Content:	
610B200	1-Long nose pliers 8"	
611B175	1-Combination pliers 7"	
612B175	1-Diagonal pliers 7"	
673B215	1-Slip joint pliers 8"	

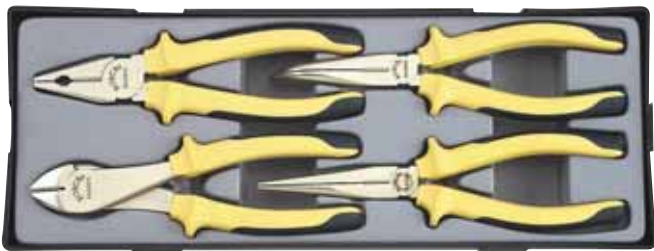

### T5046

#### 4pc Pliers set



Part no.	6/9.9/10.9/0.9'	1650g
	Content: 1/4"DR.	
610B200	1-Long nose pliers 8"	
610B200B	1-Bent long nose pliers 8"	
611B175	1-Combination pliers 7"	
612B175	1-Diagonal pliers 7"	

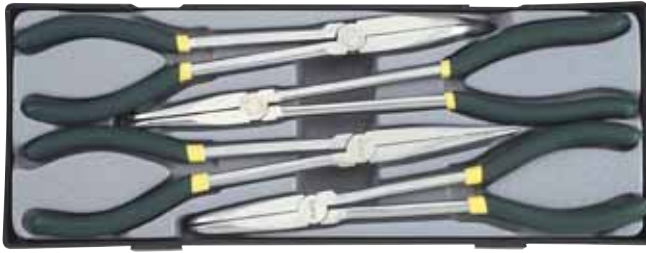

**T5047**  
4pc Pliers set



Part no.	6/11.8/12.8/0.9'	1970g
Content:		
5047P1	1-Long nose straight pliers 11"	
5047P2	1-Long nose 45° pliers 11"	
5047P3	1-Long nose 90° pliers 11"	
5047P4	1-Multi-purpose 4 points gripping pliers 11"	



**T50410**  
4pc Insulated pliers set

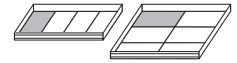

Part no.	6/6.5/7.5/0.9'	1080g
Content:		
6903180	1-Insulated combination pliers 7"	
6904160	1-Insulated long nose pliers 6"	
6911200	1-Insulated diagonal pliers 8"	
6912160	1-Insulated wire stripper pliers 6"	



**T5052**  
5pc Combination wrench set



Part no.	6/15.6/16.6/0.83'	2600g
Content:		
755 26...32	5-Combination wrench 26;27;28;30;32mm	



**T5053**  
5pc Hammer chisel set



Part no.	6/14.5/16.5/0.9'	2415g
Content:		
616300	1-Engineer hammer 300g	
616400	1-Rubber hammer 400g(280mmL)	
3-Chisel		
60215180	15mm(180mmL)	
60219200	19mm(200mmL)	
60225220	25mm(220mmL)	



### T5053A

#### 5pc Hammer chisel set

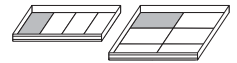

Part no.	6/13.4/14.4/0.9'	2232g
616300	1-Engineer hammer 300g	
616A400	1-Soft face hammer 400gw	
	3-Chisel	
60215180	15mm(180mmL)	
60219200	19mm(200mmL)	
60225220	25mm(220mmL)	



### T5053F

#### 5pc Hammer chisel set



Part no.	6/13.4/14.4/0.9'	2232g
616F032	1-Riveting hammer 32mm	
616400	1-Rubber hammer 400g (280mmL)	
	3-Chisel	
60215180	15mm(180mmL)	
60219200	19mm(200mmL)	
60225220	25mm(220mmL)	



### T5053AF

#### 5pc Hammer chisel set

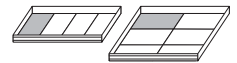

Part no.	6/13.4/14.4/0.9'	2232g
616F032	1-Riveting hammer 32mm	
616A400	1-Soft face hammer 400gw	
	3-Chisel	
60215180	15mm(180mmL)	
60219200	19mm(200mmL)	
60225220	25mm(220mmL)	



### T5055

#### 5pc Cutting tools set



Part no.	6/10.3/11.3/0.9'	1715g
	Content:	
5055P1	1-Straight shears	
66302	1-Mini hacksaw frame 6"	
5055P3	2-Saw blade	
5055P4	1-Utility Knife(incl. 2pc blades)	



**T5056**

**5pc File set**

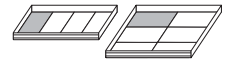

Part no.	6/10.2/11.2/0.9'	1690g
Content:		
5056P1	1-8" Flat file	
5056P2	1-8" Half round file	
5056P3	1-8" Round file	
5056P4	1-8" Square file	
5056P5	1-8" Triangular file	



**T5057**

**5pc Multi-grip pliers set**



Part no.	6/16.9/17.9/0.9'	2810g
Content:		
5-Self-locking multi-grip pliers		
67901	Wide flat jaw	
67902	Double curved jaw	
67903	Wide curved jaw	
67904	Angled jaw	
67905	Straight jaw	



**T50616S**

**6pc Hinged socket wrench set(SAE)**



Part no.	6/19.0/20.0/0.9'	3170g
Content:		
752 1011S...	6-Hinged socket wrench	
2425S	3/8"x7/16";1/2"x9/16";5/8"x11/16"; 3/4"x7/8";13/16"x7/8";15/16"x1"	



**T50617**

**6pc 15°Offset star ratchet ring wrench set**



Part no.	6/11.1/12.1/0.9'	1850g
Content:		
826 0607...	6-15°Offset star ratchet ring wrench	
2224	E6xE7;E8xE10;E11xE12; E14xE16;E18xE20;E22xE24	



### T50618-18



#### 6pc Spark plug combination set

Part no.	6/12.6/13.6/0.9'	2100g
647318P	Content: 3/8" DR. 1-Torque wrench 18Nm 245mmL (spark plug special torque set)	
8073250 16M... 20.6M	2-Magnetic spark plug socket 250mmL 16&20.6mm	
8073 16M... 20.6M	2-Magnetic spark plug socket 16&20.6mm	
5047P4	1-Multi-purpose 4 points gripping pliers 11"	



### T50618-24



#### 6pc Spark plug combination set

Part no.	6/12.6/13.6/0.9'	2100g
647324P	Content: 3/8" DR. 1-Torque wrench 24Nm 245mmL (spark plug special torque set)	
8073250 16M... 20.6M	2-Magnetic spark plug socket 250mmL 16&20.6mm	
8073 16M... 20.6M	2-Magnetic spark plug socket 16&20.6mm	
5047P4	1-Multi-purpose 4 points gripping pliers 11"	



### T5074



#### 7pc Hinged socket wrench set

Part no.	6/13.0/14.0/0.9'	2165g
752 0607... 1819	Content: 7-Hinged socket wrench 6x7;8x9;10x11;12x13;14x15;16x17; 18x19mm	



### T5075



#### 7pc Hinged star socket wrench set

Part no.	6/13.0/14.0/0.9'	2165g
756 0405F... 2224F	Content: 7-Star hinged socket wrench E4xE5;E6xE7;E8xE10;E11xE12; E14xE16;E18xE20;E22xE24	



**T5079S**



**7pc 75°Offset ring wrench set (SAE)**

Part no.	6/13.6/14.6/0.9'	2270g
759 0608S... 2425S	Content: 7-75°Offset ring wrench 1/4"x5/16";3/8"x7/16";1/2"x9/16"; 5/8"x11/16";3/4"x7/8";13/16"x7/8"; 15/16"x1"	



**T50710**



**7pc Flare nut wrench set(SAE)**

Part no.	6/10.0/11.0/0.9'	1670g
751 0810S... 1922S	Content: 7-Flare nut wrench 5/16"x3/8";3/8"x7/16";7/16"x1/2"; 1/2"x9/16";5/8"x3/4";11/16"x3/4";3/4"x7/8"	



**T5081**



**8pc 75°Offset ring wrench set (MM)**

Part no.	6/13.0/14.0/0.9'	2166g
759 0607... 2123	Content: 8-75°Offset ring wrench 6x7;8x9;10x11;12x13;14x15;16x17; 18x19;21x23mm	



**T5082**



**8pc Flare nut wrench set**

Part no.	6/15.3/16.3/0.9'	2550g
751 0810... 3032	Content: 8-Flare nut wrench 8x10;11x13;12x14;16x18;17x19; 19x22;24x27;30x32mm	



**T5085**



**8pc 45°Offset ring wrench set (MM)**

Part no.	6/10.3/11.3/0.9'	1720g
758 0809... 2224	Content: 8-45°Offset ring wrench 8x9;10x11;12x13;14x15;16x17; 18x19;21x23;22x24mm	





**T5085S**

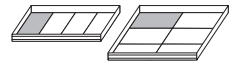

**8pc 45° Offset ring wrench set (SAE)**

Part no.	6/10.3/11.3/0.9'	1720g
758 0608S... 2224S	Content: 8-45° Offset ring wrench 1/4"x5/16";3/8"x7/16";7/16"x1/2";1/2"x9/16"; 5/8"x11/16";11/16"x3/4";13/16"x7/8";7/8"x15/16"	



**T5089**

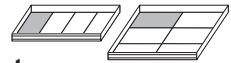

**8pc Combination wrench set**

Part no.	6/20.4/21.4/0.8'	3400g
755 24...32	Content: 8-Combination wrench 24;25;26;27;28;29;30;32mm	



**T50810**



**8pc Ratchet ring wrench set**

Part no.	6/13.0/14.0/0.9'	2160g
824 0607... 2122	Content: 8-Ratchet ring wrench 6x7;8x9;10x11;12x13;14x15;16x18; 17x19;21x22mm	

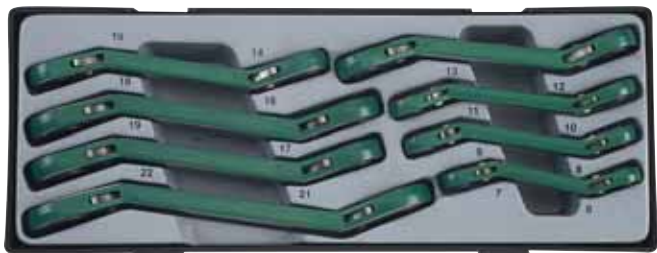

**T50811**



**8pc 15° Offset ratchet ring wrench set**

Part no.	6/13.1/14.1/0.9'	2180g
825 0607... 2122	Content: 8-15° Offset ratchet ring wrench 6x7;8x9;10x11;12x13;14x15;16x18; 17x19;21x22mm	



**T50812**



**8pc Flat gear wrench set (SAE)**

Part no.	6/10.8/11.8/0.9'	1800g
757 5.16... 3.4	Content: 8-Flat gear wrench 5/16";3/8";7/16";1/2";9/16";5/8"; 11/16";3/4"	



**T50813**

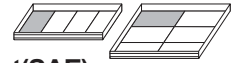

**8pc Reversible gear wrench set(SAE)**

Part no.	6/10.8/11.8/0.9'	1800g
757 5.16R... 3.4R	Content: 8-Reversible gear wrench 5/16";3/8";7/16";1/2";9/16";5/8"; 11/16";3/4"	

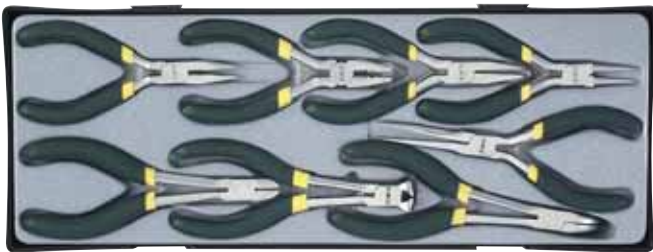

**T50814**

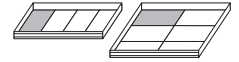

**8pc Mini pliers set**

Part no.	6/8.4/9.4/0.9'	1400g
50814P1 50814P2 50814P3 50814P4 50814P5 50814P6 50814P7 50814P8	Content: 1-Round nose pliers 5" 1-Flat nose pliers 5" 1-Combination pliers 5" 1-Long nose pliers 5" 1-Needle nose pliers 6" 1-Bent nose pliers 6" 1-Cutter pliers 6" 1-Diagonal pliers 6"	



**T50822**

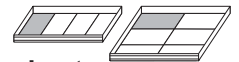

**8pc Hammer(500gw) & Chisel set**

Part no.	6/5.0/6.0/0.9'	836g
60212150 603150 6044190 6063185 6074185 616500 618 905M2P3	Content: 1-Chisel 12mm (150mmL) 1-Cape chisel 150mm 1- Pin punch 4mm (190mmL) 1-Taper punch 3mm (185mmL) 1-Center punch 4mm (185mmL) 1-Engineer hammer 500g 1-20pcs Feeler gauge set included 20 blades 0.05mm to 1.00mm. 1-Gasket scraper	



**T5096**

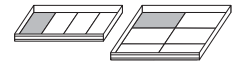

**9pc Measuring tools set**

Part no.	6/9.3/10.3/0.9'	1550g
5096P1 5096P2 5096P3 5096P4 5096P5 5096P6 61802 5096P7 5096P8	Content: 1-Stainless steel vernier caliper 1-Auto center punch 1-Stainless steel straight ruler 30cm 1-Stainless steel protractor 1-Screw pitch gauges 0.25-6(Metric) 1-Screw pitch gauges 4-62(SAE) 1-26 sizes Feeler gauges(SAE & Metric) 1-Steel scriber 1-5m measuring tape	



**T50918**



**9pc Ratchet Flare nut wrench**

Part no.	6/8.3/9.3/0.9'	1390g
751 08A...22A	Content: 8-Ratchet flare nut wrench 8; 10; 11; 12; 13; 14; 17; 19; 22 mm	



**T5111**



**11pc Double open end wrench set**

Part no.	6/16.0/17.0/0.9'	2666g
754 0607... 3032	Content: 11-Double open end wrench 6x7;8x9;10x11;12x13;14x15;16x17; 18x19;20x22;21x23;24x27;30x32mm	



**T5111S**



**11pc Double open end wrench set (SAE)**

Part no.	6/16.0/17.0/0.9'	2666g
754 0608S... 2932S	Content: 11-Double open end wrench 1/4"x5/16";5/16"x3/8";3/8"x7/16"; 1/2"x9/16";9/16"x5/8";5/8"x11/16"; 11/16"x3/4";13/16"x7/8";15/16"x1"; 15/16"x1-1/16";1-1/8"x1-1/4"	



**T5114**



**11pc Angle wrench set**

Part no.	6/16.6/17.6/0.9'	2760g
753 08...19	Content: 11-6pt.-6pt.Angle wrench 8;10;11;12;13;14;15;16;17;18;19mm	



**T5122**

**12pc Auto kit set**



Part no.	6/13.0/14.0/0.9'	2160g
	Content:	
5061-1	6-Fill/Drain plug key	
5061-2	5/16"Hex-3/8"Hex	
5061-3	8mmSq.-3/8"Sq.	
5061-4	11mmSq.-12mmHex	
5061-5	13mmSq.-14mmHex	
5061-6	17mmHex.-1/2"Hex	
5061-6	8mmHex-10mmHex	
8074 16M...	2-1/2"DR Magnetic spark plug socket	
20.6M	16mm & 20.6mm	
810421	1-Plug key holder 1/2"(F)x21mm(F)	
617	1-Telescope mirror stick/magnetic pick-up	
618	1-20pc feeler gauges 0.05mm to 1mm	
619	1-Oil filter strap wrench	



**T51210**

**12pc Flat gear wrench set**



Part no.	6/13.6/14.6/0.9'	2270g
	Content:	
757 08...19	12-Flat gear wrench	
	8;9;10;11;12;13;14;15;16;17;18;19mm	



**T51211**

**12pc Reversible gear wrench set**



Part no.	6/13.6/14.6/0.9'	2270g
	Content:	
757 08R...	12-Reversible gear wrench	
19R	8;9;10;11;12;13;14;15;16;17;18;19mm	

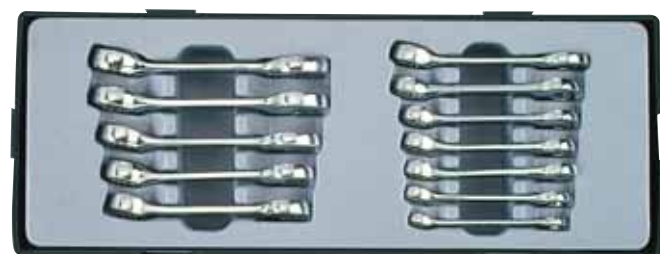

**T51214**

**12pc Midget combination wrench**



Part no.	6/6.5/7.5/0.9'	1090g
	Content:	
755S 08...	12-Midget combination wrench	
19	8; 9; 10; 11; 12; 13; 14; 15; 16; 17; 18; 19 mm	

## T51215



### 12pc Flat gear wrench & holder set (SAE)

Part no.	6/8.0/9.0/0.9'	1320g
757 5.16... 3.4	Content: 8-Flat gear wrench 5/16"; 3/8"; 7/16"; 1/2"; 9/16"; 5/8"; 11/16"; 3/4"	
831 210... 419	3-Gear wrench socket holder 1/4"DR.(10mm); 3/8"DR.(13mm); 1/2"DR.(19mm)	
831H210	1-Gear wrench bit holder 1/4"Hex(10mm)	



## T51215R



### 12pc Reversible gear wrench & holder set (SAE)

Part no.	6/8.0/9.0/0.9'	1320g
757 5.16R... 3.4R	Content: 8-Reversible gear wrench 5/16"; 3/8"; 7/16"; 1/2"; 9/16"; 5/8"; 11/16"; 3/4"	
831 210... 419	3-Gear wrench socket holder 1/4"DR.(10mm); 3/8"DR.(13mm); 1/2"DR.(19mm)	
831H210	1-Gear wrench bit holder 1/4"Hex(10mm)	



## T51226



### 12pc Flat ring wrench set

Part no.	6/8.0/9.0/0.9'	2327g
760M 0607... 3032	Content: 12-Flat ring wrench 6x7; 8x9; 10x11; 12x13; 14x15; 16x17; 18x19; 20x22; 21x23; 22x24; 26x28; 30x32	





**T51226A**

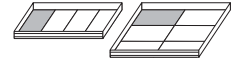

**12pc Double ring wrench set (15 degree bowed)**

Part no.	6/14.1/15.1/0.9'	2355g
760 0607A... 3032A	Content: 12-Double ring wrench 6x7; 8x9; 10x11; 12x13; 14x15; 16x17; 18x19; 20x22; 21x23; 22x24; 26x28; 30x32	

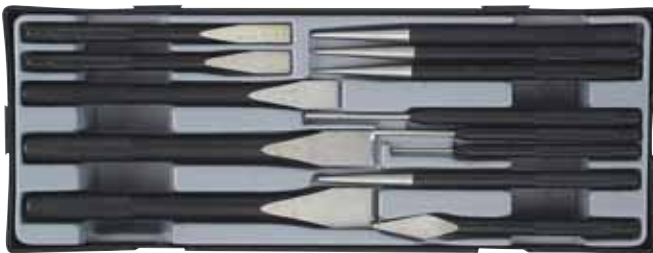

**T5131**



**13pc Chisel & punch set**

Part no.	6/14.0/15.0/0.9'	2340g
602 10150... 22200	Content: 5-Chisel 10(150mmL);12(150mmL) 15(180mmL);19(200mmL) 22(200mmL)	
603150	1-Cape chisel 150mmL	
604 2140... 4190	3-Pin punch 2(140mmL);3(150mmL);4(190mmL)	
606 2185... 4185	3-Taper punch 2(185mmL);3(185mmL);4(185mmL)	
6074185	1-Center punch 4(185mmL)	



**T5134**



**13pc Combination wrench set(SAE)**

Part no.	6/15.0/16.0/0.9'	2500g
755 1.4...1.0	Content: 13-Combination wrench 1/4";5/16";3/8";7/16";1/2";9/16";5/8"; 11/16";3/4";13/16";7/8";15/16";1"	



## T5135S



### 13pc Crowfoot flare nut wrench set(SAE)

Part no.	6/13.8/14.8/0.9'	2300g
7513 3.8...7.8	Content: 3/8" & 1/2"DR. 9-3/8"DR. 12pt. Crowfoot flare nut wrench 3/8";7/16";1/2";9/16";5/8";11/16";3/4"; 13/16";7/8"	
7514 15.16..1.0	2-1/2"DR. 12pt. Crowfoot flare nut wrench 15/16";1" 2-Locking extension	
808306	3/8"DR.-150mmL	
808405	1/2"DR.-125mmL	



## T5161



### 16pc Combination wrench set

Part no.	6/14.0/15.0/0.9'	2333g
755 06...24	Content: 16-Combination wrench 6;7;8;9;10;11;12;13;14;15;16;17; 18;19;22;24;mm	

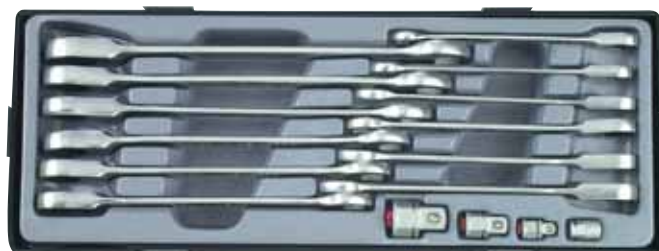

## T5164



### 16pc Flat gear wrench & holder set

Part no.	6/10.7/11.7/0.9'	1790g
757 08...19	Content: 12-Flat gear wrench 8;9;10;11;12;13;14;15;16;17;18;19 mm	
831 210...419	3-Gear wrench socket holder 1/4"DR.(10mm);3/8"DR.(13mm); 1/2"DR.(19mm)	
831H210	1-Gear wrench bit holder 1/4"Hex(10mm)	

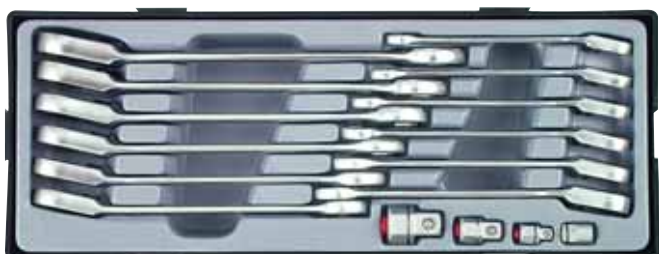

## T5164R



### 16pc Reversible gear wrench & holder set

Part no.	6/10.7/11.7/0.9'	1790g
757 08R...19R	Content: 12-Reversible gear wrench 8;9;10;11;12;13;14;15;16;17;18;19 mm	
831 210...419	3-Gear wrench socket holder 1/4"DR.(10mm); 3/8"DR.(13mm); 1/2"DR.(19mm)	
831H210	1-Gear wrench bit holder 1/4"Hex(10mm)	



**T5172**

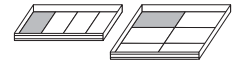

**17pc Crowfoot flare nut wrench set(MM)**

Part no.	6/13.8/14.8/0.9'	2300g
7513 10...22	Content:3/8" & 1/2"DR. 12-3/8"DR. 12pt. Crowfoot flare nut wrench 10;11;12;13;14;15;16;17;18;19; 21;22mm	
7514 23...26	3-1/2"DR. 12pt. Crowfoot flare nut wrench 23;24;26mm 2-Locking extension	
808306	3/8"DR.-150mmL	
808405	1/2"DR.-125mmL	



**T5181**



**18pc Combination wrench set**

Part no.	6/13.0/14.0/0.9'	2160g
755 06...23	Content: 18-Combination wrench 6;7;8;9;10;11;12;13;14;15;16;17;18; 19;20;21;22; 23mm	



**T51811**



**181pc River pliers set**

Part no.	6/8.4/9.4/0.9'	1400g
67801	Content: 1-River pliers	
51811-1	30-Aluminum rivet 4x8	
51811-2	30-Aluminum rivet 4x10	
51811-3	30-Aluminum rivet 4.8x8	
51811-4	30-Aluminum rivet 4.8x10	
51811-5	30-Stainless rivet 4x7	
51811-6	30-Stainless rivet 4x10	





**T5331**

**33pc Screw repair tools set**



Part no.	6/16.0/17.0/0.9'	2670g
8174	Content: 1-Impact driver	
15136 2...3	14-5/16" short bit Phillips PH.2;PH.3(36mmL)	
15236 2...3	Pozi driv PZ.2;PZ.3(36mmL)	
15336 09...11	Slotted 9;11mm(36mmL)	
15436 06...10	Hex 6;8;10mm(36mmL)	
15635 25...50	Star T25;T30;T40;T45;T50(35mmL)	
15180 2...3	4-5/16" long bit Phillips bit PH.2;PH.3(80mmL)	
15380 09...11	Slotted bit 9;11mm(80mmL)	
8095330	1-Bit adaptor 3/8"DR.x5/16"Hex	
81045A	1-Bit holder 1/2"DR.x5/16"	
818 06...12	4-Stud extractor 6;8;10;12mm	
6720912	3-Nut splitter 5/16"-1/2"(9-12mm)	
6721216	1/2"-5/8"(12-16mm)	
6721622	5/8"-7/8"(16-22mm)	
63005	1-5pc Screw extractor set 7/64";9/64";5/32";1/4";19/64"	



**T5861**

**86pc Grade nut fastener set**



Part no.	6/5.8/6.8/0.9'	960g
67802	Content: 1-Grade nut fastener (include 1pc M6x1.0 screw)	
5861-M3	3-Screw M3x0.5;	
5861-M4	M4x0.7;	
5861-M5	M5x0.8	
5861-S	1-Spanner	
5861-1	20-Instant blind nut 5.1mm	
5861-2	20-Instant blind nut 6.1mm	
5861-3	20-Instant blind nut 7.1mm	
5861-4	20-Instant blind nut 9.1mm	



**T905M2**

**5pc Auto body tools**



Part no.	6/5.0/6.0/0.9'	836g
905M2P1	Content: 1-Trim pad remover (big)	
905M2P2	1-Trim pad remover (small)	
905M2P3	1-Gasket scraper	
905M2P4	1-Radiator hose remover	
905M2P5	1-Cotter pin puller	

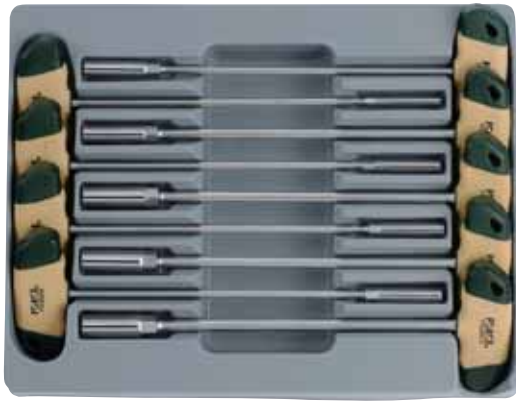

**2095**

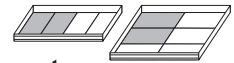

**9pc Hex nut driver T handle set**

Part no.	6/10.5/11.5/1.3'	1750g
774300 05... 13	Content: 9-Hex nut driver T handle 5;6;7;8;9;10;11;12;13 mm(300mmL)	



**2096**

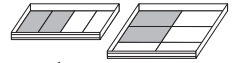

**9pc Star nut driver T handle set**

Part no.	6/10.5/11.5/1.3'	1750g
776 04...16	Content: 9-Star nut driver T handle E4;E5;E6;E7;E8;E10;E12;E14; E16(300mmL)	



**2097**



**9pc Hex screwdriver T handle set(MM)**

Part no.	6/7.0/8.0/1.3'	1166g
724 02...10	Content: 9-Hex screwdriver T handle 2;2.5;3;4;5;6;7;8;10 mm	



**2097B**



**9pc Hex ball point screwdriver T handle set**

Part no.	6/7.0/8.0/1.3'	1166g
725 02...10	Content: 9-Hex ball point screwdriver T handle 2;2.5;3;4;5;6;7;8;10 mm	



## 2097S

### 9pc Hex screwdriver T handle set(SAE)

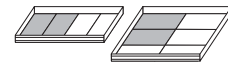

Part no.	6/7.0/8.0/1.3'	1166g
724 3.32... 3.8	Content: 9-Hex screwdriver T handle 3/32";7/64";1/8";5/32";3/16";7/32";1/4"; 5/16";3/8"	



## 2108

### 10pc Hammer screwdriver set

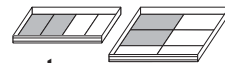

Part no.	6/14.4/15.4/1.3'	2400g
713 055M...14M	Content: 6-Hammer slotted screwdriver 5.5(125mmL);6.5(150mmL) 8(150mmL);10(200mmL); 12(200mmL);14(250mmL)	
711 1M...4M	4-Hammer Phillips screwdrivers PH.1(80mmL);Ph.2(100mmL) PH.3(150mmL);Ph.4(200mmL)	



## 2109

### 10pc Hammer screwdriver set



Part no.	6/14.4/15.4/1.3'	2400g
713 055M...14M	Content: 6-Hammer slotted screwdriver 5.5(125mmL);6.5(150mmL);8(150mmL); 10(200mmL);12(200mmL);14(250mmL)	
712 1M...4M	4-Hammer pozidriv screwdrivers PZ.1(80mmL);PZ.2(100mmL); PZ.3(150mmL);PZ.4(200mmL)	



## 2125

### 12pc Insulated screwdriver set



Part no.	6/6.8/7.8/1.3'	1140g
713 024N... 08N	Content: 7-Insulated slotted screwdriver 2.4(75mmL);3(100mmL);3.5(100mmL); 4(100mmL);5.5(125mmL);6.5(150mmL); 8(175mmL)	
711 0N...3N	4-Insulated Phillips screwdrivers PH.0(60mmL);PH.1(80mmL); PH.2(100mmL);PH.3(150mmL)	
2125PI	1-Induction circuit tester	



**2126**

**12pc Insulated screwdriver set**

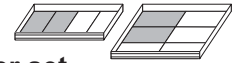

Part no.	6/6.8/7.8/1.3'	1140g
713 024N... 08N	Content: 7-Insulated slotted screwdriver 2.4(75mmL);3(100mmL);3.5(100mmL); 4(100mmL);5.5(125mmL);6.5(150mmL); 8(175mmL)	
712 0N...3N	4-Insulated Pozidriv screwdrivers PZ.0(60mmL);PZ.1(80mmL); PZ.2(100mmL);PZ.3(150mmL)	
2125P1	1-Induction circuit tester	



**2134**

**13pc Hex nut driver set**



Part no.	6/11.0/12.0/1.3'	1833g
744250 04...14	Content: 13-Hex nut driver 4;4.5;5;5.5;6;7;8;9;10;11;12;13; 14mm(250mmL)	



**2137**

**13pc Star screwdriver set**



Part no.	6/6.3/7.3/1.3'	1050g
716 05B...45B	Content: 13-Star screwdriver T5;T6;T7;T8;T9;T10;T15;T20;T25; T27;T30;T40;T45	



**2137T**

**13pc Star tamperproof screwdriver set**



Part no.	6/6.3/7.3/1.3'	1050g
717 05B...45B	Content: 13-Star tamper screwdriver T-5H;T-6H;T-7H;T-8H;T-9H;T-10H; T-15H;T-20H;T-25H;T-27H;T-30H; T-40H;T-45H	



## 2137YC

### 13pc Star screwdriver set

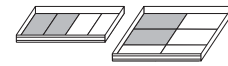

Part no.	10/10.5/12.0/1.9'	1050g
716 05...45	Content: 13-Star screwdriver T5;T6;T7;T8;T9;T10;T15;T20;T25; T27;T30;T40;T45	



## 2141

### 14pc Star screwdriver T handle set



Part no.	6/8.5/9.5/1.3'	1415g
726 06...55	Content: 14-Star screwdriver T handle T6;T7;T8;T9;T10;T15;T20;T25;T27; T30;T40;T45;T50;T55	



## 2141T

### 14pc Star tamperproof screwdriver T handle set



Part no.	6/8.5/9.5/1.3'	1415g
727 06....55	Content: 14-Star tamper screwdriver T handle T-6H;T-7H;T-8H;T-9H;T-10H;T-15H; T-20H;T-25H;T-27H;T-30H;T-40H; T-45H;T-50H;T-55H	



## 2142

### 14pc screwdriver set

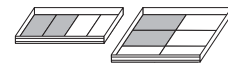

Part no.	6/6.3/7.3/1.3'	1050g
713 03B...08B	Content: 6-Slotted screwdriver 3mm(75mmL);3.5mm(100mmL); 4mm(100mmL);5.5(125mmL); 6.5mm(150mmL);8mm(175mmL)	
713 055BS...	2-Slotted stubby screwdrivers	
065BS	5.5mm(25mmL);6.5mm(25mmL)	
711 0B...3B	4-Phillips screwdrivers PH.0(60mmL);PH.1(80mmL); PH.2(100mmL);PH.3(150mmL)	
711 1BS...2BS	2-Phillips stubby screwdrivers PH.1(25mmL);PH.2(25mmL)	



## 2142YC

### 14pc screwdriver set

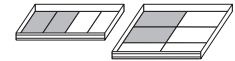

Part no.	10/11.8/13.3/1.9'	1180g
713 03...08	Content: 6-Slotted screwdriver 3mm(75mmL);3.5mm(100mmL); 4(100mmL);5.5(125mmL); 6.5(150mmL);8mm(175mmL)	
713 055S... 065S	2-Slotted stubby screwdrivers 5.5mm(38mmL);6.5mm(38mmL)	
711 0...3	4-Phillips screwdrivers PH.0(60mmL);PH.1(80mmL); PH.2(100mmL);PH.3(150mmL)	
711 1S...2S	2-Phillips stubby screwdrivers PH.1(38mmL);PH.2(38mmL)	



## 4215

### 21pc 1/2" Impact wrench socket set



Part no.	3/20.4/21.4/1'	6796g
445 10...24	Content: 1/2"DR. 5-6pt. Flank impact socket 10; 13; 17; 19; 24 mm	
44585	3-6pt. Flank impact thin-wall deep socket 17; 19; 21mm (85mmL)	
17TH...21TH 44585 15C...23C	5-Wheel nut 6pt. Flank impact socket (colored)15; 17; 19; 21; 23 mm	
8044125MPB	1-Impact extension (ball type) 125mm	
80541MPB	1-Universal joint (ball type)	
82442	1-Super duty impact ratchet wrench	
82546	1-Impact wrench (with grip)	
P2030	1-Pin 20L-φ3.0	
P2530	1-Pin 25L-φ3.0	
R1935	1-Ring φ19-φ3.5	
R2435	1-Ring φ24-φ3.5	



## 5048

### 4pc terminal & stripper pliers set



Part no.	6/12.1/13.1/1.2'	2010g
6801	Content: 1-Terminal pliers red, Blue, yellow	
6802	1-Terminal pliers 0.5;0.75;1.0;1.5;2.5;4	
6803	1-Terminal pliers 0.5-1;1.1-2.5;4-6	
6804	1-Stripper pliers	



### 50713

#### 7pc Auto body repair tool set

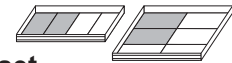

Part no.	6/37/38/1.2'	6120g
----------	--------------	-------

Content:	
62602	1-Pick & Finishing Hammer
62603	1-Light Shrinking Hammer
62604	1-Standard Bumping Hammer
68301	1-Utility Dolly
68302	1-Curved Dolly
68303	1-Heel Dolly
68304	1-Toe Dolly

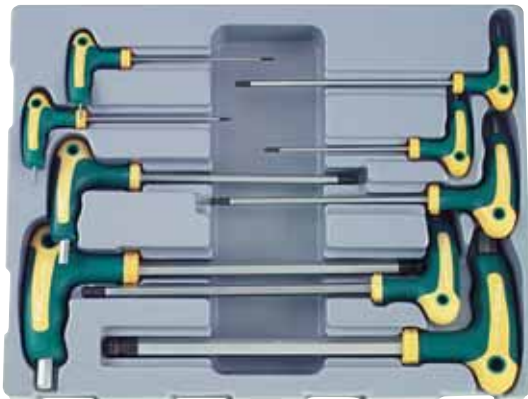

### 50910BS

#### 9pc Hex ball point grip key set (SAE)



Part no.	6/8.0/9.5/1.3'	1340g
----------	----------------	-------

Content:	
765 5.64...	9-Hex ball point grip key
1.2	5/64"; 3/32"; 1/8"; 5/32"; 3/16"; 1/4"; 5/16"; 3/8"; 1/2"

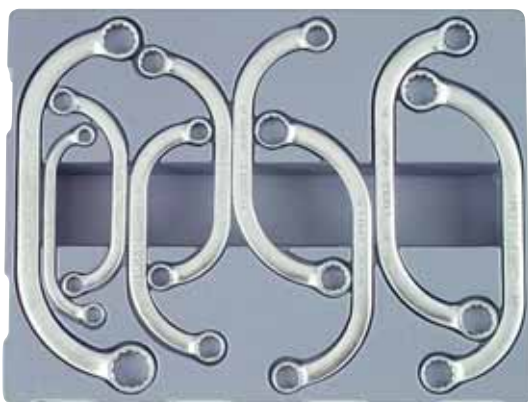

### 50911

#### 9pc Half-moon ring wrench



Part no.	6/8.3/9.8/1.3'	1390g
----------	----------------	-------

Content:	
761 0810...	9-Half-moon ring wrench
1922	8x10; 10x12; 11x13; 12x14; 13x15; 14x17; 16x18; 17x19; 19x22 mm

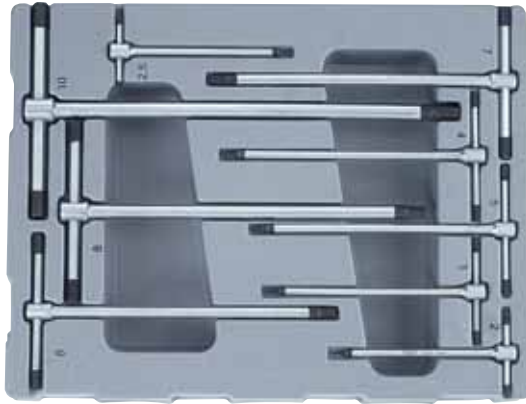

**50912**

**9pc T shaped hex key**

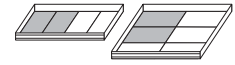

Part no.	6/7.9/9.4/1.3'	1310g
764 02T...	Content: 12-T shape hex key	
10T	2; 2.5; 3; 4; 5; 6; 7; 8; 10 mm	

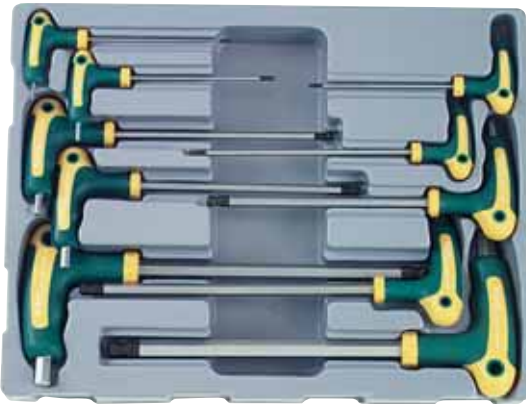

**5106B**

**10pc Hex ball point grip key set**

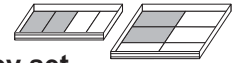

Part no.	6/8.5/10.0/1.3'	1420g
765 02G...	Content: 10-Hex ball point grip key	
12G	2;2.5;3;4;5;6;7;8;10;12mm	

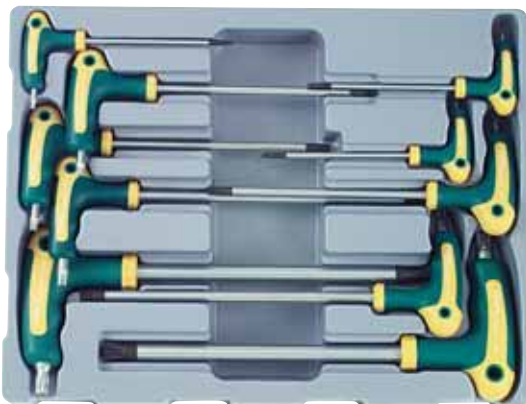

**51010T**

**10pc Star tamperproof grip key set**



Part no.	6/9.3/10.8/1.3'	1540g
767 10G...	Content: 10-Star tamperproof grip key	
55G	T-10H; T-15H; T-20H; T-25H; T-27H; T-30H; T-40H; T-45H; T-50H; T-55H	





**5138**



**13pc Quakeproof and safe punch set**

Part no.	6/13.7/15.2/1.3'	2280g
Content:		
604 2140Q... 14290Q	9-Quakeproof and safe pin punch 2(140mmL); 3(150mmL); 4(190mmL); 5(200mmL); 6(210mmL); 8(215mmL); 10(230mmL); 12(280mmL); 14(290mmL)	
606 4185Q... 6185Q	3-Quakeproof and safe taper punch 4(185mmL); 5(185mmL); 6(185mmL)	
6076185Q	1-Quakeproof and safe center punch 6(185mmL)	



**5139**

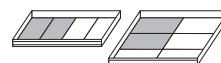

**13pc Quakeproof chisel & punch set**

Part no.	6/11.7/13.2/1.3'	1950g
Content:		
602 12150Q... 22200Q	4-Quakeproof and safe chisel 12(150mmL); 15(180mmL); 19(200mmL); 22(200mmL)	
603150Q	1-Cape chisel 3(150mmL)	
604 2140Q... 8215Q	6-Quakeproof and safe pin punch 2(140mmL); 3(150mmL); 4(190mmL); 5(200mmL); 6(210mmL); 8(215mmL)	
6066185Q	1-Quakeproof and safe taper punch 6(185mmL)	
6076185Q	1-Quakeproof and safe center punch 6(185mmL)	

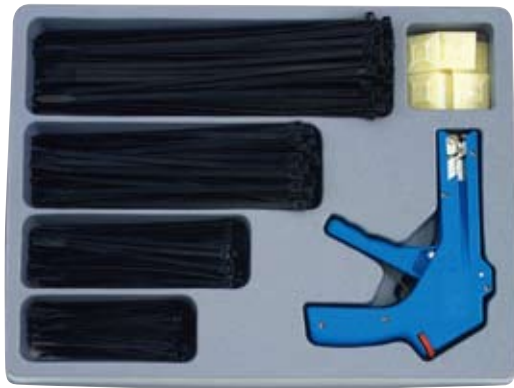

**54111**

**411pc Tie tape pliers kits**

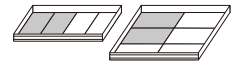

Part no.	6/5/6/1.2'	820g
Content:		
54111P1	1-Tie down pliers	
54111P2	100-Tie tape 2.5x102mmL	
54111P3	100-Tie tape 3.2x150mmL	
54111P4	100-Tie tape 3.6x182mmL	
54111P5	100-Tie tape 4.8x200mmL	
54111P6	10-Two-way baseplate	



**50823**

**8pc Utility tool set**

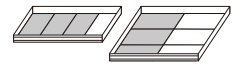

Part no.	6/9.6/10.6/1.1'	1592g
Content:		
5096P2	1-Auto center punch	
5096P3	1-Stainless steel straight ruler 30cm	
5096P7	1-Steel scribe	
5096P803	1-3m measuring tape	
66301	1-Super heavy duty hacksaw	
66301-B	1-Saw blade 300mmL for 66301	
6982	1-Technician's scissors	
9U3001	1-Brass & Nylon scrape brushes	

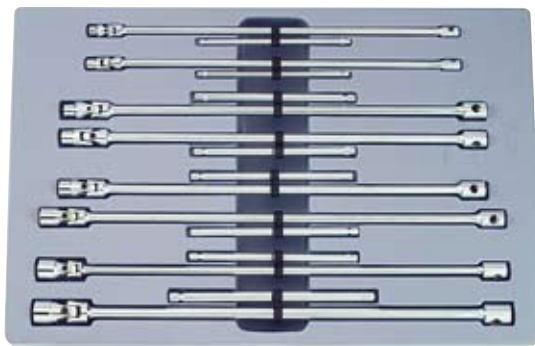

**50816**

**8pc Universal long nut driver**



Part no.	4/16.4/17.5/3.3'	4090g
Content:		
784 207U...	8-Universal long nut driver	
419U	7; 8; 10; 12; 13; 14; 17; 19 mm	



**50619**

**6pc Wheel special tools kits set**

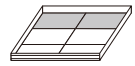

Part no.	6/29.4/30.4/1.8'	4900g
----------	------------------	-------

Part no.	Content:
6474535	1-1/2"DR.Lock torques wrench(Tone control)
44585 17	3-1/2"DR.Impact deep socket
...21	17mm;19mm;21mm(85mmL)
681500	1-Foldable cross-handle socket wrench(500mmL)
	17mm;19mm;21mm
	1/2" Square
6821	1-Wheel balancing weight tool

# The basics of **CABIN II** are as follows :

For long term, **FORCE CABIN** has been introduced to users as a concept that tool combination is divided into small units and by putting different units together at will, users can get a tool set that is suitable for a certain job focus.

**FORCE CABIN II** is an enhancement on this idea.



● Proportionate to each other



● Removable cover

● A tenon for assembling two cabin boxes.



For each tool, an exact cut is produced with computer technology which grants easy and quick deployment.

The EVA foam is chemical-based and extremely flexible.

The exact cuts let recognize immediately where each tool is seated. That saves time and money.

Dual color : the upper layer is dark gray, the lower red.

# What is good about **FORCE CABIN II** ?

- When deployed in the trolleys, Cabin boxes can be assembled with each other perfectly in the drawers without wasting any space.



- When you need one of them for a job mission outside, just take it out and put on the cover.



- When you need some of them for a job mission outside, you can also put small units together in a cabin box and then put on cover.





### K20711

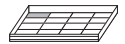

#### 7pc Five-sided star tamper socket bit

Part no.	24/5.3/6.3/0.8'	220g
32F32 10...40	Content: 7-1/4"DR. Five-sided star tamper socket bit TS10; TS15; TS20; TS25; TS27; TS30; TS40	



### K3021



#### 2pc 3/8"DR. Torque adapter set (spark plug special)

Part no.	24/12/13/0.8'	500g
832 318...324	Content: 3/8"DR. 2-Torque adapter 18Nm; 24Nm	



### K3068



#### 6pc 3/8" Spline socket bit set

Part no.	24/10.8/11.8/0.8'	450g
33850 05...12	Content: 3/8"DR.. 6-Spline socket bit 50mmL M5; M6; M8; M9; M10; M12	



### K2047



#### 4pc 1/4"DR. Wobble extension set

Part no.	24/9.6/10.6/1.5'	402g
8042 050W...150W	Content: 1/4"DR. 4-Wobble extension 2"; 3"; 4"; 6"	



**K2139**

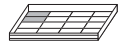

**13pc 1/4"DR. 6pt. Flank impact socket set**

Part no.	24/21.1/22.1/1.5'	880g
425 04...13	Content: 1/4"DR. 12-6pt. Flank impact socket (MM) 4; 4.5; 5; 5.5; 6; 7; 8; 9; 10; 11; 12; 13 mm	
82421	1-Palm impact ratchet wrench	



**K2139-2**

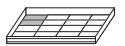

**13pc 1/4"DR. 6pt. Flank impact socket set**

Part no.	24/23.2/24.2/1.5'	965g
425 04...13	Content: 1/4"DR. 12-6pt. Flank impact socket (MM) 4; 4.5; 5; 5.5; 6; 7; 8; 9; 10; 11; 12; 13 mm	
82422	1-Stubby impact ratchet wrench	



**K2205**



**20pc 1/4" 6pt. Flank socket set (SAE)**

Part no.	24/15.8/16.8/1.5'	660g
525 5.32...1.2	Content: 1/4"DR. 10-6pt. Flank socket 5/32"; 3/16; 7/32; 1/4"; 6/32"; 5/16"; 11/32"; 3/8"; 7/16"; 1/2"	
52550 5.32...1.2	10-6pt. Flank deep socket (50mmL) 5/32"; 3/16; 7/32; 1/4"; 6/32"; 5/16"; 11/32"; 3/8"; 7/16"; 1/2"	



**K2231**



**23pc 1/4"DR. 6pt. Flank impact socket set (S&M)**

Part no.	24/24.7/25.7/1.5'	1030g
425 04...13	Content: 1/4"DR. 12-6pt. Flank impact socket (MM) 4; 4.5; 5; 5.5; 6; 7; 8; 9; 10; 11; 12; 13 mm	
425 5.32...1.2	10-6pt. Flank impact socket (SAE) 5/32"; 3/16"; 7/32"; 1/4"; 9/32"; 5/16"; 11/32"; 3/8"; 7/16; 1/2"	
82421	1-Palm impact ratchet wrench	



## K2231-2

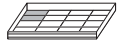

### 23pc 1/4"DR. 6pt. Flank impact socket set (S&M)

Part no.	24/26.9/27.9/1.5'	1120g
425 04...13	Content: 1/4"DR. 12-6lank impact socket (MM) 4; 4.5; 5; 5.5; 6; 7; 8; 9; 10; 11; 12; 13 mm	
425 5.32...1.2	10-6pt. Flank impact socket (SAE) 5/32"; 3/16"; 7/32"; 1/4"; 9/32"; 5/16"; 11/32"; 3/8"; 7/16; 1/2"	
82422	1-Stubby impact ratchet wrench	



## K2406



### 40pc 1/4" Socket bit set

Part no.	24/19/20/1.5'	790g
	Content: 1/4"DR. 40-Socket bit (32mmL)	
32132 0...3	Phillips PH.0; PH.1; PH.2; PH.3	
32232 0...3	Poqidriv PZ.0; PZ.1; PZ.2; PZ.3	
32332 04...065	Slotted 4; 5.5; 6.5 mm	
32432 03...08	Hex 3; 4; 5; 6; 7; 8; mm	
32632 08...40	Star T8; T10; T15; T20; T25; T27; T30; T40	
32732 08...40	Star tamper T-8H; T-10H; T-15H; T-20H; T-25H; T-27H; T-30H; T-40H	
32F32 10...40	Five-sided star tamper TS10; TS15; TS20; TS25; TS27; TS30; TS40	



## K2463

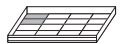

### 46pc 1/4"DR. Ratchet spinner set

Part no.	24/17.8/18.8/1.5'	740g
	Content: 1/2"DR.	
52Q 04...14	13-Spline socket 4; 4.5; 5; 5.5; 6; 7; 8; 9; 10; 11; 12; 13; 14 mm	
	31-1/4" bit (25mmL)	
12125 0...3	Phillips PH.0; PH.1; PH.2; PH.3	
12225 0...3	Poqidriv PZ.0; PZ.1; PZ.2; PZ.3	
12325 03...065	Slotted 3; 4; 5; 5.5; 6.5 mm	
12425 03...08	Hex 3; 4; 5; 6; 7; 8 mm	
12725 10...40	Star tamperproof T10; T15; T20; T25; T27; T30; T40	
81022M	Spline M4; M5; M6; M8; M10	
8149	1-Magnetic bit holder 1/4"(F)x1/4(F) 1-Ratchet spinner	





## K2612

### 61pc 1/4" bit set

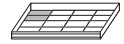

Part no.	24/14.2/15.2/1.5'	590g
	Content: 1/4"DR. 60-bit 25mmL	
12125 0...3	Phillips PH.0; PH.1; PH.2; PH.3	
12225 0...3	Pozidriv PZ.0; PZ.1; PZ.2; PZ.3	
12325 03...065	Slotted 3; 4; 5; 5.5; 6.5 mm	
12425 015...06	Hex 1.5; 2; 2.5; 3; 4; 5; 6 mm	
12425 1.16...1.4	Hex 1/16"; 3/32"; 1/8"; 5/32"; 3/16"; 7/32"; 1/4"	
12625 04...40	Star T4; T5; T6; T7; T8; T9; T10; T15; T20; T25; T27; T30; T40	
12725 06...40	Star tamper T-6H; T-7H; T-8H; T-9H; T-10H;	
12F25 08...40	T-15H; T-20H; T-25H; T-27H; T-30; T-35H; T-40H	
	Five-sided star tamper TS8; TS10; TS15; TS20; TS25; TS27; TS30; TS40	
81260Q	1-Magnetic quick-release bit holder	



## K3096

### 9pc 3/8" Hex socket bit set(SAE)

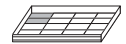

Part no.	24/16.8/17.8/1.5'	700g
	Content: 3/8"DR..	
334050 1.8...1.2	9-Hex socket bit (50mmL) 1/8"; 5/32"; 3/16"; 7/32"; 1/4"; 5/16"; 3/8"; 7/16"; 1/2"	



## K3104

### 10pc 3/8" Hex socket bit set

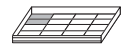

Part no.	24/17.8/18.8/1.5'	740g
	Content: 3/8"DR.	
334050 03...12	10-Hex socket bit (50mmL) 3; 4; 5; 5.5; 6; 7; 8; 9; 10; 12mm	



### K3123

12pc 3/8" Star socket bit set



Part no.	24/19.2/20.2/1.5'	800g
33650 08...60	Content: 3/8"DR. 12-Star socket bit (50mmL) T8; T10; T15; T20; T25; T27; T30; T40; T45; T50; T55; T60	



### K3123T

12pc 3/8" Star tamper socket bit set



Part no.	24/19.2/20.2/1.5'	800g
33750 08...60	Content: 3/8"DR. 12-Star tamper socket bit (50mmL) T-8H; T-10H; T-15H; T-20H; T-25H; T-27H; T-30H; T-40H; T-45H; T-50H; T-55H; T-60H	



### K3133

13pc Impact wrench socket set

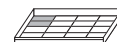

Part no.	24/28.2/29.2/1.5'	1176g
435 06...19	Content: 3/8"DR. 11-6pt. Flank impact socket 06; 07; 08; 10; 11; 12;13; 14; 15; 17; 19 mm	
82432	1-Palm impact ratchet wrench	
8043075MPB	1-Impact extension (ball)	



### K3133-3

13pc Impact wrench socket set



Part no.	24/30.5/31.5/1.5'	1269g
435 06...19	Content: 3/8"DR.. 11-6pt. Flank impact socket 06; 07; 08; 10; 11; 12;13; 14; 15; 17; 19 mm	
82433	1-Stubby impact ratchet wrench	
8043075MPB	1-Impact extension (ball)	



### K4032

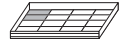

#### 3pc 1/2"DR. Wheel nut impact socket set

Part no.	24/22.3/23.3/1.5'	925g
4458517C...21C	Content: 1/2"DR. 3-Wheel nut 6pt. Flank impact socket 17; 19; 21mm (85mmL)	



### K4033

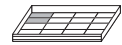

#### 3pc Wheel nut deep impact socket set

Part no.	24/33.6/34.6/1.5'	1404g
445150 17C...21C	Content: 1/2"DR. 3-Wheel nut 6pt. Flank deep impact socket 17; 19; 21mm (150mmL)	



### K4086

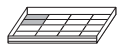

#### 8pc 1/2" Spline socket bit set

Part no.	24/24/25/1.5'	1000g
348055 05...12	Content: 1/2"DR. 7-Spline socket bit (55mmL) M5; M6; M8; M9; M10; M12; M14	
34805516T	1-Spline security socket bit M16 (55mmL)	



### K4087

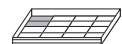

#### 8pc Adapter set

Part no.	24/42/43/1.5'	1750g
809 23...86	Content: 8-Adapter 1/4"(F)x3/8"(M); 3/8"(F)x1/4"(M); 3/8"(F)x1/2"(M); 1/2"(F)x3/8"(M); 1/2"(F)x3/4"(M); 3/4"(F)x1/2"(M); 3/4"(F)x1"(M); 1"(F)x3/4"(M)	



## K64706



### 47pc Torque driver set

Part no.	24/21.7/22.7/1.5'	905g
Content: 1/4"DR.		
6472150	1-Torque driver	
81022	1-Bit holder 1/4"(F)x1/4"inhex	
8042100	1-Extension 4"	
12125 0...3	4-Phillips bit (25mmL) PH.0; PH.1; PH.2; PH.3	
12223 0...3	4-Pozidriv bit (25mmL) PZ.0; PZ.1; PZ.2; PZ.3	
12325 03...065	5-Slotted bit 3; 4; 5; 5.5; 6.5 mm	
12425 015...06	6-Hex bit 1.5; 2; 3; 4; 5; 6 mm	
124R25 1...3	3-Square bit 1; 2; 3 mm	
12625 06...40	11-Star bit T6; T7; T8; T9; T10; T15; T20; T25; T27; T30; T40	
12725 06...40	11-Star tamperproof bit T-6H; T-7H; T-8H; T-9H; T-10H; T-15H; T-20H; T-25H; T-27H; T-30H; T-40H	



## K64708



### 49pc Torque driver set

Part no.	24/16.4/17.4/1.5'	684g
Content: 1/4"DR.		
647D2180	1-Torque driver 1/4"inhex	
8092225	1-Bit adaptor 1/4"Hex-1/4"Sq.	
81260	1-Magnetic inhex extension 60mmL	
12125 0...3	4-Phillips bit (25mmL) PH.0; PH.1; PH.2; PH.3	
12223 0...3	4-Pozidriv bit (25mmL) PZ.0; PZ.1; PZ.2; PZ.3	
12325 03...065	5-Slotted bit 3; 4; 5; 5.5; 6.5 mm	
12425 015...06	6-Hex bit 1.5; 2; 3; 4; 5; 6 mm	
124R25 1...3	3-Square bit 1; 2; 3 mm	
12625 06...40	13-Star bit T4; T5; T6; T7; T8; T9; T10; T15; T20; T25; T27; T30; T40	
12725 06...40	11-Star tamperproof bit T-6H; T-7H; T-8H; T-9H; T-10H; T-15H; T-20H; T-25H; T-27H; T-30H; T-40H	



## K904U4

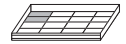

### 4pc Hook & pick set

Part no.	24/7.4/8.4/1.5'	309g
Content:		
904U4P1	1-Full hook	
904U4P2	1-90° hook	
904U4P3	1-Angel hook	
904U4P4	1-Straight pick	



## K20811

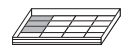

### 8pc 1/4" Accessory set

Part no.	12/11/12/1.4'	920g
Content: 1/4"DR.		
802215	1-20 teeth ratchet handle	
802223	1-72 teeth flexible ratchet handle	
8042 050...150	3-Extension 2"; 4"; 6"	
80521	1-Universal joint	
8143	1-Spinner	
8032115	1-Sliding T handle	



## K2362



### 36pc 1/4" Socket set

Part no.	12/12.6/13.6/1.4'	1050g
Content: 1/4"DR.		
525 04...13	12-6pt. Flank socket 4; 4.5; 5; 5.5; 6; 7; 8; 9; 10; 11; 12; 13 mm	
52550 04...13	12-6pt. Flank deep socket (50mmL) 4; 4.5; 5; 5.5; 6; 7; 8; 9; 10; 11; 12; 13 mm	
526 04...10	6-Star socket E4; E5; E6; E7; E8; E10	
52650 04...10	6-Star deep socket (50mmL) E4; E5; E6; E7; E8; E10	



### K3203

#### 20pc 3/8" Star socket set

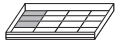

Part no.	12/6.4/7.4/1.4'	1070g
536 04...16	Content: 3/8"DR. 10-Star socket E4; E5; E6; E7; E8; E10; E11; E12; E14; E16	
53655 04...16	10-Star deep socket (55mmL) E4; E5; E6; E7; E8; E10; E11; E12; E14; E16	



### K4044

#### 4pc 1/2"DR. Wobble extension set



Part no.	12/14.5/15.5/1.4'	1211g
8044	Content: 1/2"DR. 4-Wobble extension	
050W...250W	2"; 5"; 8"; 10"	



### K4079

#### 7pc Impact adapter set (ball type)

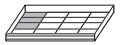

Part no.	12/22.6/23.6/1.4'	1880g
809	Content: 8-Impact Adapter (ball type)	
32MPB...86MPB	3/8"(F)x1/4"(M); 3/8"(F)x1/2"(M); 1/2"(F)x3/8"(M); 1/2"(F)x3/4"(M); 3/4"(F)x1/2"(M); 3/4"(F)x1"(M); 1"(F)x3/4"(M)	



### K4088

#### 8pc Impact adapter set (pin type)

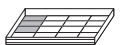

Part no.	12/41.2/42.2/1.4'	3430g
809	Content: 8-Impact Adapter (pin type)	
32MPP...812MPP	3/8"(F)x1/4"(M); 3/8"(F)x1/2"(M); 1/2"(F)x3/8"(M); 1/2"(F)x3/4"(M); 3/4"(F)x1/2"(M); 3/4"(F)x1"(M); 1"(F)x3/4"(M); 1"(F)x1-1/2"(M)	



### K41016

10pc 1/2" Ribe socket bit set

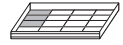

Part no.	12/20/21/1.4'	1165g
349100 05...16	Content: 1/2"DR. 10-Ribe socket bit (100mmL) M5; M6; M7; M8; M9;M10; M12; M13; M14; M16	



### K41110

11pc 1/2" Hex socket bit set



Part no.	12/18.4/19.4/1.4'	1530g
344055 04...12	Content: 1/2"DR. 11-Hex socket bit 4; 5; 6; 7; 8; 9; 10; 12; (55mmL)	
34406514	14 (65mmL)	
344070 17...19	17; 19; (70mmL)	



### K4188

18pc 1/2" 6pt. Flank socket set



Part no.	12/23.6/24.6/1.4'	1965g
545 10...32	Content: 1/2"DR. 18-6pt. Flank socket 10; 11; 12; 13; 14; 15; 16; 17; 18; 19; 21; 22; 23; 24; 26; 27; 30; 32 mm	



### K50411

4pc Star double gear flat wrench

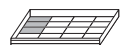

Part no.	12/9.8/10.8/1.4'	819g
828 0608...2024	Content: 4-Star double gear flat wrench E6xE8; E10xE12; E14xE18; E20xE24	



### K50819

#### 8pc Oil changing tool kit



Part no.	12/15.1/16.1/1.4'	1262g
Content:		
5061-1	6-Fill/Drain plug key	
5061-2	5/16"Hex - 3/8"Hex	
5061-3	8mmSq. - 3/8"Sq.	
5061-4	11mmSq. - 12mmHex	
5061-5	13mmSq. - 14mmHex	
5061-6	17mmHex - 1/2"Hex	
810421	8mmHex - 10mmHex	
619	1-Plug key holder 1/2"(F)x21mm(F)	
	1-Oil filter strap wrench	



### K3069

#### 6pc Spark plug torque set



Part no.	6/12.2/13.2/0.8'	2035g
Content:		
8073250	3-Magnetic Long spark plug socket	
14M...20.6M	14; 16; 20.6 mm	
8323 18...24	2-Torque adapter	
	18; 24 Nm	
618	1-Feeler gauges 20 blades 0.05mm to 1mm	



### K30713

#### 7pc 3/8" Accessory set



Part no.	6/10.9/11.9/0.8'	1810g
Content: 3/8"DR.		
802315	1-30 teeth ratchet handle	
802319	1-30 teeth stubby ratchet handle	
802323	1-72 teeth flexible ratchet handle	
80531	1-Universal joint	
8043 075...250	2-Extension 3" & 10"	
80633	1-Adaptor for extension	
	3/8"(F)x3/8"(M)	



### K3242

#### 24pc 3/8" 6pt. Flank socket set



Part no.	6/12.3/13.3/0.8'	2050g
Content: 3/8"DR.		
535 10...22	12-6pt. Flank socket	
	10; 11; 12; 13; 14; 15; 16; 17; 18; 19; 21; 22 mm	
53563 10...22	12-6pt. Flank deep socket	
	10; 11; 12; 13; 14; 15; 16; 17; 18; 19; 21; 22 mm	





## K4034

### 3pc 1/2" Accessory set



Part no.	6/13.5/14.5/0.8'	2250g
	Content: 1/2"DR.	
8334300	1-Adjustable handle(turn-lock design)	
802433	1-36 teeth Ratchet handle	
803A4300	1-Sliding T handle	



## K4057-15

### 5pc Accessory set



Part no.	6/13.7/14.7/0.8'	2280g
	Content: 1/4"DR.	
802415	1-Ratchet handle (36 teeth)	
8044 125...250	2-Extension 5" & 10"	
8034250	1-Sliding T handle	
80541	1-Universal joint	



## K4099

### 9pc Wheel nut impact socket set

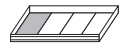

Part no.	6/15.3/16.3/0.8'	2505g
	Content: 1/2"DR.	
44585 14C...27C	9-Colored impact socket (85mmL) 14; 15; 17; 19; 21; 22; 23; 24; 27mm	



## K4204

### 20pc 1/2" Star & tamper socket bit set



Part no.	6/12/13/0.8'	2000g
	Content: 1/2"DR.	
346055 20...70	10-Star socket bit (55mmL) T20; T25; T27; T30; T40; T45; T50; T55; T60; T70	
347055 20...70	10-Star tamper socket bit (55mmL) T-20H; T-25H; T-27H; T-30H; T-40H; T-45H; T-50H; T-55H; T-60H; T-70H	



## K5043A

### 4pc Snap ring pliers set



Part no.	6/6.6/7.6/0.8'	1100g
Content:		
4-Circlip pliers		
609ASO	External straight tip 1.8mm for opening	
609ASC	Internal straight tip 1.8mm for closing	
609ABO	External 90° Bent tip 1.8mm for opening	
609ABC	Internal 90° Bent tip 1.8mm for closing	



## K50625

### 6pc Double gear flat wrench set



Part no.	6/6.8/7.8/0.8'	1140g
Content:		
6-Double gear flat wrench		
827M0809...1719	8x9; 10x11; 12x13; 14x15; 16x18; 17x19	



## K50629

### 6pc Measuring tool set



Part no.	6/5.7/6.7/0.8'	947g
Content:		
5096P1	1-Stainless steel vernier caliper	
5096P2	1-Auto center punch	
5096P3	1-Stainless steel straight rule 30cm	
5096P4	1-Stainless steel protractor	
5096P7	1-Steel scribe	
5096P8	1-5M measuring tape	



## K50718

### 7pc Spark plug socket combination set



Part no.	6/13.7/14.7/0.8'	2278g
Content: 3/8"DR.		
802318	1-Flexible ratchet handle	
8323 18...24	2-Torque adapter 18Nm; 24Nm	
8073250	2-Magnetic spark plug socket 250mmL	
16M...20.6M	16; 20.6 mm	
2-Magnetic spark plug socket		
8073 16M...20.6M	16; 20.6 mm	



### K51214

#### 12pc Midget combination wrench set



Part no.	6/7.5/8.5/0.8'	1256g
755S 08...19	Content: 12-Midget combination wrench 8; 9; 10; 11; 12; 13; 14; 15; 16; 17; 18; 19 mm	



### K51216

#### 12pc Stubby flat gear wrench set



Part no.	6/7.5/8.5/0.8'	1256g
757S 08...19	Content: 12-Stubby flat gear wrench 8; 9; 10; 11; 12; 13; 14; 15; 16; 17; 18; 19 mm	

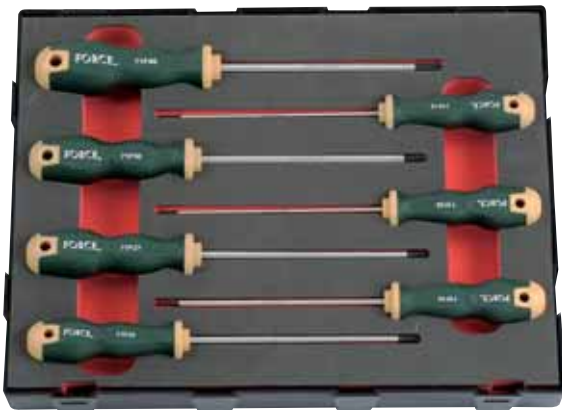

### K20717

#### 7pc Five-sided star tamperproof screwdriver set

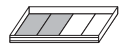

Part no.	6/8.0/9.0/1.5'	1342g
71F 10...40	Content: 7-Five-sided star tamperproof screwdriver TS10; TS15; TS20; TS25; TS27; TS30; TS40	

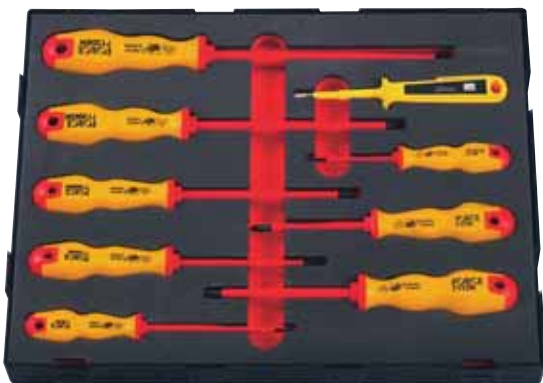

### K20911

#### 9pc Insulated screwdriver set

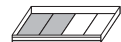

Part no.	6/9.8/10.8/1.5'	1628g
713 03N...08N	Content: 5-Insulated slotted screwdriver 3mm(100mmL); 4mm(100mmL); 5.5mm(125mmL); 6.5mm(150mmL); 8mm(175mmL)	
711 0N...2N	3-Insulated Phillips screwdriver PH.0(60mmL); PH.1(80mmL); PH.2(100mmL)	
88403	1-Screwdriver probe voltage tester Testing range: 80~250V AC	



## K20912



### 9pc Hex nut driver set

Part no.	6/13.5/14.5/1.5'	2244g
744250 05...13	Content: 9-Hex nut driver 5; 6; 7; 8; 9; 10; 11; 12; 13 mm	



## K2211



### 21pc Screwdriver & Hex key set

Part no.	6/12.1/13.1/1.5'	2014g
713 03B...08B	Content: 6-Slotted screwdriver 3mm(75mmL); 3.5mm(100mmL); 4mm(100mmL); 5.5mm(125mmL); 6.5mm(150mmL); 8mm(175mmL)	
713065BS	1-Stubby slotted screwdriver 6.5mm(25mmL)	
711 1B...2B	2-Phillips screwdriver PH.1(80mmL); PH.2(100mmL)	
7112BS	1-Stubby Phillips screwdriver PH.2(25mmL)	
5116	11pc Hex key	
764 015...12	1.5; 2; 2.5; 3; 4; 5; 6; 7; 8; 10; 12 mm	



## K2232



### 23pc Star screwdriver and key set

Part no.	6/12.9/13.9/1.5'	2150g
716 08B...40B	Content: 8-Star screwdriver T8; T10; T15; T20; T25; T27; T30; T40	
5151	15pc Star key set	
766 06...60	T6; T7; T8; T9; T10; T15; T20; T25; T27; T30; T40; T45; T50; T55; T60	



## K2232T



### 23pc Star tamperproof screwdriver and key set

Part no.	6/12.9/13.9/1.5'	2150g
717 08B...40B	Content: 1/4"DR. 8-Star tamper screwdriver T-8H; T-10H; T-15H; T-20H; T-25H; T-27H; T-30H; T-40H	
5151T	15pc Star tamper key set	
767 06...60	T-6H; T-7H; T-8H; T-9H; T-10H; T-15H; T-20H; T-25H; T-27H; T-30H; T-40H; T-45H; T-50H; T-55H; T-60H	



## K4188D



### 18pc 1/2" 6pt. Flank deep socket set

Part no.	6/23.9/24.9/1.5'	3980g
54577 10...32	Content: 1/2"DR. 18-6pt. Flank deep socket 10; 11; 12; 13; 14; 15; 16; 17; 18; 19; 21; 22; 23; 24; 26; 27; 30; 32 mm	



## K4492



### 49pc Bit set

Part no.	6/17.6/18.6/1.5'	2920g
	Content: 1/2"DR.	
	14-10mm Hex bit	
17430 04...12	4; 5; 6; 7; 8; 10; 12; (30mmL)	
17475 03...12	4; 5; 6; 7; 8; 10; 12; (75mmL)	
	18-10mm Star bit	
17630 20...60	T20; T25; T27; T30; T40; T45; T50; T55; T60; (30mmL)	
17675 30...60	T20; T25; T27; T30; T40; T45; T50; T55; T60; (75mmL)	
	10-10mm Spline bit	
17830 05...12	M5; M6; M8; M10; M12; (30mmL)	
17875 05...12	M5; M6; M8; M10; M12; (75mmL)	
34610070	1-Star socket bit T70 (100mmL)	
34607080	1-Star socket bit T80 (70mmL)	
346200 30...45	3-Star socket bit (200mmL) T30; T40; T45	
810 37...47	2-Bit holder 1/2"DR.x10mm & 3/8"DR.x10mm	



### K5059

#### 5pc Combination wrench set



Part no.	6/15.8/16.8/1.5'	2641g
755 23...32	Content: 5-Combination wrench 23; 24; 27; 30; 32 mm	



### K50626

#### 6pc Pliers set



Part no.	6/14.1/15.1/1.5'	2350g
610B200	Content: 1-Long nose pliers 8"	
610B200B	1-Bent long nose pliers 8"	
611B175	1-Combination pliers 7"	
612B175	1-Diagonal pliers 7"	
6804B160	1-Wire stripper pliers 6.5"	
613B250	1-waterpump pliers 10"	



### K50627

#### 6pc Utility tool set



Part no.	6/14.4/15.4/1.5'	2400g
649250A	Content: 1-Adjustable gauged wrench 10"	
614250	1-Locking pliers 10"	
5055P4	1-Utility knife (incl. 2pc blades)	
66303	1-Hacksaw 315mmL	
5096P803	1-Measuring tape 3M	
6982	1-Technician's scissors 145mmL	



### K50628

#### 6pc Insulated pliers set



Part no.	6/14.1/15.1/1.5'	2350g
6904160	Content: 1-Insulated long nose pliers 6"	
6903180	1-Insulated combination pliers 7"	
6907250	1-Insulated water pump pliers (Curved jaw) 10"	
6905160	1-Insulated diagonal cutting pliers 6"	
6909250	1-Insulated cable cutter 10"	
6912160	1-Insulated wire stripper pliers 6"	



### K50818



#### 8pc Hammer chisel set

Part no.	6/17.7/18.7/1.5'	2950g
Content:		
616300	1-Engineer hammer 300g	
616400	1-Rubber hammer 400g	
602	3-Quakeproof and safe chisel	
15180Q...22200Q	15(180mmL); 19(200mmL); 22(200mmL)	
604	2-Quakeproof and safe pin punch	
4190Q...5200Q	4(190mmL); 5(200mmL)	
6076185Q	1-Quakeproof and safe center punch	
	6(185mmL)	

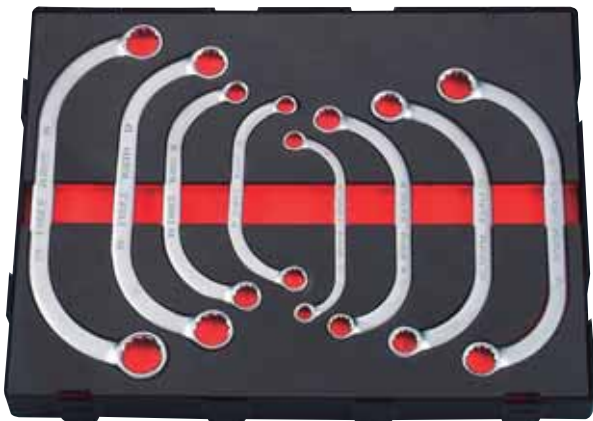

### K50820



#### 8pc Half-moon ring wrench set

Part no.	6/10.6/11.6/1.5'	1772g
Content:		
761 0810...1922	8-Half-moon ring wrench	
	8x10; 10x12; 11x13; 12x14; 13x15;	
	16x18; 17x19; 19x22 mm	

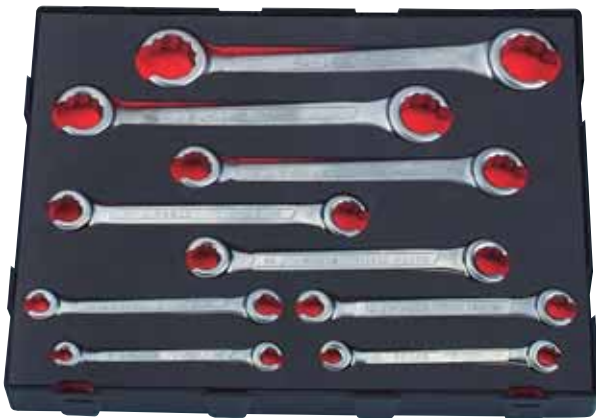

### K50914



#### 9pc Flare nut wrench set

Part no.	6/15.3/16.3/1.5'	2548g
Content:		
751 0810...3032	9-Flare nut wrench	
	8x10; 9x11; 11x13; 12x14; 16x18;	
	17x19; 19x22; 24x27; 30x32 mm	

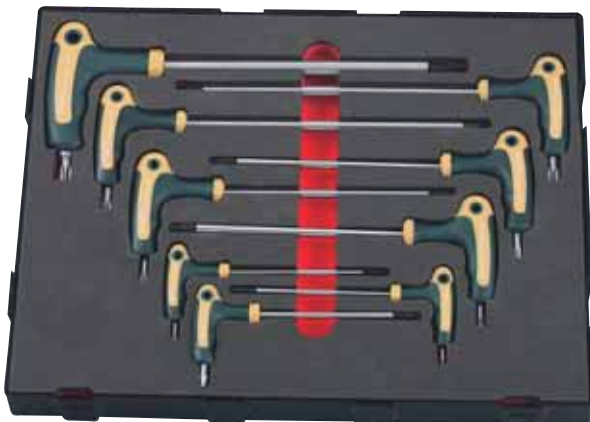

### K50915

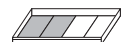

#### 9pc Star & star-tamper grip key set

Part no.	6/10.6/11.6/1.5'	1772g
Content:		
767 10G...50G	9-Star & star-tamper grip key	
	T10xT-10H; T15xT-15H; T20xT-20H;	
	T25xT-25H; T27xT-27H; T30xT-30H;	
	T40xT-40H; T45xT-45H; T50xT-50H	

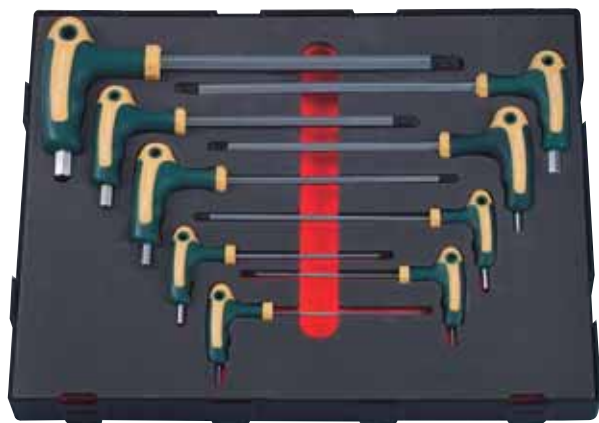

## K50916



### 9pc Hex & Hex-ball grip key set

Part no.	6/10.6/11.6/1.5'	1772g
765 02G...10G	Content: 9-Hex & Hex-ball grip key 2; 2.5; 3; 4; 5; 6; 7; 8; 10 mm	



## K5104



### 10pc Hinged socket wrench set

Part no.	6/21.3/22.3/1.5'	3548g
752 0607...2427	Content: 10-Hinged socket wrench 6x7; 8x9; 10x11; 12x13; 14x15; 16x17; 18x19; 20x22; 21x23; 24x27 mm	

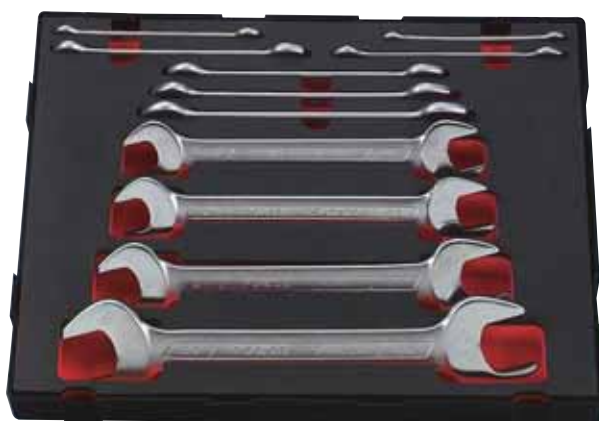

## K5111

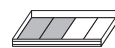

### 11pc Double open end wrench set

Part no.	6/16.8/17.8/1.5'	2800g
754 0607...3032	Content: 11-Double open end wrench 6x7; 8x9; 10x11; 12x13; 14x15; 16x17; 18x19; 20x22; 21x23; 24x27; 30x32 mm	



## K51210F



### 12pc Flexible gear wrench set

Part no.	6/14.4/15.4/1.5'
757 08F...19F	Content: 12-Flat gear wrench 8; 9; 10; 11; 12; 13; 14; 15; 16; 17; 18; 19 mm



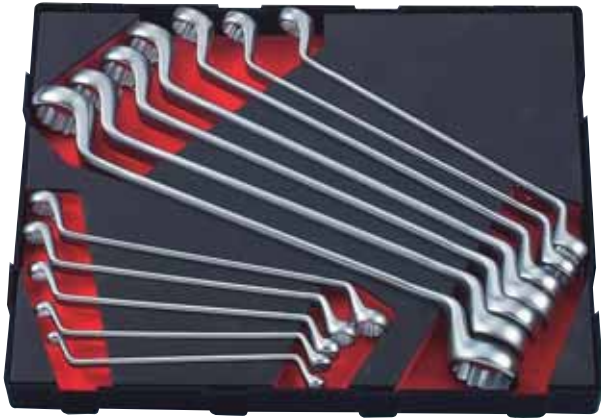

## K51218

### 12pc 75° offset ring wrench set

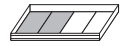

Part no.	6/24.2/25.2/1.5'	4028g
759 0607...3032	Content: 12-75° offset ring wrench 6x7; 8x9; 10x11; 12x13; 14x15; 16x17; 18x19; 21x22; 23x26; 24x27; 25x28; 30x32 mm	

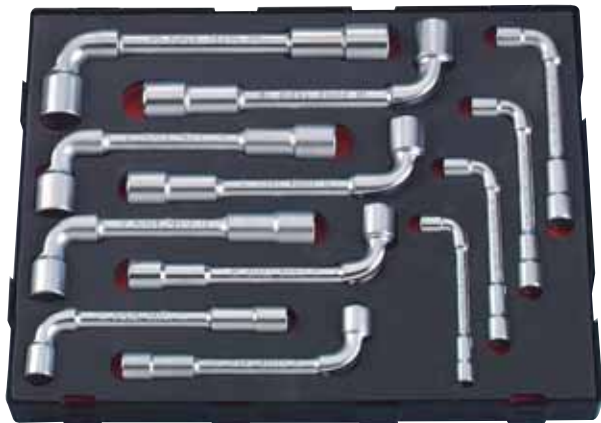

## K51219

### 12pc Angle wrench set

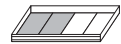

Part no.	6/23/24/1.5'	3839g
753 08...22	Content: 12-Angle wrench 6pt.-6pt. 8; 10; 11; 12; 13; 14; 15; 16; 17; 18; 19; 22 mm	

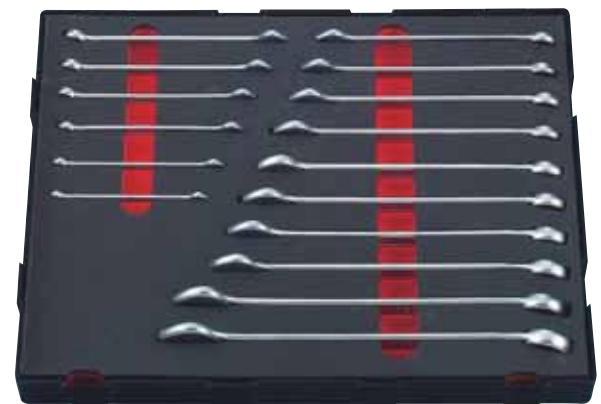

## K5165

### 16pc Combination wrench set

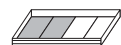

Part no.	6/14.3/15.3/1.5'	2380g
755 06...22	Content: 16-Combination wrench 6; 7; 8; 9; 10; 11; 12; 13; 14; 15; 16; 17; 18; 19; 21; 22 mm	

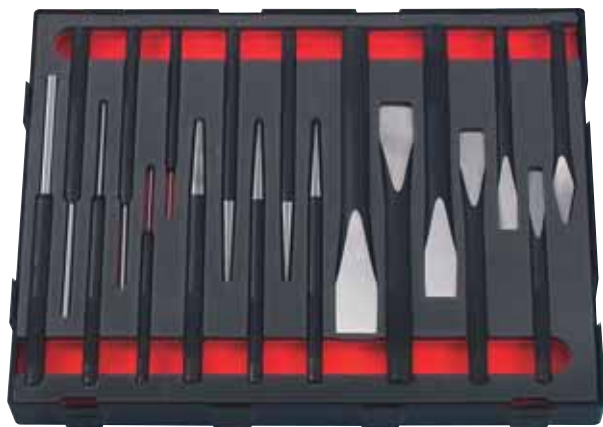

## K5183

### 18pc Chisel & punch set

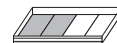

Part no.	6/19.2/20.2/1.5'	3200g
602 10150...25220	Content: 6-Chisel 10(150mmL); 12(150mmL); 15(180mmL); 19(200mmL); 22(200mmL); 25(220mmL)	
603150	1-Cape Chisel 150mmL	
604 2140...8215	6-Pin punch 2(140mmL); 3(150mmL); 4(190mmL); 5(200mmL); 6(210mmL); 8(215mmL)	
606 4185...8185	4-Taper punch 4(185mmL); 5(185mmL); 6(185mmL); 8(185mmL)	
6074185	1-Center punch 4(185mmL)	



## K5193

### 19pc File & nut splitter set

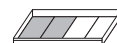

Part no.	6/18/19/1.5'	3008g
5056P1	Content: 1-8" Flat file	
5056P2	1-8" Half round file	
5056P3	1-8" Round file	
5056P4	1-8" Square file	
5056P5	1-8" Triangular file	
63005	5-Screw extractor 7/64"; 9/64"; 5/32"; 1/4"; 19/64"	
672 0912...1622	3-Nut splitter 5/16" - 1/2" (9-12mm); 1/2" - 5/8" (12-16mm); 5/8" - 7/8" (16-22mm)	
5096P5	1-Screw pitch gauges 0.25-6(Metric)	
5096P6	1-Screw pitch gauges 4-62(SAE)	
818 06...	4-Stud extractor 6; 8; 10; 12 mm	



## K5204

### 20pc Reversible gear wrench & holder set



Part no.	6/19.2/20.2/1.5'	3200g
757 08R...23R	Content: 16-Reversible gear wrench 8; 9; 10; 11; 12; 13; 14; 15; 16; 17; 18; 19; 20; 21; 22; 23 mm	
831 210...419	3-Gear wrench socket holder 1/4"DR.(10mm); 3/8"DR.(13mm); 1/2"DR.(19mm)	
831H210	1-Gear wrench bit holder 1/4"Hex(10mm)	



## K913G5



### 13pc Spark plug maintenance kit

Part no.	6/16.3/17.3/1.5'	2720g
Content: 3/8"DR.		
8323 18...24	2-Torque adapter 18Nm; 24Nm	
802318	1-Flexible ratchet handle	
8073 16M...20.6M	2-Magnetic spark plug socket 16; 20.6 mm	
8043150	1-Extension 150mm-6"	
61802	1-26 sizes Feeler gauges (SAE & Metric)	
63001	1-Spark plug hole thread chaser	
63004	1-14mm Spark plug hole rethreader	
9U3001	1-Brass & Nylon scrape brushes	
9G3101	1-Calibrated ignition tester (HEI system)	
9G3102	1-Calibrated ignition tester (Standard system)	
9G0107	1-Spark plug boot pliers	



## K913M1



### 13pc Auto glass maintenance kit

Part no.	6/12.2/13.2/1.5'	2035g
Content:		
9M0501	Windshield cut-out wire (stainless steel, square)	
9M2901	Wire guide	
902M2	2pc Wire gripping handles (Quick release)	
9M2902	Wire starter	
9M2903	Music wire piercing tool	
5055P401	Utility knife	
5055P401-P	5pc Spare blades for 5055P401	
9U2102	Scraper with dual-material grip (12mm blade)	
9U2102-12	5pc Blade 12mm	
9U2102-16	5pc Blade 16mm	
9U2102-16A	5pc Blade bevelled 16mm	
9U2102-20	5pc Blade	

# General Information

This catalogue replaces all previous editions. All rights reserved in all countries. Reprinting and excerpts require a prior permission in writing by Shyang Yun Tools Co., Ltd.

The photographs and the technical details are of the articles at present offered.

Since we are constantly updating and improving our products to meet user needs and technological developments, we reserve the right to make modifications and changes with regard to photographs, specifications, sizes, packing, weights and performance without notice.

There is no liability for printing errors and correction or replacement supplies with regard to products already delivered. Cancellations of all models and sets may be made at any time without there being any grounds for legal claim.

FORCE is a registered trademark

© Copyright by Shyang Yun Tools Co., Ltd.

All rights reserved.



**FORCE**®



**Shyang Yun Tools Co., Ltd.**  
**Shyang Yun Hardware Co., Ltd.**

No.161, Sitou Rd., Shengang Township Taichung County,  
Taiwan 429

Tel:+886-4-25631268 Fax:+886-4-25632678

<http://www.force.com.tw> Email:[info@force.com.tw](mailto:info@force.com.tw)